

World's Best Dental Imaging Company

PaX-Primo

User Manual





Table of Contents

| | | |
|------------------|--|-----------|
| Chapter 1 | Introduction..... | 5 |
| 1.1 | Conventions in this guide..... | 5 |
| 1.2 | Note to the user..... | 5 |
| 1.3 | Warning and safety instructions | 6 |
| Chapter 2 | PaX-Primo i Imaging system overview | 8 |
| 2.1 | System features | 8 |
| 2.2 | Analytical programs supported | 10 |
| 2.3 | Imaging system construction..... | 11 |
| 2.4 | Entering the specific, capturing mode..... | 13 |
| 2.5 | Functional distribution of roles | 15 |
| 2.6 | General view of the PaX-Primo i | 16 |
| 2.7 | Exposure switch..... | 17 |
| 2.8 | Replacement parts and positioning accessories..... | 18 |
| Chapter 3 | Imaging software overview | 19 |
| 3.1 | PC system requirements | 19 |
| 3.2 | Software overview | 20 |
| 3.3 | Touch pad screen(LCD) overview | 22 |
| 3.3.1 | Main screen | 22 |
| 3.3.2 | Standard Mode..... | 24 |
| 3.3.3 | Special Mode | 25 |
| 3.3.4 | TMJ Mode..... | 26 |
| 3.3.5 | Sinus mode..... | 27 |
| 3.3.6 | Setting mode..... | 28 |
| 3.4 | Exposure time for each mode..... | 29 |

| | | |
|------------------|---|-----------|
| Chapter 4 | Getting started | 30 |
| 4.1 | Starting the image viewer software | 30 |
| 4.2 | Creating a patient record | 30 |
| 4.3 | Turing on the PaX-Primo i | 31 |
| 4.4 | Calling the imaging software | 32 |
| 4.5 | Selecting the medium for the image transfer | 33 |
| | | |
| Chapter 5 | Acquiring images | 34 |
| 5.1 | Acquiring <i>Standard Panoramic</i> image | 34 |
| 5.1.1 | Preparing the unit and setting the acquisition parameters | 34 |
| 5.1.2 | Preparing and positioning the patient | 35 |
| 5.1.3 | Preparing for launch of X-Ray | 40 |
| 5.1.4 | Launching the exposure | 42 |
| 5.1.5 | Post-processing on the PC | 44 |
| 5.2 | Acquiring <i>TMJ</i> (Temporomandibular Joint)image..... | 46 |
| 5.2.1 | Preparing the unit and setting the acquisition parameters | 46 |
| 5.2.2 | Preparing and positioning the patient | 47 |
| 5.2.3 | Preparing for launch of X-Ray | 52 |
| 5.2.4 | Launching the exposure | 52 |
| 5.2.5 | Post-processing image on the PC | 53 |
| 5.3 | Acquiring <i>Sinus</i> image | 55 |
| 5.3.1 | Preparing the unit and setting the acquisition parameters | 55 |
| 5.3.2 | Preparing and positioning the patient | 56 |
| 5.3.3 | Preparing for launch of X-Ray | 61 |
| 5.3.4 | Launching the exposure | 61 |
| 5.3.5 | Post-processing image on the PC | 61 |
| 5.4 | Acquiring <i>Special Panoramic</i> image..... | 63 |
| 5.4.1 | Preparing the unit and setting the acquisition parameters | 63 |
| 5.4.2 | Preparing and positioning the patient | 64 |
| 5.4.3 | Preparing for launch of X-Ray | 69 |
| 5.4.4 | Launching the exposure | 69 |
| 5.4.5 | Post-processing image on the PC | 69 |
| 5.4.6 | Sample images of Special mode | 71 |



| | | |
|------------------|---|-----------|
| Chapter 6 | Upgrading to the imaging system with auto-focusing capability..... | 73 |
| 6.1 | The imaging modes with the AUTO FOCUSING implementation supported..... | 73 |
| 6.2 | How the AUTO FOCUSING(AF) mode works..... | 74 |
| 6.2.1 | Reconstructing procedures..... | 74 |
| 6.2.2 | Graphical explanation..... | 75 |
| 6.2.3 | Typical example..... | 76 |
| 6.2.4 | Comparisons between standard and AUTO FOCUSING imaging..... | 77 |
| Chapter 7 | Maintenance..... | 80 |
| 7.1 | Storage and transportation..... | 80 |
| 7.2 | Sterilization and disinfection..... | 80 |
| 7.3 | Regular maintenance and treatment..... | 80 |
| 7.4 | Regular checkup..... | 80 |
| 7.5 | General Notes..... | 81 |
| 7.5.1 | Preoperational stage..... | 81 |
| 7.5.2 | In-use stage..... | 81 |
| 7.6 | X-Ray generation and warning..... | 81 |
| 7.7 | Daily maintenance tasks..... | 82 |
| Chapter 8 | Technical specifications..... | 83 |
| 8.1 | Unit technical specifications..... | 83 |
| 8.1.1 | General information..... | 83 |
| 8.1.2 | X-ray Generator..... | 84 |
| 8.1.3 | X-ray Tube(Toshiba D-051)..... | 84 |
| 8.1.4 | Electrical Characteristics..... | 84 |
| 8.1.5 | Dimension of beam limiting device: collimator..... | 85 |
| 8.1.6 | Environmental Characteristics..... | 85 |
| 8.1.7 | Dimension of the Unit..... | 86 |
| 8.1.8 | Focal spot distance..... | 87 |

| | | |
|-------------------|--|-----------|
| 8.2 | X-Ray generator technical specifications..... | 88 |
| 8.2.1 | X-Ray Tube Specification | 88 |
| 8.2.2 | High voltage generator | 89 |
| 8.2.3 | X-Ray generation controller | 89 |
| 8.2.4 | Beam limiter and its dismantled view | 89 |
| 8.3 | Classification | 90 |
| 8.4 | Standards | 90 |
| 8.5 | Marks & Graphic symbols..... | 90 |
| Chapter 9 | Service..... | 91 |
| Chapter 10 | Disposal of the Unit | 91 |
| Chapter 11 | Emergency Measures | 92 |
| Chapter 12 | Recommended X-Ray Exposure Table..... | 93 |
| 12.1 | Pano Standard | 93 |
| 12.2 | Pano Special..... | 93 |



Chapter 1 Introduction

This user manual contains a description, installation of imaging software, operational instructions and other useful information for the PaX-Primo *i* digital imaging system.

1.1 Conventions in this guide

The following symbols will be used throughout this manual for the users to keep better comprehension of their meaning. Make sure that you fully understand them and obey the instructions they contain.



This symbol indicates a note to help you get the best performances from the system. Carefully read these notes to bring about the best performance possible.



This symbol indicates a warning that should be obeyed with extreme cares. When missed, it may cause severe damage or physical injuries.



The radiation symbol warns you about radiation dangers.



This indicates a compulsory action or instruction.

1.2 Note to the user



X-Ray can be harmful and dangerous if not used properly. The instructions and warnings contained in this manual must be carefully followed.

As a manufacturer of radiology equipments that conform to stringent protection standards in force throughout the world, we guarantee a maximum degree of protection against radiation hazards.



The room in which your radiology unit is to be installed must comply with all official regulations applicable to protection against radiation. You must install your radiology unit in a room protected against X-ray emission.

1.3 Warning and safety instructions

An extreme care must be paid when operating this system, since this involves high voltage, electrical parts inside unit.

To use and operate your panoramic unit and your digital imaging software you must follow the instructions contained in this manual.

Most of all, the following two things cannot be overstated.

| | |
|--|--|
|  | <p>Never expose this equipment to watery material or spray that may lead to an electrical shock or a damage of equipment.</p> |
|  | <p>A small amount of Laser beam could lead to permanent eye injuries. For maximum safety, advise the patient <i>not</i> to look into the laser beam directly. And while making adjustments; be sure that beam is not directed into the patient's eyes.</p> |



1. You are responsible for the operation and maintenance of this unit. Only legally qualified persons can operate this unit. **DO NOT** open the cover of the unit.
When necessary, have a trained authorized service technician carry out inspection and maintenance operations.
2. Install this Unit in an x-ray room that complies with current installation standards. From this location, you must be able to maintain visual or audio communication with the patient. This Unit must be permanently connected to the ground with a fixed power supply cable.
3. **DO NOT** place the PC and the peripheral equipment connected to it in the immediate vicinity of the patient in the Unit. Leave at least 1.5 m distance between the patient and the Unit.



4. Leave a sufficient amount of clear space around the CPU to ensure that it is properly ventilated.
5. X-ray equipment is hazardous to patients and the operator if you do not observe the exposure safety factors and operating instructions.
6. The patient should wear a protective lead-lined shoulder apron, unless other Radiation Protection Protocols apply locally.
7. Disinfect any parts of the Unit that come into contact with the patient and the operator after each patient has been exposed to x-rays.
8. While adjusting the height of the Unit, ensure that the patient is kept clear of the mechanism.
9. When the Unit is not in use, ensure that the ON/OFF switch is set to OFF (O).
10. Ask the patient to remain still until the Unit arm has stopped moving and the RESET movement has completed.
11. DO NOT use this Unit in conjunction with oxygen-rich environments. This Unit is not intended for use with flammable anesthetics or flammable agents.

Chapter 2 PaX-Primo *i* Imaging system overview

2.1 System features

PaX-Primo *i* is a digital, panoramic dental diagnostic system developed with especially the affordability in mind without sacrificing performances.

Equipped with a new generation of CMOS digital sensor, PaX-Primo *i* delivers diagnostic panoramic x-ray images equal to digital photo quality. Also available is the PaX-Primo *i* with optional Adaptive Layer Mode Panoramic Algorithm functionality to produce optimal digital diagnostic images by using VATECH's proprietary Area Adaptive Mode (AAM) solution. The AAM solution captures and instantly processes multiple oral trough layers during a single panoramic scan. It intelligently reproduces a final diagnostic image by selecting the optimal single layer in different regions of the image to minimize image distortion in every panoramic image taken. Both the PaX-Primo *i* includes a high resolution 10.4" LCD touch panel for easy operation and simple image previewing. The very compact size and light weight of the PaX-Primo *i* family (less than a 4' cube, and weighing less than 165 pounds), and the ease of installation will be appreciated by both dentists and dealers. This equipment provides various features such as the followings.

Among them:

1. Adopting AUTO FOCUSING(Adaptive Layer Mode Panoramic Tomography) algorithm that enables the system to
 - focus automatically on the object, using artificial intelligent algorithm
 - acquire high quality images, regardless of the Arch shape and positioning of the patient
2. Adopting AAM (Area Adaptive Mode) to minimize image distortion caused from inappropriate pose in panoramic mode.
3. Providing higher image resolution produced by the advanced CMOS-type sensor that is made for exclusive use in the panoramic imaging.



4. Providing wide touch screen of 10.4" to streamline series of procedures from patient positioning, to image saving to image reading, thus leading to easier-to-manipulation than ever before.
5. Improving reliability and dependability by adopting CAN (controlled area network) protocol that generally is used in areas like airplane leading to greatly reduced problem occurrences.
6. Positioning patients more accurately in a way that the operator and patient face each other, resulting in creating much less distorted images.
7. The PaX-Primo *i* has been designed to carry out the following radiological examinations.
 - Standard
 - Sinus
 - TMJ
 - Special panoramic

2.2 Analytical programs supported

The following table summarizes the anatomical programs that PaX-Primo *i* supports.

| Mode | Basic | | Intelligent | |
|---------------|--------------------|----------|---------------------|----------|
| | Resolution | Sub-mode | Resolution | Sub-mode |
| Standard mode | High | Normal | High <i>i</i> | Adult |
| | | Narrow | | Child |
| | | Wide | | |
| | | Child | | |
| | Normal | Normal | Normal <i>i</i> | Adult |
| | | Narrow | | Child |
| | | Wide | | |
| | | Child | | |
| Special mode | Segment horizontal | | | |
| | Segment vertical | | | |
| | Bitewing | | | |
| | Orthogonal | | Orthogonal <i>i</i> | |
| TMJ mode | Lateral Open | | | |
| | PA Open | | | |
| | Lateral Close | | | |
| | PA Close | | | |
| Sinus mode | PA | | | |
| | Lateral | | | |



The symbol *i* signifies Intelligence mode is supported.

The equipment's standard model does not support the auto-focusing intelligent mode capability.



2.3 Imaging system construction

There are two different configurations, depending on how the image acquired from the PaX-Primo *i* is delivered to the PC for post-processing and viewing. The first configuration makes use of the **Ethernet**, whereas the second one is to use the **USB card**. Each peculiar situation requires the unique configuration, as the following figures show—mainly the Ethernet availability between the PC and the equipment. Both configurations do not require the frame grabber cable for the data transmission any longer. Therefore, there is no need for both PC and the equipment to be as close as possible to obtain the error-free image.

First the former configuration is explained with data flow algorithm.

The following figure depicts the general direct connection for configuration of the PaX-Primo *i* along with the PC through the Ethernet network.

1. PC and the PaX-Primo *i* connected through the Ethernet

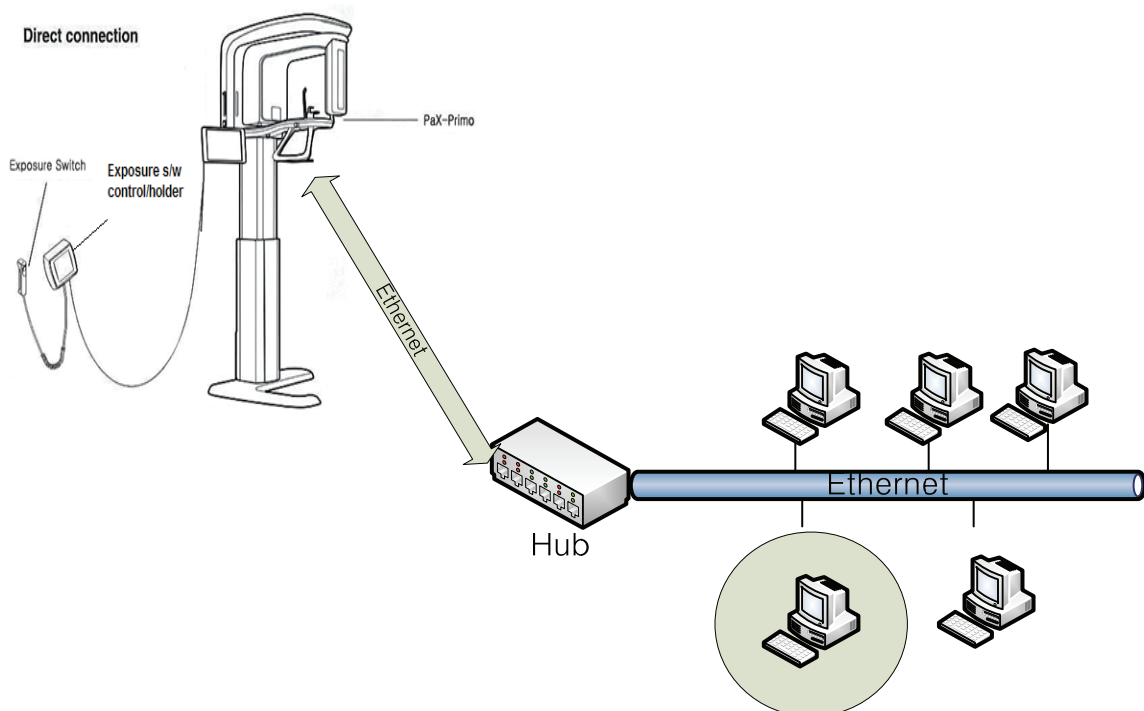

Data Flow chart

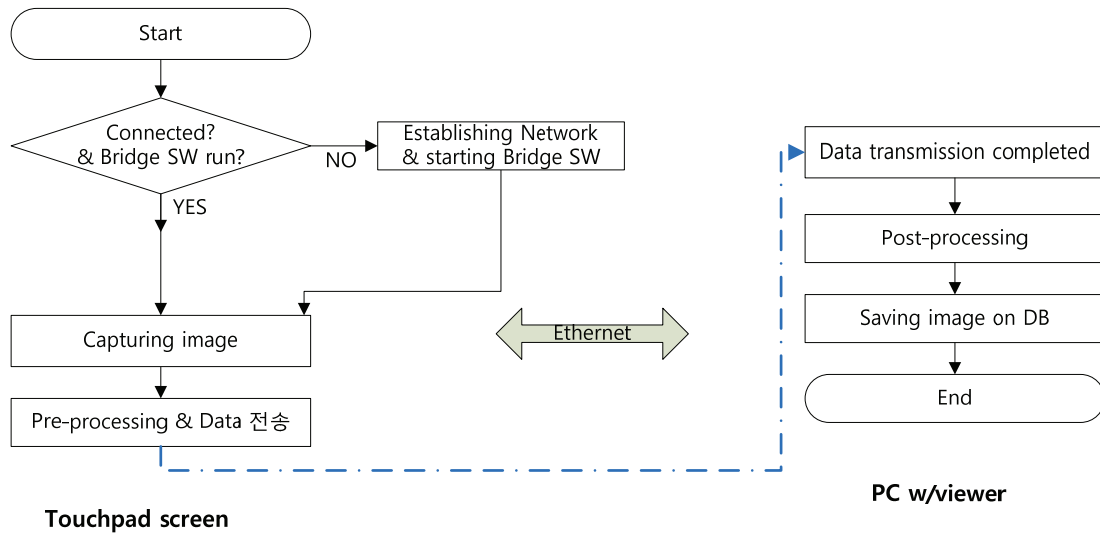

Please do not exit the running image capture program while saving the captured image on DB. If it is the case, then the captured image got damaged and you need to retake it again.

Secondly the latter configuration is explained.

2. No Ethernet network is available

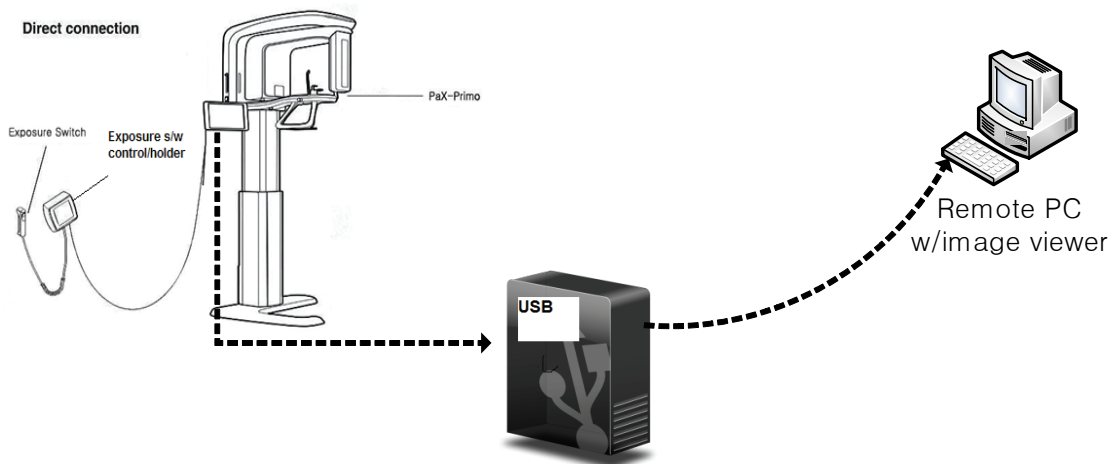



Data Flow chart

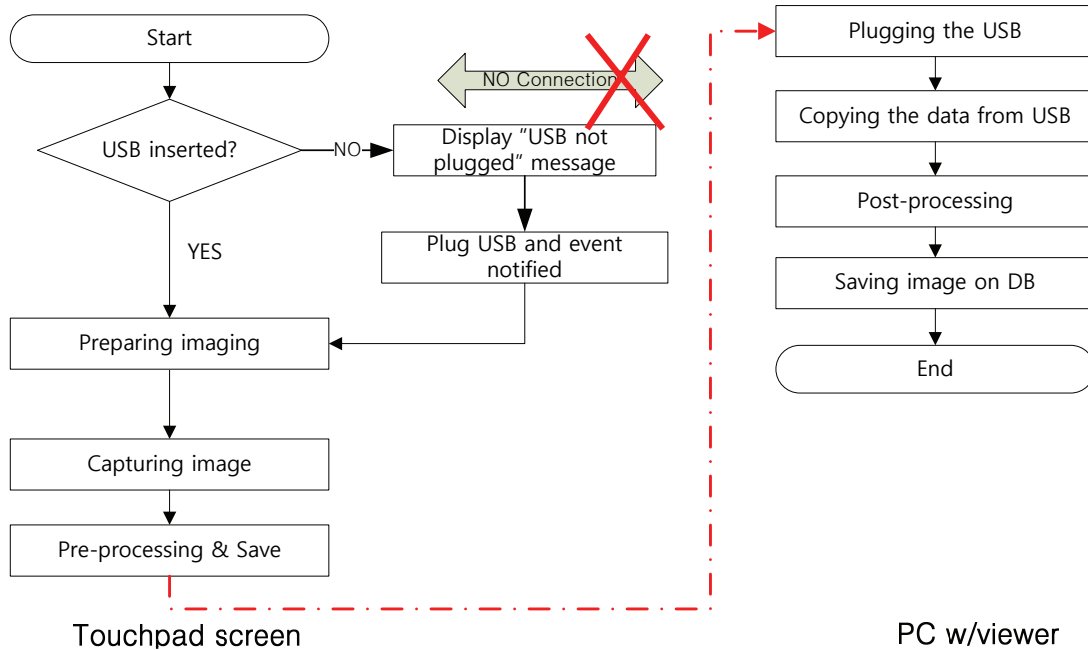

This configuration arises when the network between the Unit and PC is not available. The USB media plays the role of the network to deliver the image from the Unit to PC. The slot for the USB card is located on the bottom of the touchpad screen and the USB card is able to *save only one shot of the image at a time*.

For the image taken to be analyzed, one detaches the SD card (USB) off from the equipment and brings it where the PC is available with the image viewer—for post-processing.

2.4 Entering the specific, capturing mode

Currently the automatic recognition between the USB and the network is not supported, which means that *manual selection* for either USB or Network is required

To select either one, proceed with the following steps.

1. Turn on the PC.
2. On your desktop, double-click **EasyDent** or **Start>All Programs>EasyDent**.
Then a blank EasyDent main screen will be displayed.

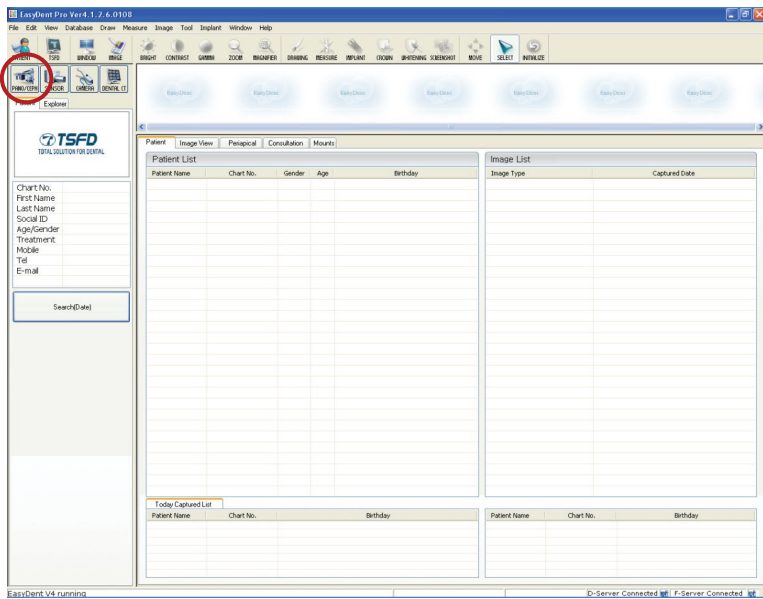

- From the main screen, click the **Pano** icon (Red circle) on the upper left the screen to run the imaging capture program. Then the following main screen will be displayed

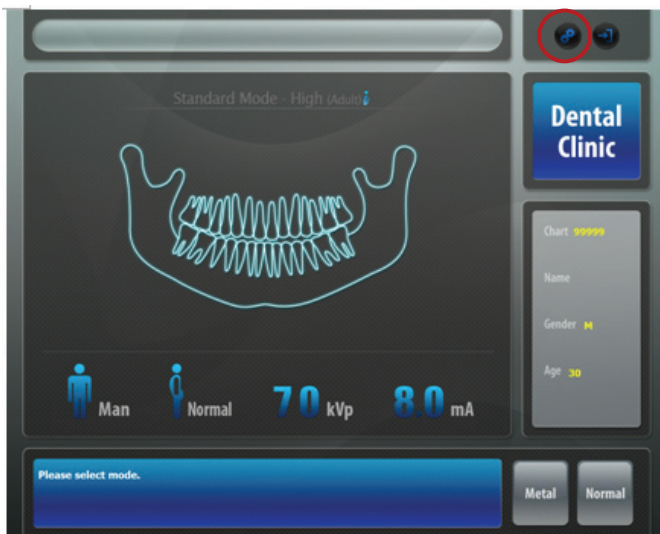

- From the above figure, click the button in red circle and you are asked to enter the password. Enter the “vatech” in the lower cases for all.

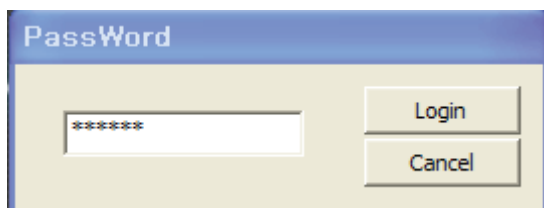



- The following figure will appear. And go down to the lower right corner to select your choice from three types.

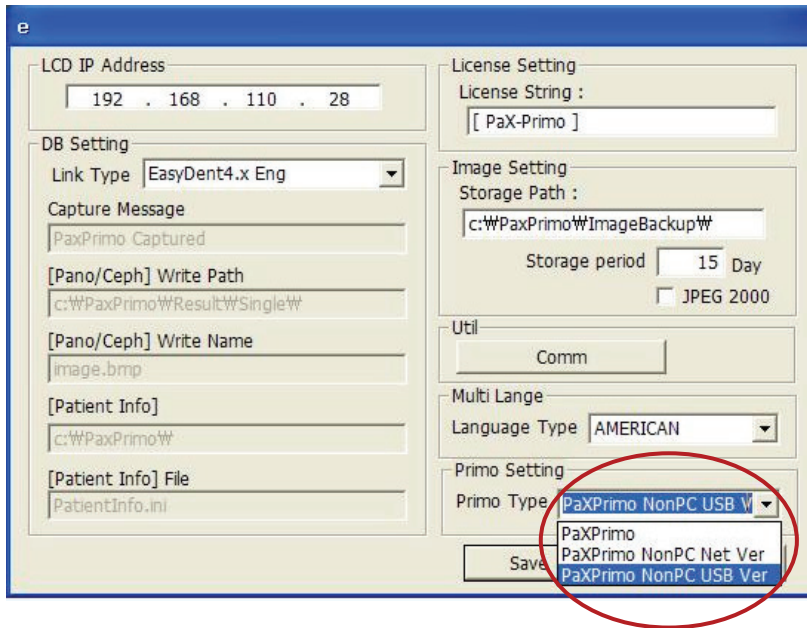

- Lastly, save the setting.
Now you are ready to start off.

2.5 Functional distribution of roles

| From the Touch pad screen(LCD) | From the Imaging software of the PC |
|--|--|
| <ul style="list-style-type: none"> Control the unit operation | <ul style="list-style-type: none"> communicate with LCD via Ethernet |
| <ul style="list-style-type: none"> Communicate with imaging software on the PC via Ethernet | <ul style="list-style-type: none"> acquire image when it is in Ready state |
| <ul style="list-style-type: none"> Firmware upgrade | <ul style="list-style-type: none"> save the acquired image in DB that is interfaced with the patient management program |

2.6 General view of the PaX-Primo *i*

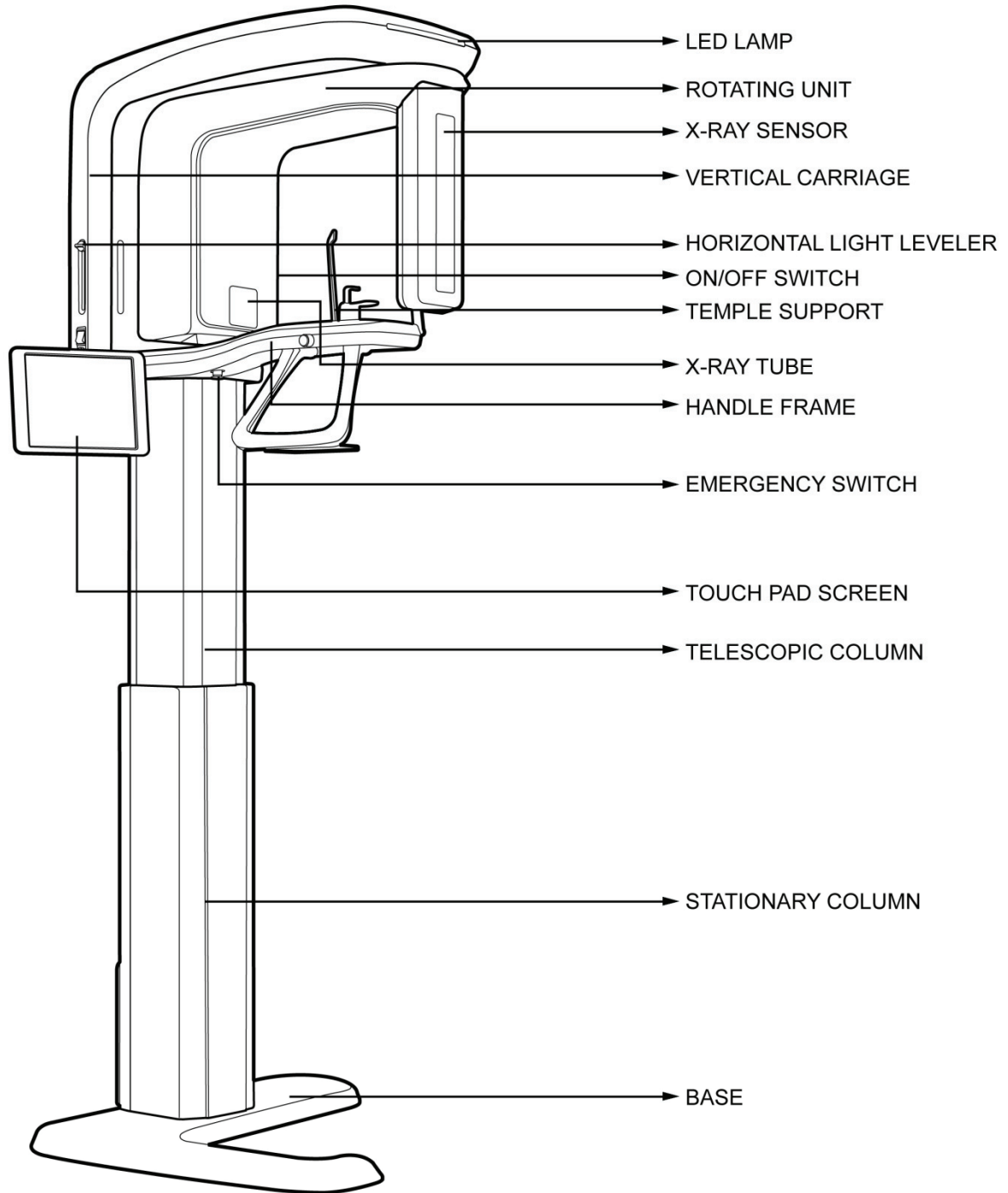



Each functional description

- **LED LAMP:** Indicates current exposure activity (green light when not in operation, but turn into orange color while x-raying)
- **ROTATING UNIT:** moves to the proper position and turns around patient's head during exposure.
- **X-RAY SENSOR:** used to detect a dose of X-Rays through the patient and converts it into electrical signal.
- **HORIZONTAL LIGHT LEVELER:** adjusts horizontal light to the Frankfort line to position patient in optimal way.
- **ON/OFF SWITCH:** turns on and off the equipment.
- **TEMPLE SUPPORT:** supports the patient so as to acquire optimal image in panoramic mode.
- **EMERGENCY SWITCH:** for safety reasons, this is used to terminate power to equipment by pressing this button when a fault occurs. Its primary use is to protect humans and equipment from a severe injuries and damages.
- **TOUCH PAD SCREEN:** allows the operator to control certain unit functions by touching screen. It also displays the operating parameters and some texts messages.
- **TELESCOPIC COLUMN:** this part of column moves up and down to be adjusted to patient height.
- **STATIONARY COLUMN:** this part of the column is fixed to the base.
- **BASE Plate:** used to balance and stabilize the whole equipment

2.7 Exposure switch

The exposure switch enables you to launch a radiological image acquisition via the exposure button from outside the X-Ray room. You press and hold the exposure switch button until the end of acquisition. Premature release of exposure switch button interrupts acquisition.

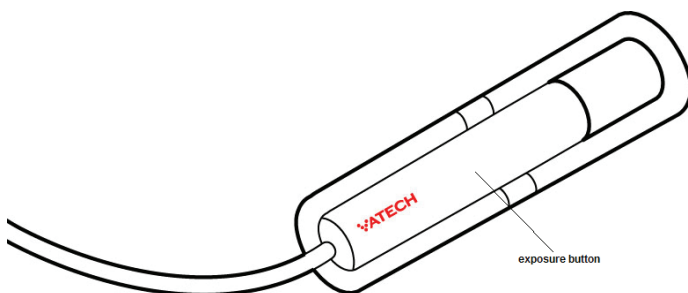

2.8 Replacement parts and positioning accessories

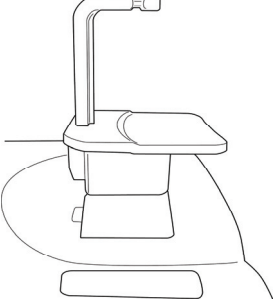
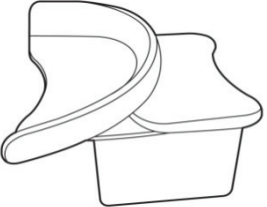
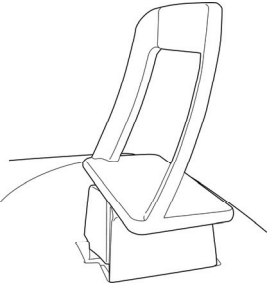
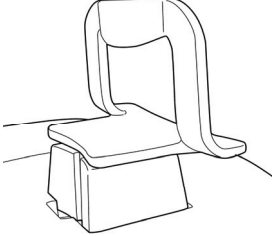
| Accessory | Description |
|---|-----------------------------------|
|  | <p>Normal bite</p> |
|  | <p>Support for the edentulous</p> |
|  | <p>TMJ support</p> |
|  | <p>Sinus support</p> |



Chapter 3 Imaging software overview

3.1 PC system requirements



It is mandatory to check that the PC system configuration is compatible with the PC system requirements for the PaX-Primo i. If necessary, you must update your PC system configuration. DO NOT place the PC and the peripheral equipment connected to it in the immediate vicinity of the patient in the Unit. Leave at least 1.5 m distance from the Unit.

| Item | Minimum PC Requirements | Recommended end product(HP DX2810):Note | Comments |
|---------------------------|---|--|--|
| CPU | Intel Core2Duo E7300 2.66GHz or higher | Core 2Duo E7400 Processor | |
| RAM | 2 GB DDR2 or above | 2GB PC2-6400 (DDR2-800) | RAM has a major impact on system performance. |
| Hard disk drive | 250 GB or higher | 250GB SATA NCQ SMART IV HDD | |
| Graphic card | 128 M 128bits | 128 M 128bits | The video RAM has major impact on system performance. |
| Monitor | 19" or larger 1024 x 768 minimum screen resolution - 32 bits color mode | 19" 1024 x 768 minimum screen resolution | Monitor is a vital in displaying quality images. Low-quality screens will prevent you from proper diagnoses and treatment. |
| Operating system | Windows XP / Vista | Windows XP / Vista | |
| Ethernet interface | 1 Ethernet interface w/ 100Mbps | Broadcom 5751 Netxtreme Gigabit PCIe NIC | Communication between PC and Unit |
| CD/DVD drive | A CD-ROM drive is required to install the product. | A CD-ROM drive is required to install the product. | |



We do not endorse the company's opinion by mentioning the specific model. This model is mentioned here for its stability and dependability during our test with the equipment for a long period of time

3.2 Software overview

The following figure shows initial view of imaging software running *on the PC*.



For operating the PaX-Primo *i*, primarily all the operations are carried out on the Touch pad screen. And this program runs in passive way, just displaying images acquired. That is, this works as an image viewer.

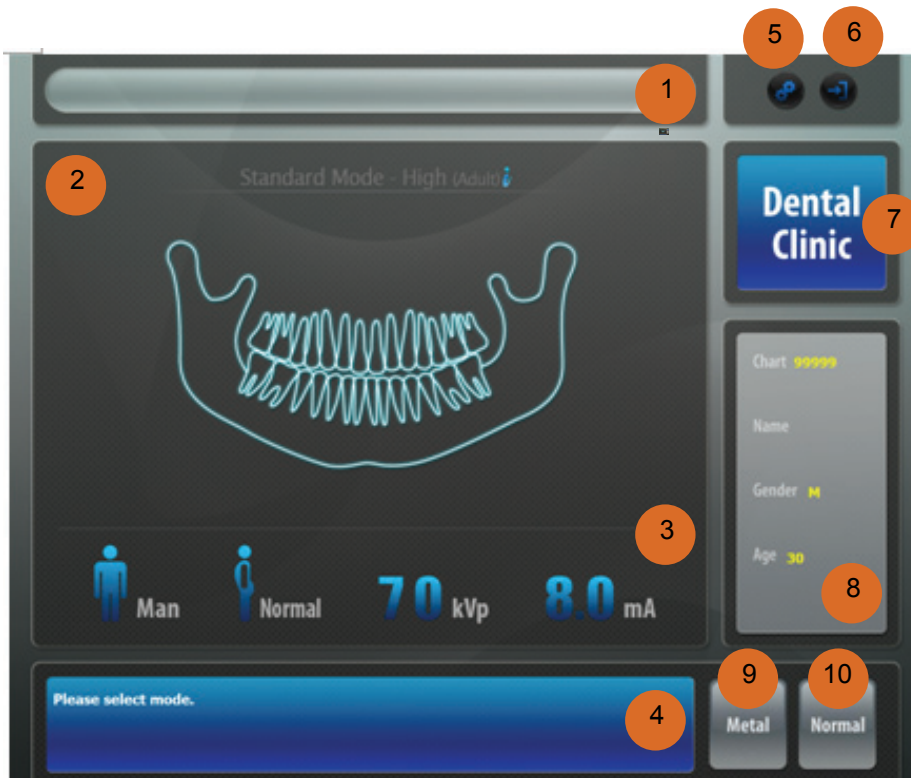

1. **Progress bar:**

Shows the progress status, with a graph, during imaging and image processing

2. **Window for image:**

Shows the captured image on real time. The window shows a reference-only drawing of the image



3. **Pane for the selected parameters display:**
Shows tube voltage, kVp and tube current, mA, set through the touch pad screen.
4. **Information window:**
Shows various kinds of text instruction messages going on currently for imaging
5. **Environmental parameters configuration:**
Enters the various parameter setting mode for the capturing program
6. **Exit Button:**
Exit the imaging program.
7. **X-ray indicator:**
Shows the x-ray activity. This whole, rectangular area turns and remains red during x-ray exposure.
8. **Patient information window:**
Shows information of the patient such as name, age, gender, and chart number that set through touch pad screen
9. **Metal:**
By clicking this button, the metal artifact reduction algorithm invoked and result will be saved in the DB.
10. **Normal**
Normal manipulation without the metal artifact reduction will be carried out and saved in the DB.

3.3 Touch pad screen(LCD) overview

Below is a picture that shows and describes each unique mode in which relevant functions are selected and some parameters are configured. To make a selection on the LCD, simply touch the screen with finger on the text field or icons.

3.3.1 Main screen



- ① **Mode selection information window:**
Displays the currently selected information such as imaging mode, patient type, and X-ray setting values set at each mode.
- ② **Standard mode selection:**
Select the standard imaging mode
- ③ **TMJ mode selection:**
Select the special imaging mode among **Lateral Open**, **PA Open**, **Lateral Close**, and **PA Close**.
 - Lateral Open: will take image in a projection view from the side of patient with the mouth opened



- PA Open: will take image of the Posterior-Anterior open view
 - Lateral Close: will take image in a projection view from the side of patient with the mouth close
 - PA Close: takes image of the Posterior-Anterior close view
- ④ **Sinus mode:**
Select imaging mode from either **PA** or **Lateral**
- PA: take images from point of posterior-anterior view of sinus
 - Lateral: take images of sinus from point of side view
- ⑤ **Special mode:**
Select the special imaging mode among
- Segment Horizontal
 - Segment vertical
 - Bitewing
 - Orthogonal
- ⑥ **Setting kVp and mA:**
Press “kVp/mA” for a fine adjustment of kVp, tube voltage value and mA, tube current value.
- ⑦ **Position:**
Turn on and off the laser beam to align the patient position before imaging.
- ⑧ **Return button:**
Return rotating unit to the initial position to start imaging at each mode.
- ⑨ **Confirm:**
Enables the parameters take effect.

3.3.2 Standard Mode

This mode is invoked by touching “Standard” on the main screen.

From this mode, you can select one specific sub modes

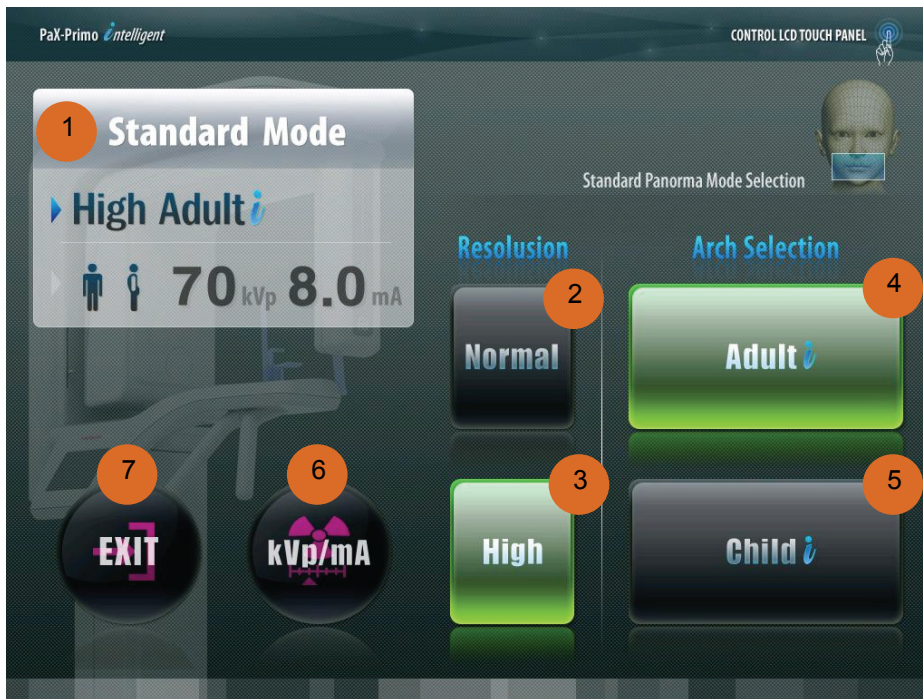

① **Mode information window**

Displays the currently selected information such as imaging mode, patient type, and X-ray setting values set at each mode.

② **Normal resolution**

Take images of the patient at normal resolution.

③ **High resolution**

Take images at high resolution.

④ **Adult *i*selection**

Take images for the adult patient in an intelligent mode

⑤ **Child *i*selection**

Take images for the child patient in an intelligent mode

⑥ **kVp/mA**

Adjust tube voltage and current for fine adjustment manually.

⑦ **EXIT**

Return to the main screen.



3.3.3 Special Mode

This mode is called up by touching the “Special” on the main window.



① **Mode information window**

Displays the currently selected information such as imaging mode, patient type, and X-ray setting values set at each mode.

② **Segment horizontal**

Take a standard dental panoramic image excluding sinus and TMJ areas.

③ **Bitewing**

Takes images for both molars

④ **Segment vertical**

Take a standard dental panoramic image showing the molars area only.

⑤ **Orthogonal *i*selection**

Press “Orthogonal” for capturing image that minimizes overlapping when the tooth overlaps. The image is taken in an intelligent mode.

⑥ **kVp/mA**

Adjust tube voltage and current for fine adjustment manually, if necessary.

⑦ **EXIT**

Return to the main screen.

3.3.4 TMJ Mode



① **Mode information window**

Displays the currently selected information such as imaging mode, patient type, and X-ray setting values set at each mode.

② **Lateral Open**

Produces open **TMJ** images in lateral view.

③ **Lateral Close**

Produces closed **TMJ** images in lateral view.

④ **PA Open**

Produces open **TMJ** images in posterior-anterior view.

⑤ **PA Close**

Produces closed **TMJ** images in posterior-anterior view.

⑥ **kVp/mA**

Touch “kVp/mA” and adjust tube voltage and current that can generate the best image for the arch of patient. This adjustment has 1 volt of resolution when changing.

⑦ **EXIT**

Return to the main screen.



3.3.5 Sinus mode



① **Mode information window**

Displays the currently selected information such as imaging mode, patient type, and X-ray setting values set at each mode.

② **PA mode**

Produces images of a posterior-anterior view of Maxillary Sinus

③ **Lateral Mode**

Produces images of a lateral view of Maxillary Sinus

④ **kVp/mA**

Select kVp and mA of X-ray manually.

⑤ **EXIT**

Return to the main screen.

3.3.6 Setting mode



Information window: shows current parameter information set by user



kVp/mA adjustment: adjusts the kVp and mA —using the up/down arrows —to reflect various patient types on the optimal exposure. Down arrow: reduce the value Up arrow: increase value

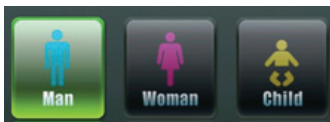

Patient gender: select the patient gender

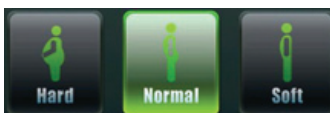

Bone density selection: select the bone density suited best for the patient



3.4 Exposure time for each mode

| Mode | Projection | Time |
|--------------------------|--------------------|------|
| Standard (High) | Normal | 13.5 |
| | Narrow | 13.5 |
| | Wide | 13.5 |
| | Child | 11.2 |
| Standard (Normal) | Normal | 9.7 |
| | Narrow | 9.7 |
| | Wide | 9.7 |
| | Child | 8.2 |
| TMJ | Lateral | 8.0 |
| | Pa | 6.5 |
| Sinus | Lateral | 7.0 |
| | Pa | 10.8 |
| Special | Segment Horizontal | 13.5 |
| | Segment Vertical | 10.2 |
| | Bitewing | 11.6 |
| | Orthogonal | 13.5 |

(Unit: second)

Chapter 4 Getting started

4.1 Starting the image viewer software

Make sure that

- All the connections between the PaX-Primo *i* and the PC are properly connected.
- The PC is turned on.

To start the imaging software, follow these steps.

1. On your desktop, double-click **EasyDent** or **Start>All Programs>EasyDent**. Then a blank EasyDent main screen will be displayed.
2. Create or open an existing patient record.

4.2 Creating a patient record

To create a new patient record, follow these procedures.

1. Run “**EasyDent**”, then the following main screen will come up.

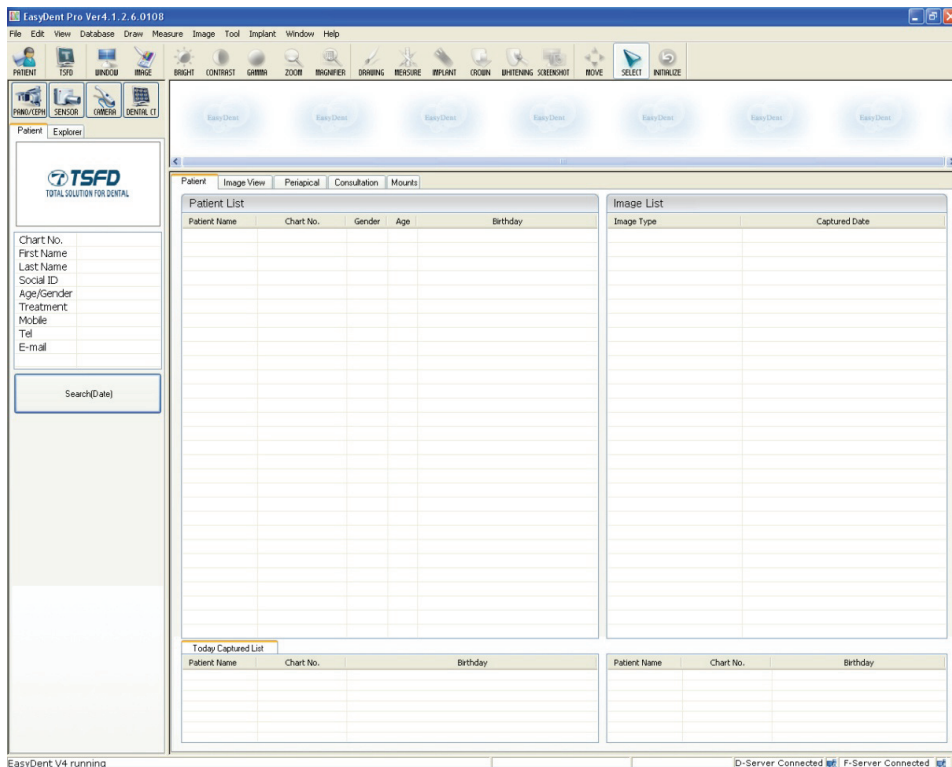



From the menu bar, select **Database>New>Add**. Then the following dialog box will pop up.



For the detailed operation on how to use this software, please refer to the EasyDent user manual.

2. Enter the required patient information. **Chart number, first name and Last name** are required fields to be filled in.
3. Other fields, although optional, are recommended to be filled in.
4. Once all the necessary parameters are entered, Click **Add** to save configurations.

4.3 Turing on the PaX-Primo *i*

Before switching on the equipment, check that installation of the unit is complete.

To switch on the unit, follow these steps.

1. Press the **ON/OFF** switch on the column.



To increase the operating life of the X-Ray tube, if the equipment has not been used for long time, you must pay special care before use.

2. Verify that name of the patient appears in the Touch pad screen.
3. Once the previous procedures are done, the equipment is now ready to be used for acquisition.

4.4 Calling the imaging software

To get access to the image capture mode, take the following steps.

1. Run **EasyDent** program.



At this point, it is supposed that you have already registered a new patient or have already chosen a patient's data from the database.

2. From the main screen, click the **Pano** icon on the upper left the screen to *run the imaging capture program*.

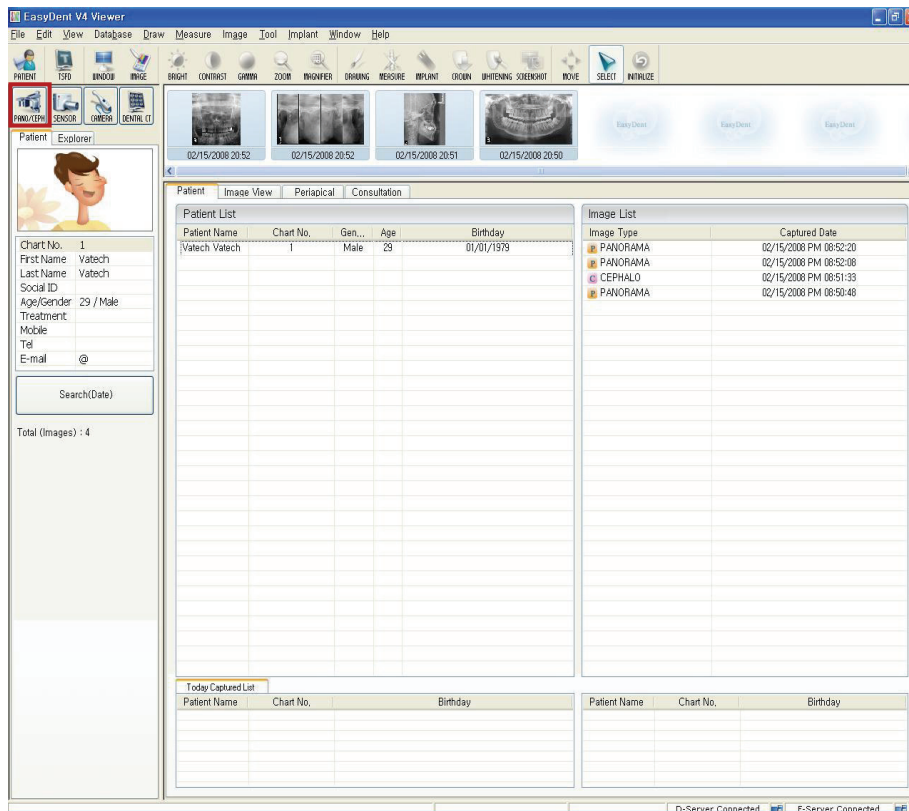



Then the following screen will appear on the desktop window.

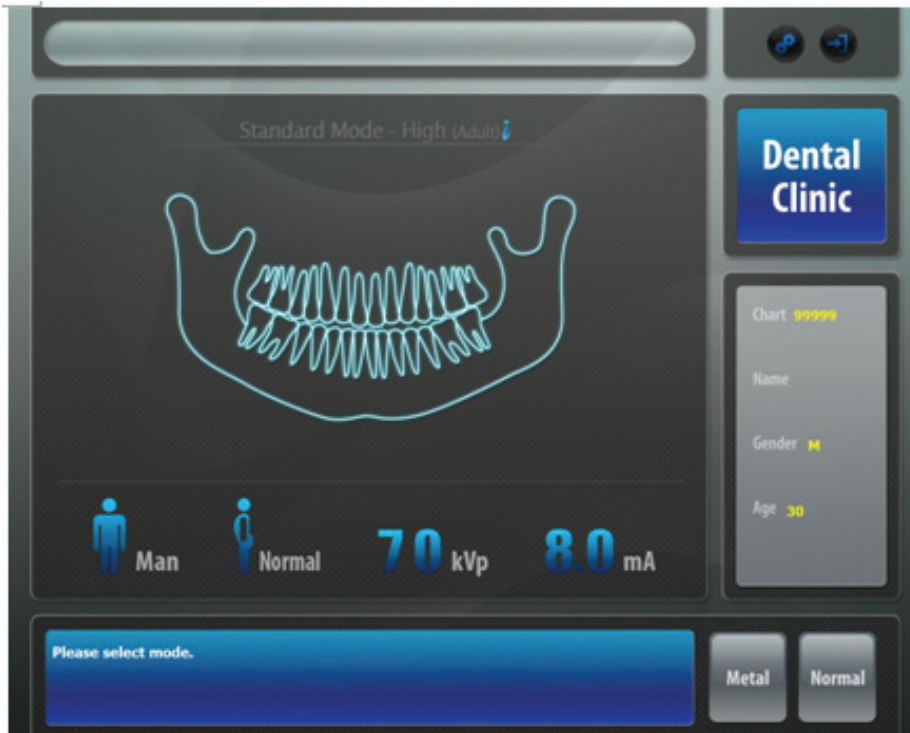

4.5 Selecting the medium for the image transfer

It is required to select either the *USB* or *Ethernet* at this moment for the acquired image to transfer.

For the further information on how-to, see the **section 2.4**



NOTE

With the PaX-Primo, the functionalities of the touch pad screen and the PC are divided in such a way that the primary function of the LCD is to control the Pax-Primo System while that of the PC is to acquire, process, and save the acquired images in DICOM format.

Naturally, more detailed description about the acquisition can be seen with the LCD than with the PC.

Chapter 5 Acquiring images

5.1 Acquiring *Standard* Panoramic image

Before acquiring image, make sure that you have:

- Reset a rotating unit of equipment to starting position for new entry.
- Selected the patient record you have created.
- Accessed the main program on touch pad screen to control the equipment.
- Have the imaging capture software on PC.

5.1.1 Preparing the unit and setting the acquisition parameters

From the touch pad panel, do the following procedures to prepare the parameters for a specific patient and mode.

1. From the main screen of the LCD, touch the **Standard** button to have the next screen.

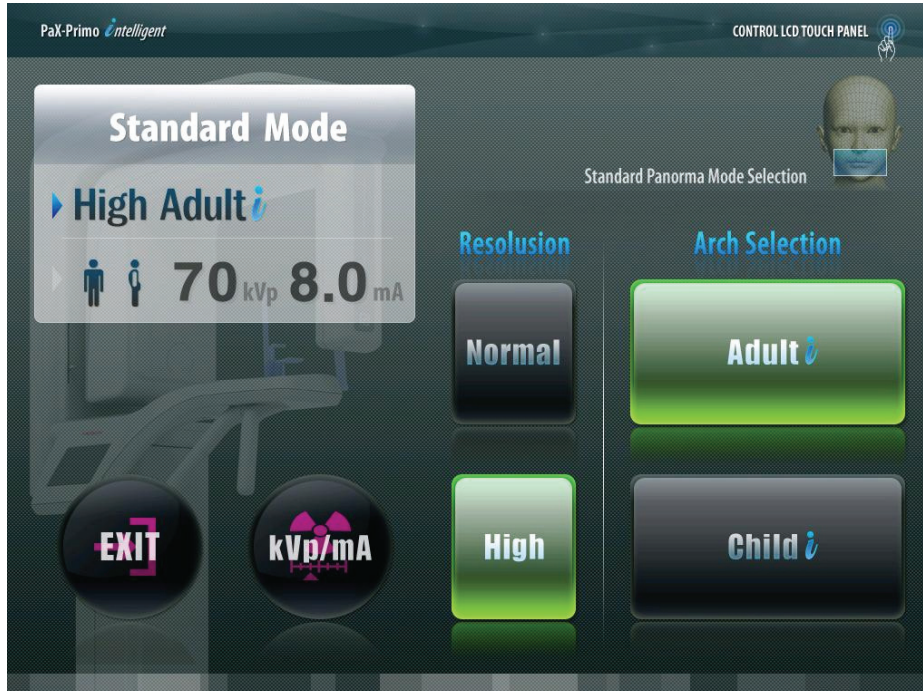

2. Select the resolution with which image is to be taken, Normal or High.
3. Select the patient type.



- Adjust “kVp/mA” finely, if necessary using Up/Down arrows.

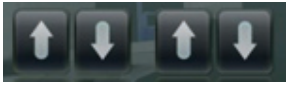

Left: kVp Right: mA

- Touch the **EXIT** button to return to the main screen.



It is necessary to adjust exposure parameters manually to reflect the patient's unique features like structure of bone and its density. This is done through kVp/mA adjustment.

Refer to the look-up table for details in APPENDIX.

5.1.2 Preparing and positioning the patient

To prepare and position the patient, do follow the next steps.



Correct posture is very important factor for the best image possible. This is because it reduces the shadow of spinal column transferred to the reconstructed image.

- Have the patient remove all jewelry and metallic objects, such as earrings, hair pins, spectacles, dentures, and orthodontic appliances. These items can cause shadow images that may obscure diagnosis.

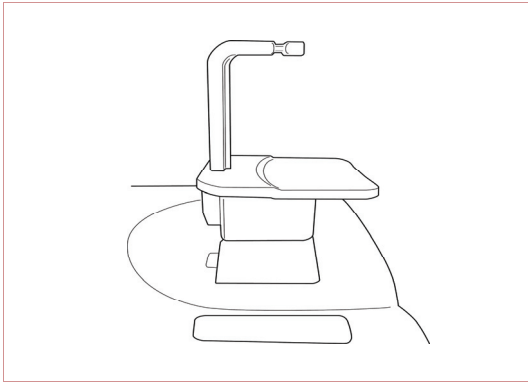

2. Insert the normal chin support and bite block in the unit's chinrest receptacle. Place a hygienic cover over the bite block.

3. It is recommended that the patient wear a lead apron for protection against any possible scatter radiation.

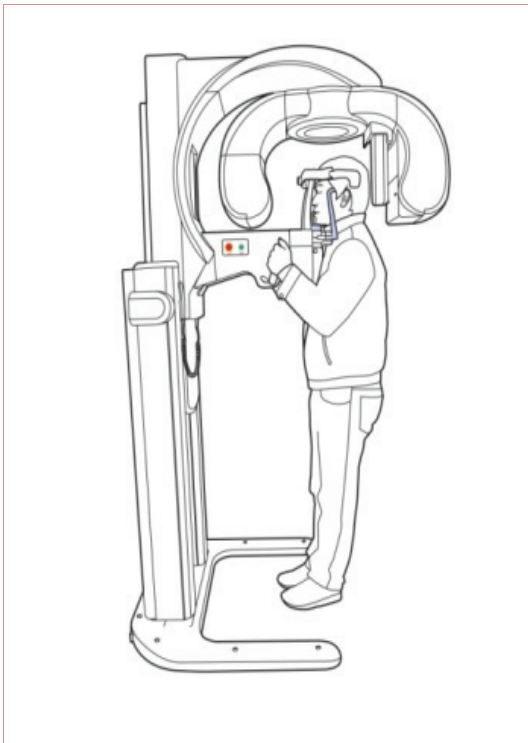

4. Have the patient stand upright at the center of the machine with their chin in line with the chinrest. Ask the patient to grip both handles on either side of the unit firmly.

Ask the patient to position the feet slightly forward.



NOTE

Although the figure itself on the above is different from the PaX-Primo, the patient's positioning is the exactly the same

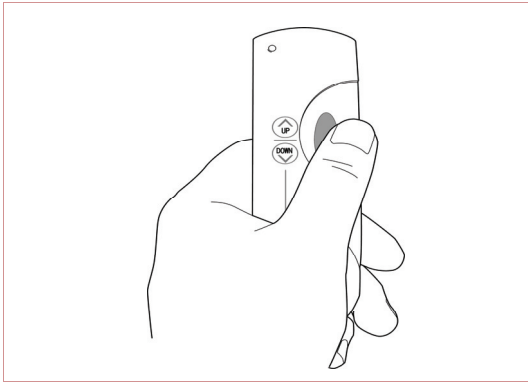

- Adjust the height of the system using the column up/down switch until the patient's chin is resting on the chinrest. Position the patient's chin on the normal chin support.

- The mid-sagittal positioning laser beam for the vertical alignment and the horizontal positioning laser beam for a Frankfurt plane alignment are activated by touching **Position** button on the main screen.
- Ensure that the patient's shoulders remain level and their neck is relaxed. The cervical spine should be straight and upright. To prevent magnifications on the left and right sides of the final image, make sure that the vertical laser beam is positioned at the center of the occipital bone.

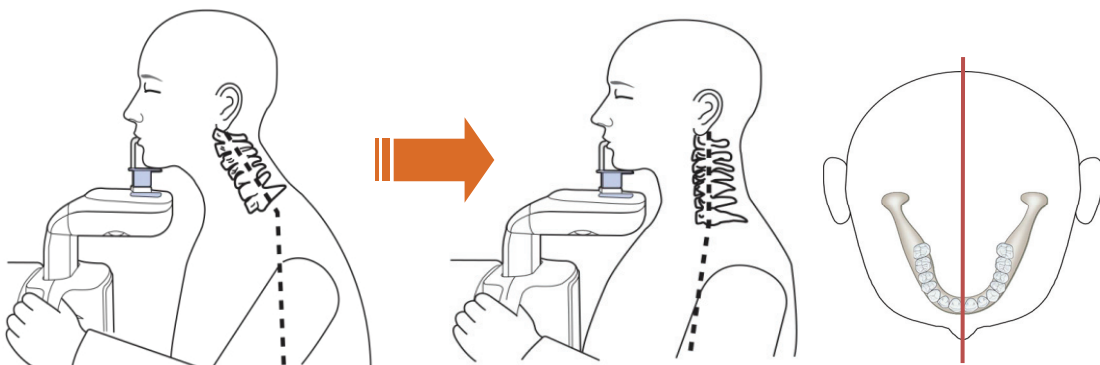

- Have the patient bite the bite block along the grooves using their upper and lower incisors. Ensure that the chin is in good contact with the chin support.

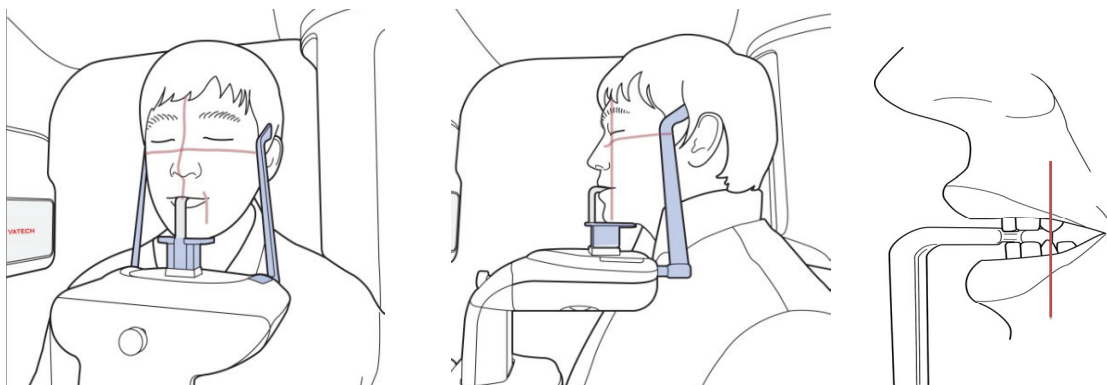

9. Have the patient smile to properly position the canine laser beam at the center of the patient's canine tooth. Rotate the thumb wheel, located under the patient support rest, forward and backward to properly align the beam.

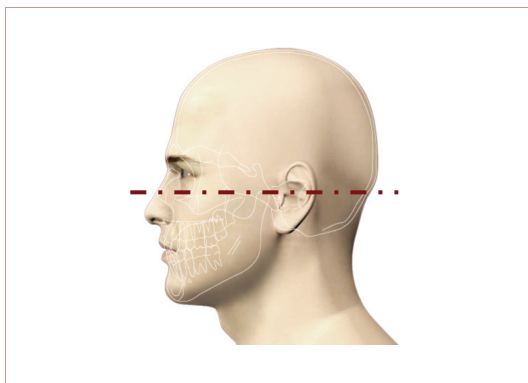
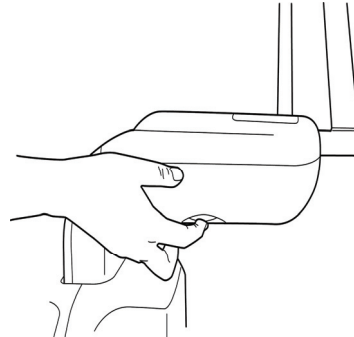
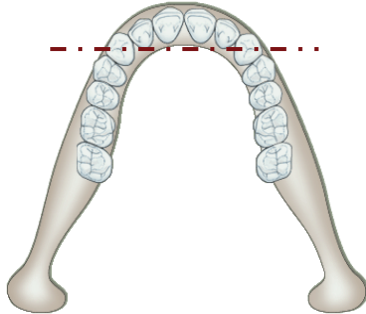

10. Position the head of the patient to properly align their Frankfort plane with the horizontal laser beam. For proper positioning, adjust in which way the patient's head is tilted by adjusting the unit slightly upward or downward using the column up/down switch. The Frankfort plane is the line from the

infra-orbital point to the superior edge of the External Auditory Meatus(EAM).

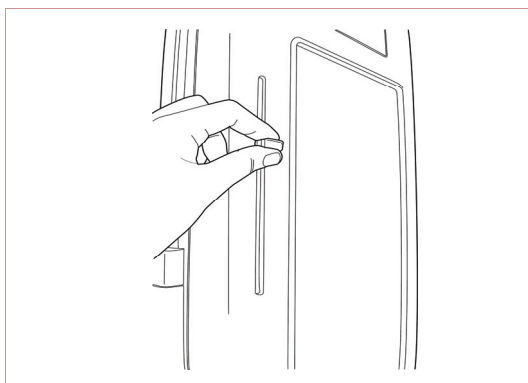

11. The horizontal laser beam, located at the side of the column, can be adjusted up or down to accommodate different head sizes. This is done by manually moving the horizontal laser beam lever up or down.



12. Using the temple support wheel button, adjust the temple supports to fit snugly on either side of the patient's head. The patient's head should be immobilized. The temple support wheel button is located at the front of the patient support rest.

13. Have the patient close their lips and keep their tongue positioned towards the palate throughout the exposure cycle.
14. For a patient with no teeth, the vertical laser beam should be positioned on the patient's mid-sagittal line. The horizontal laser beam should be aligned along the Frankfort plane. Align the canine beam on the fold on the side of the nose.

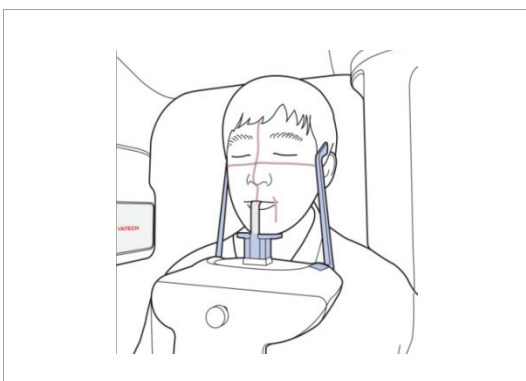
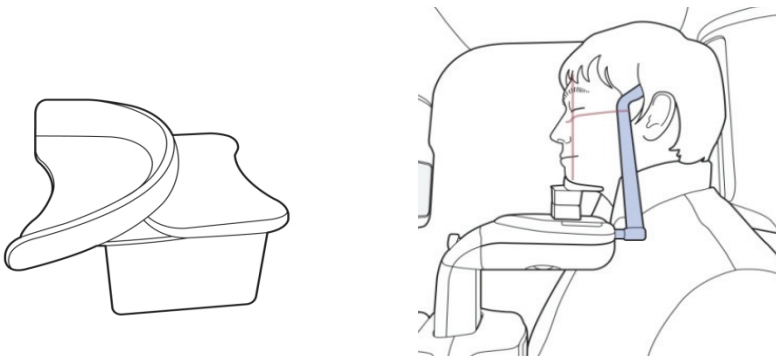

15. Ensure that the patient's eyes are closed. Ask the patient to remain still, swallow and place the tongue in contact with the palate and to breathe through the nose.

16. Please make sure that the patient's positioning is complete and final.

5.1.3 Preparing for launch of X-Ray

1. Click 

There are two cases of environment, depending on availability of the storage devices at the image-taking moment.

- **USB or network connection not found**

The following message will be displayed



You are given two choices. If Okayed it will proceed in a normal imaging steps
If canceled, it returns to the initial state.

- **At least one is available**

The following screen will appear

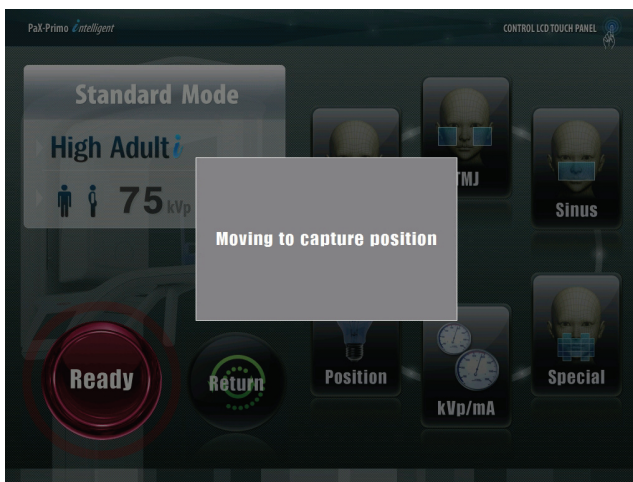

In summary the following flow chart explains the inter-working relationship between modules from the “confirm” to “Ready” state.



Flow of procedure

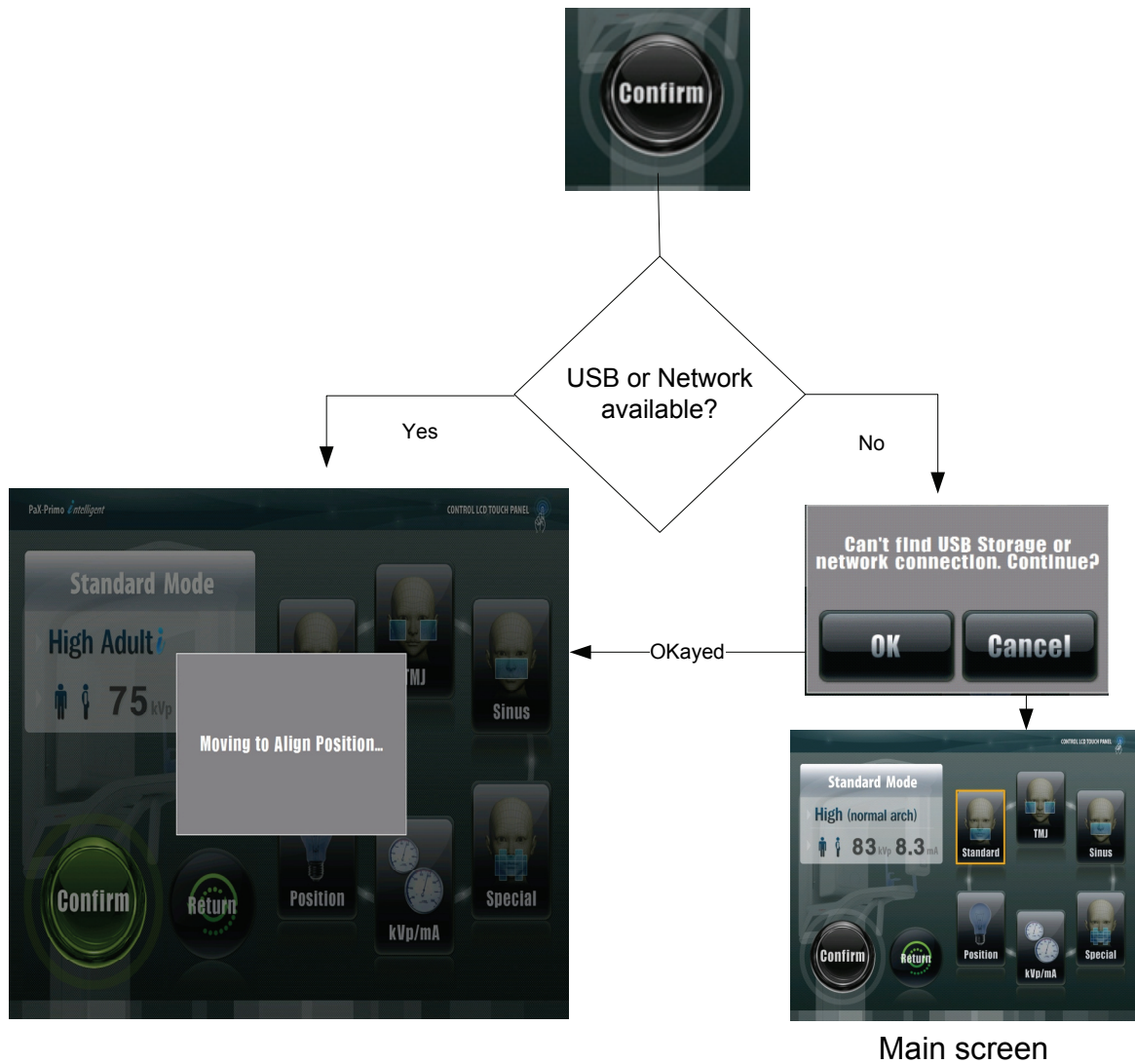

2. After completion of movement, the **“Ready”** button will turn red and blink. Click **“Ready”** button. Then the rotating unit will put in proper position to be ready to take image, with the message on display.

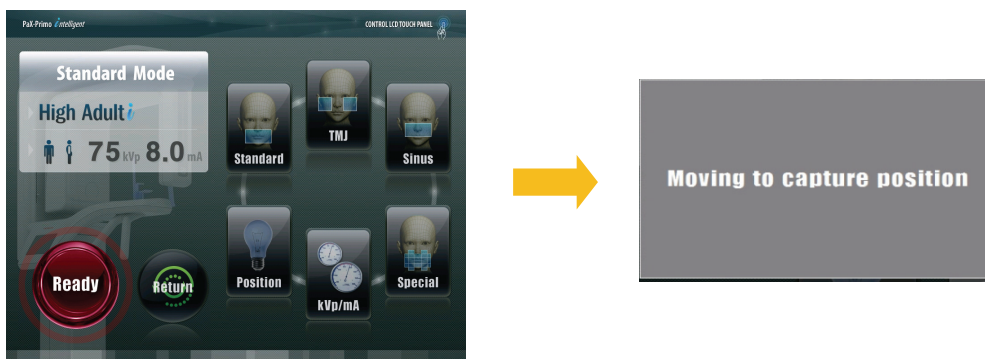

3. Then after all the initialization processing inside the LCD modules completed, the LCD returns to the main screen and announcement that *capturing image is ready* is heard.



USB itself is not provided with the PaX-Primo i. Thus it is recommended that the USB with following specification be mandatory to use.

Type : USB Flash Drive

Write Specification : USB 2.0

5.1.4 Launching the exposure

To launch the X-ray emission, do the following steps.

1. Leave the X-Ray room and close the door. From outside of the x-ray room, you must consistently monitor and pay attention to the patient during acquisition.



In cases of any problems, release the exposure switch button or press the red emergency stop button on the column. (See the following figure)

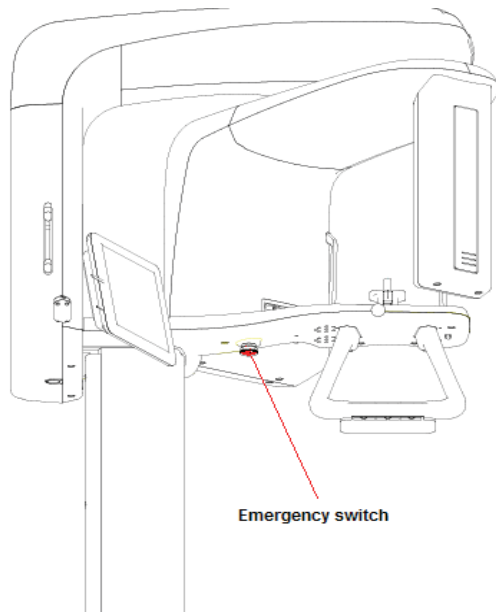

2. Launch X-ray using the exposure switch. Press and hold it until the end of acquisition. Observe the LED lamp on top of the system, as it should turn orange, indicating X-ray emission.



3. You see the message “Acquiring image”.



If the bridge software is installed and the Ethernet network is connected, the progressive bar and the same message can be seen (displayed) on the PC (desktop)



4. Upon completing the acquisition, the LCD module will start to preprocess the panoramic image and display the resulted image on the preview window. You are asked if the image is saved or cancelled. The following will explain the flow of logic.

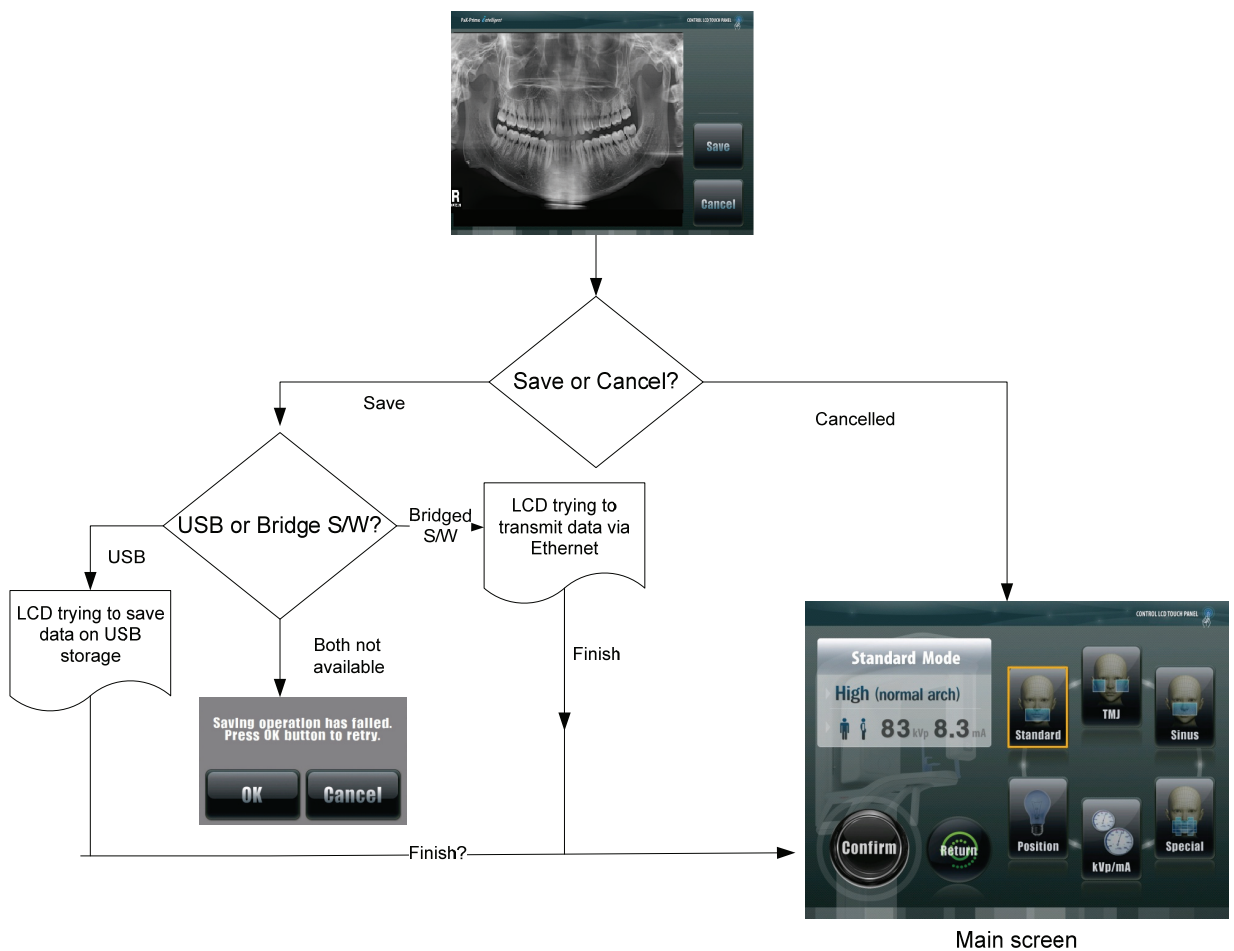

5.1.5 Post-processing on the PC

1. After post-processing, the capture program running on the PC will display image delivered either by the USB or by the Ethernet.

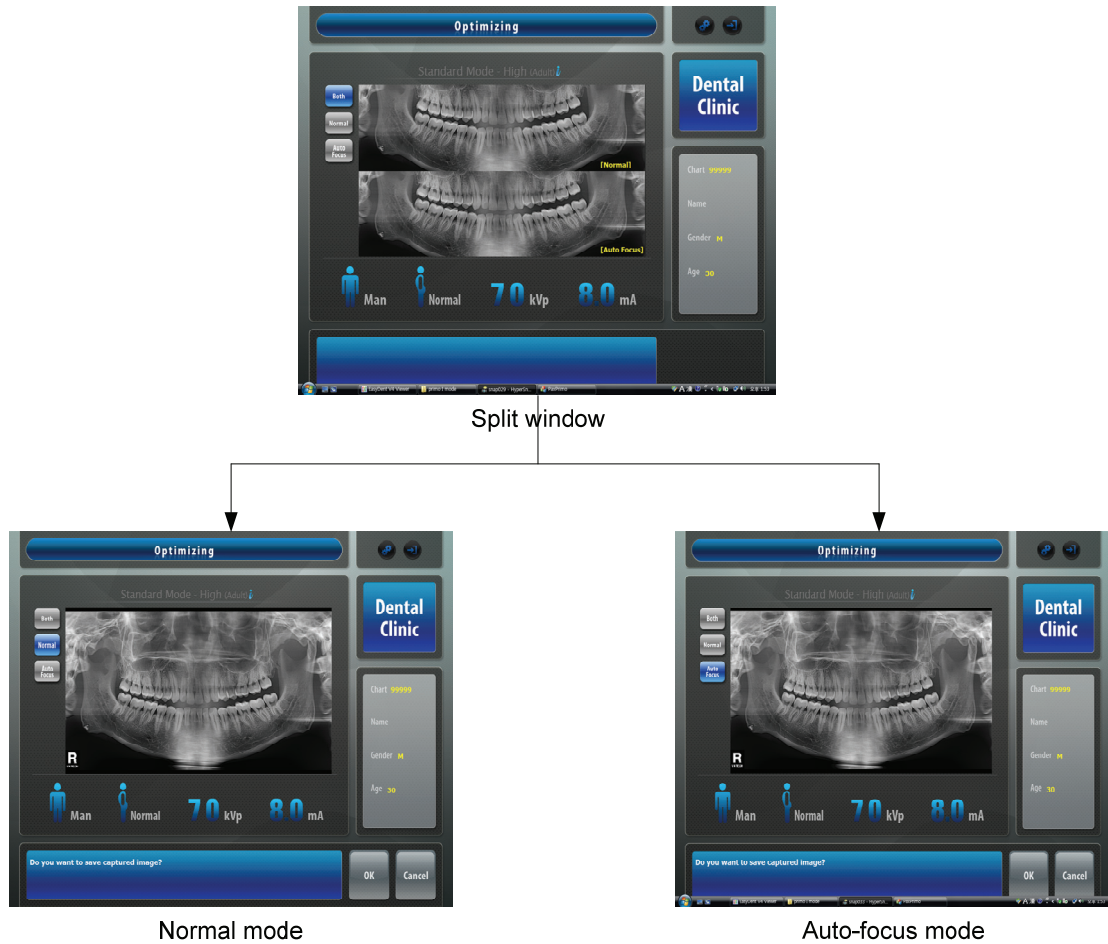

2. You are asked to save image in either Normal or Autofocus mode.
 Save it to your choice by clicking **“OK”**
 When the acquisition is finished, the acquired image is automatically transferred to the **EasyDent** program.

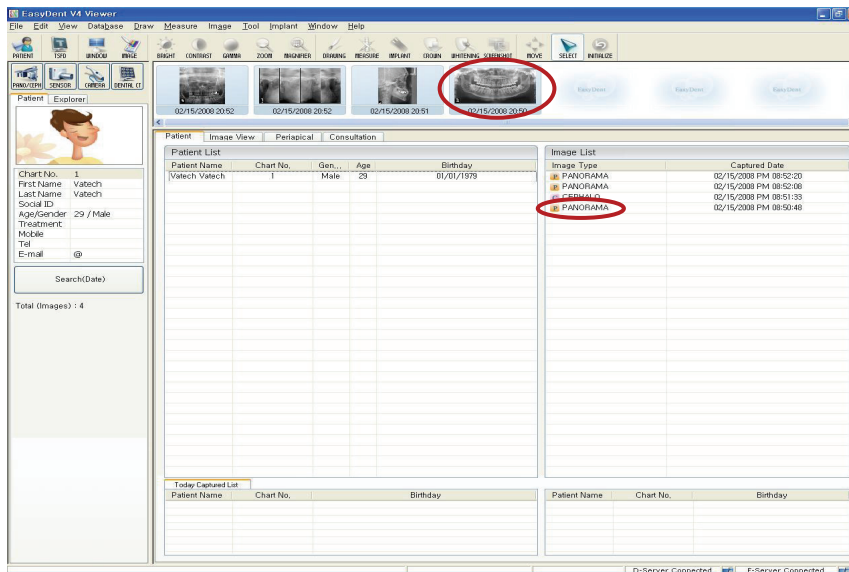

When you click the name of the patient on the patient list of EasyDent, the image list will be reconfigured. A recently captured image appears on the thumbnail images, as shown in the figure. Double click the image to check it in detail.

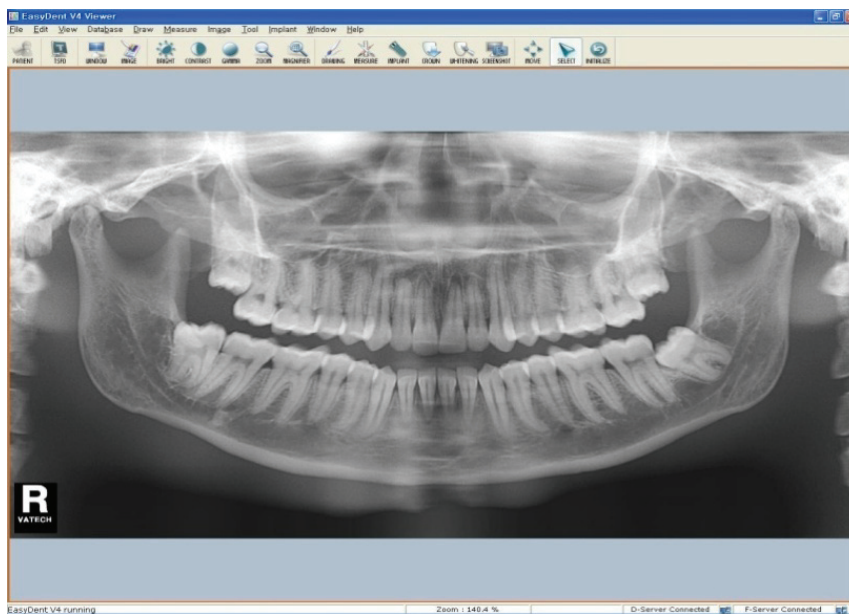

3. Check the image quality.
4. Do the following when the acquisition is finished.
 - Loosen the temple supports and release the patient.
 - Remove the hygiene barrier of the bite block.
 - Reset the rotating unit for the next acquisition.

5.2 Acquiring *TMJ*(Temporomandibular Joint)image

Before acquiring image, make sure that you have:

- Reset a rotating unit of equipment to starting position for new entry.
- Selected the patient record you have created.
- Accessed the main program on touch pad screen to control the equipment.
- Have the imaging capture software on PC.

5.2.1 Preparing the unit and setting the acquisition parameters

From the touch pad panel, do the following procedures to prepare the parameters for a specific patient and mode.

1. Select the **TMJ** mode in yellow box from the main screen.
Then the next will appear.

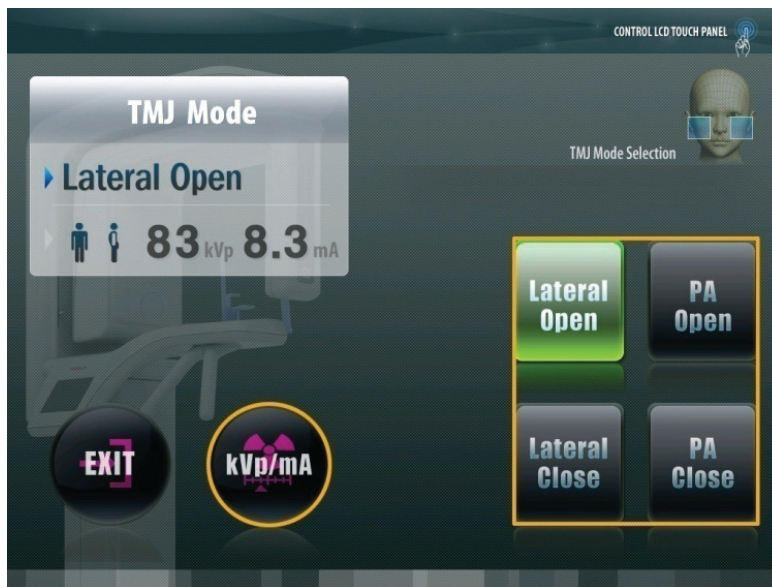

2. Select the mode to be taken from 4 different types.
3. Adjust “**kVp/mA**” finely, if necessary, by adjusting the following arrows

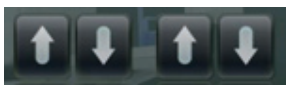

4. Touch the **EXIT** to return to main screen when all is set.



From there, upon clicking **Confirm** button, it will transform into **Ready** button.



NOTE

It is necessary to adjust exposure parameters manually to reflect the patient's unique features like structure of bone and its density. This is done through kVp/mA adjustment.

Refer to the look-up table for details in APPENDIX.

5.2.2 Preparing and positioning the patient

To prepare and position the patient, follow the next steps.



IMPORTANT

Correct posture is very important factor for the best image possible.

This is because it reduces the shadow of spinal column transferred to the reconstructed image.

1. Have the patient remove all jewelry and metallic objects, such as earrings, hair pins, spectacles, dentures, and orthodontic appliances. These items can cause shadow images that may obscure diagnosis.

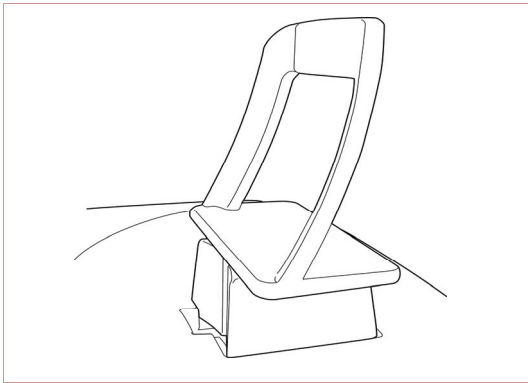

2. Insert the chin support (TMJ).

3. It is recommended that the patient wear a lead apron for protection against any possible scatter radiation.

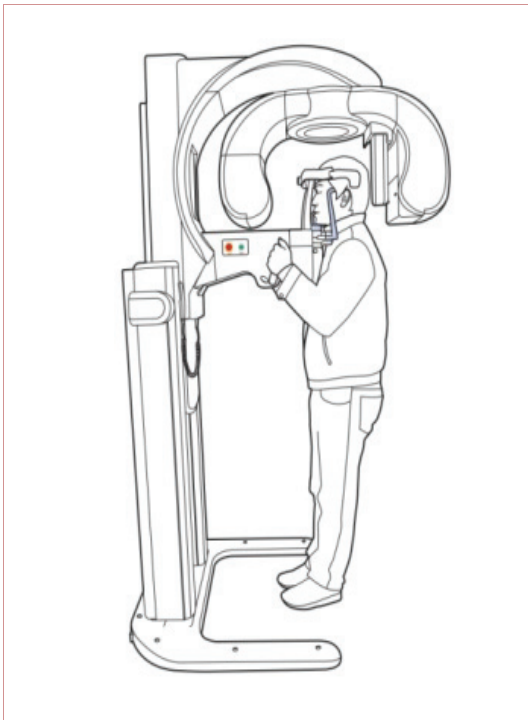

4. Have the patient stand upright at the center of the machine with their chin in line with the chinrest. Ask the patient to grip both handles on either side of the unit firmly.

Ask the patient to position feet slightly forward.



Although the figure itself on the above is different from the PaX-Primo, the patient's positioning is the exactly the same



- Adjust the height of the system using the column up/down switch until the patient's chin is resting on the chin rest. The top of the TMJ support should be in contact with the patient's acanthion point.

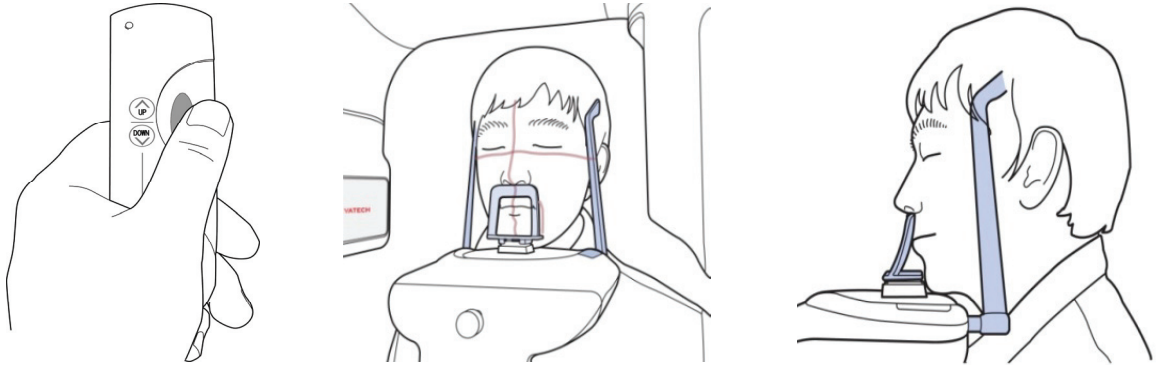

- Ensure that the patient's shoulders remain level and their neck is relaxed. The cervical spine should be straight and upright. To prevent magnifications on the left and right sides of the final image, make sure that the vertical laser beam is positioned at the center of the occipital bone.

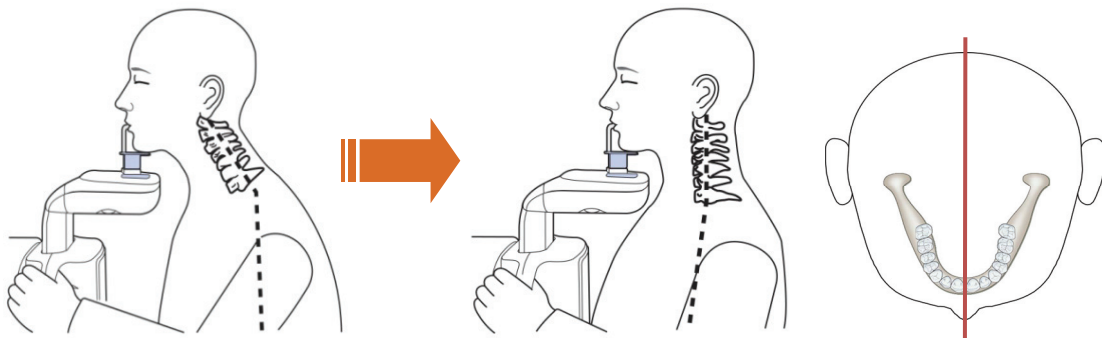

- Position the head of the patient to properly align their Frankfort plane with the horizontal laser beam. For proper positioning, adjust in which way the patient's head is tilted by adjust the unit slightly upward or downward using the column up/down switch. The Frankfort plane is the line from the infra-orbital point to the superior edge of the External Auditory Meatus(EAM).

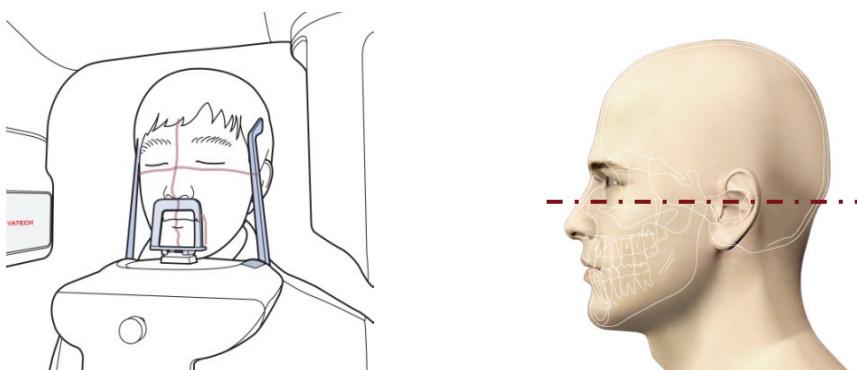

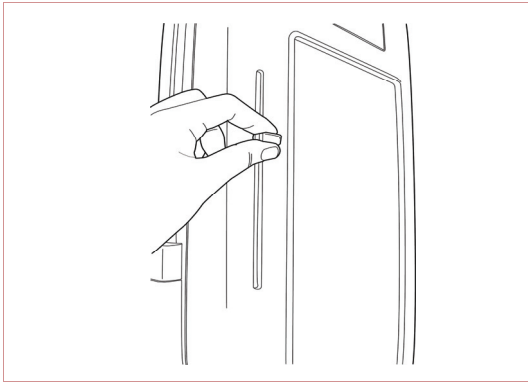

8. The horizontal laser beam, located at the side of the column, can be adjusted up or down to accommodate different head sizes. This is done by manually moving the horizontal laser beam lever up or down.

9. Have the patient smile to properly position the canine laser beam at the center of the patient's canine tooth. Rotate the thumb wheel, located under the patient support rest, forward and backward to properly align the beam.

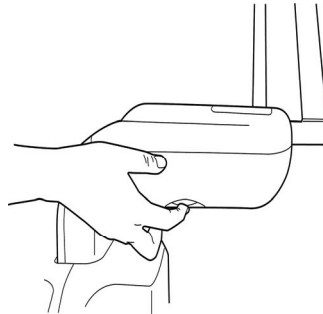
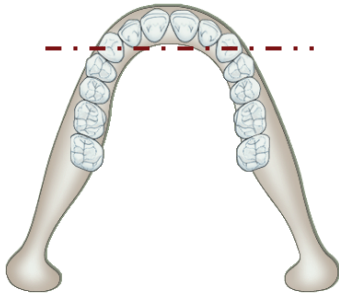

10. For TMJ – Open imaging, the patient's mouth should be opened as wide as possible. The top of the TMJ support and the patient's acanthion point must remain in contact.

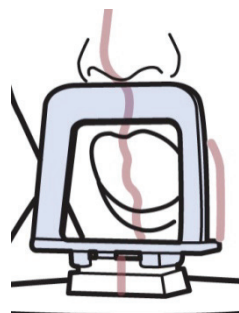
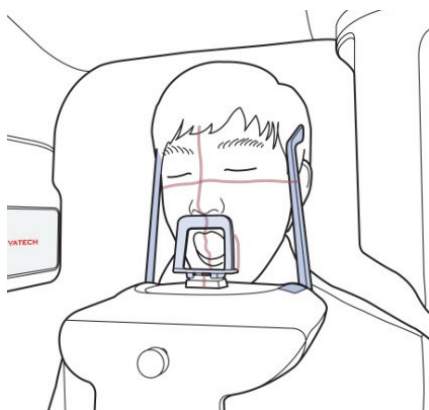

11. Have the patient close their eyes and rest their tongue at the bottom of their mouth throughout the exposure cycle.



12. Using the temple support wheel button, adjust the temple supports to fit snugly on either side of the patient's head. The patient's head should be immobilized. The temple support wheel button is located at the front of the patient support rest.

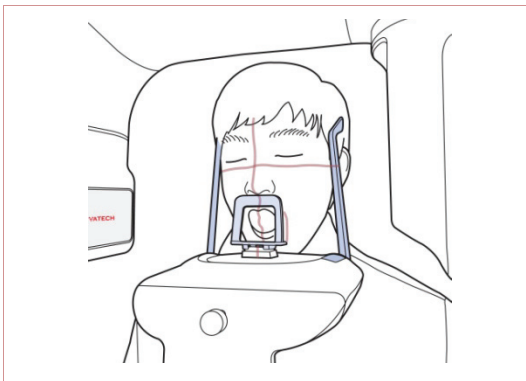

13. Ensure that the patient does not move during image acquisition. To expose, press and hold the exposure switch until TMJ – Open image acquisition is completed.



14. To subsequently take the TMJ–Closed image, the patient's mouth will now remain closed. The upper lip must make contact with the TMJ support.

15. Have the patient smile to properly position the canine laser beam at the center of the patient's canine tooth. Rotate the thumb wheel, located under the patient support rest, forward and backward to properly align the beam.

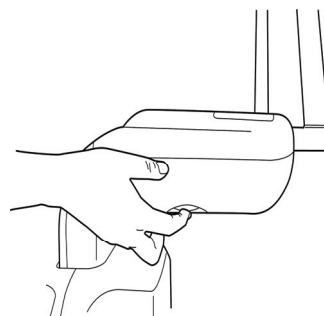
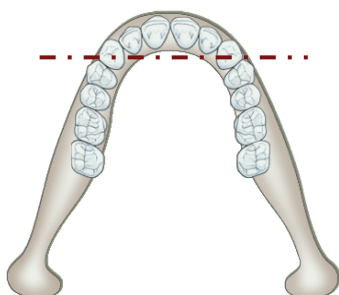

16. Have the patients close their lips and rest their tongue at the bottom of their mouth throughout the exposure cycle.



17. Position the head of the patient to properly align their Frankfort plane with the horizontal laser beam. For proper positioning, adjust in which way the patient's head is tilted by adjust the unit slightly upward or downward using the column up/down switch. The Frankfort plane is the line from the

infra-orbital point to the superior edge of the External Auditory Meatus (EAM).

18. Ensure that the patient's eyes are closed. Ask the patient to remain still, swallow and place the tongue in contact with the palate and to breathe through the nose.
19. Make sure that adjusting the patient positioning is complete

5.2.3 Preparing for launch of X-Ray

Go to the clause '5.1.3 preparing for launch of X-Ray' to follow the same procedures.

5.2.4 Launching the exposure

Go to the subchapter 5.1.5 for these procedures



5.2.5 Post-processing image on the PC

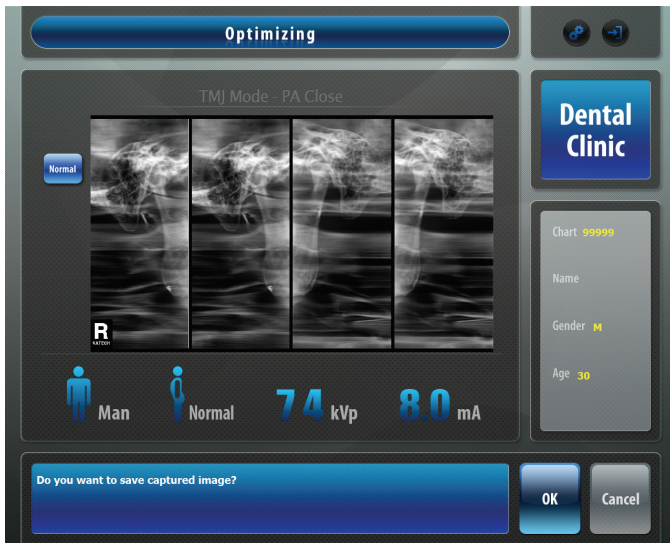

Click "OK" button to save current image.



TMJ mode does not support the auto-focusing features

When the acquisition is finished, the acquired image is automatically transferred to the **EasyDent** program.

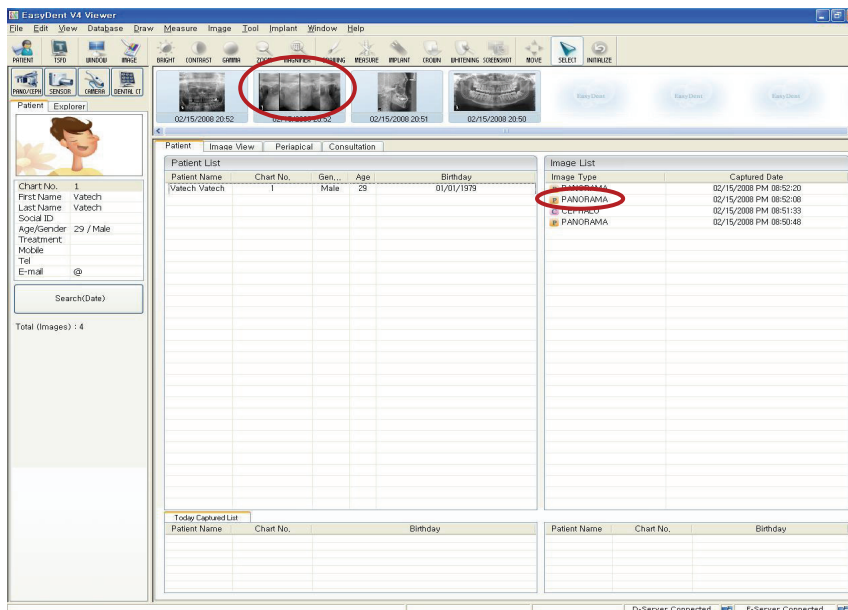

When you click the name of the patient on the patient list of EasyDent, the image list will be reconfigured. A recently captured image appears on the thumbnail images, as shown in the figure. Double click the image to check it in detail.

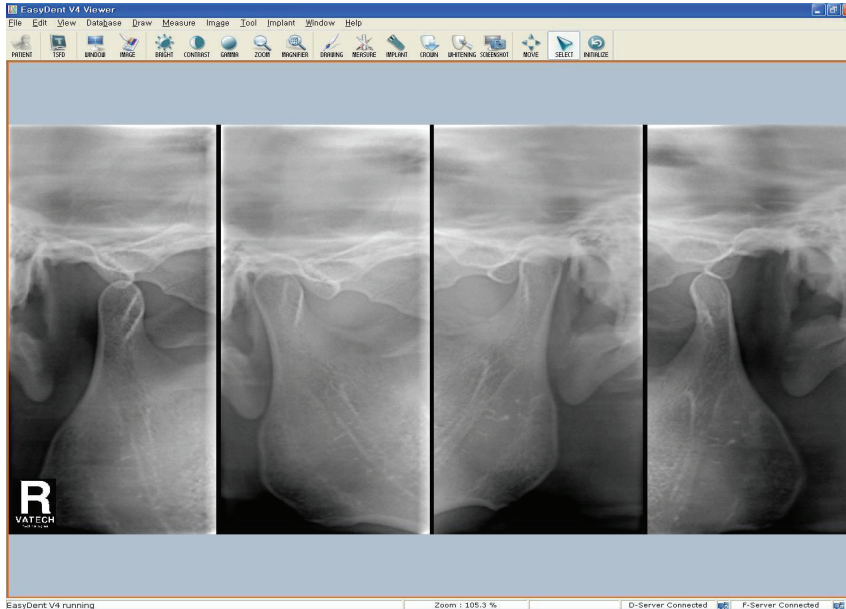

1. Check the image quality.
2. Do the following when the acquisition is finished.
 - Loosen the temple supports and release the patient.
 - Remove the hygiene barrier of the bite block.
 - Reset the rotating unit for the next acquisition.



5.3 Acquiring *Sinus* image

Before acquiring image, make sure that you have:

- Reset a rotating unit of equipment to starting position for new entry.
- Selected the patient record you have created.
- Accessed the main program on touch pad screen to control the equipment.
- Have the imaging capture software on PC.

5.3.1 Preparing the unit and setting the acquisition parameters

From the touch pad panel, do the following procedures to prepare the parameters for a specific patient and mode

1. Select the **Sinus** mode from the main screen.

The following figure will come up.

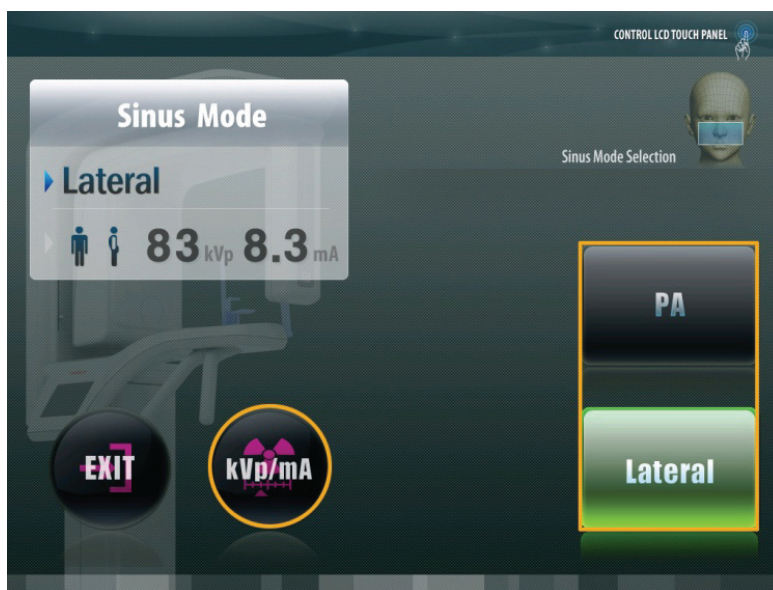

There are only two sub-modes, the PA and Lateral

2. Select your choice of taking image from the PA and Lateral.
3. If necessary, do fine adjustment using **kVp/mA**.
4. On completing procedures, touch the **EXIT** button to return to main screen.



It is necessary to adjust exposure parameters manually to reflect the patient's unique features like structure of bone and its density. This is done through kVp/mA adjustment.

Refer to the look-up table for details in APPENDIX.

5.3.2 Preparing and positioning the patient

To prepare and position the patient, follow the next steps.



Correct posture is very important factor for the best image possible. This is because it reduces the shadow of spinal column transferred to the reconstructed image.

1. Have the patient remove all jewelry and metallic objects, such as earrings, hair pins, spectacles, dentures, and orthodontic appliances. These items can cause shadow images that may obscure diagnosis.

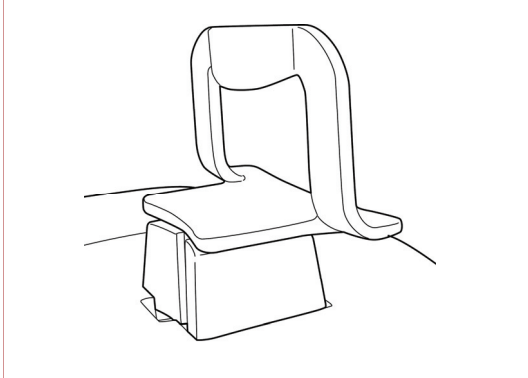

2. Insert the Chin support (Sinus).

3. It is recommended that the patient wear a lead apron for protection against any possible scatter radiation.

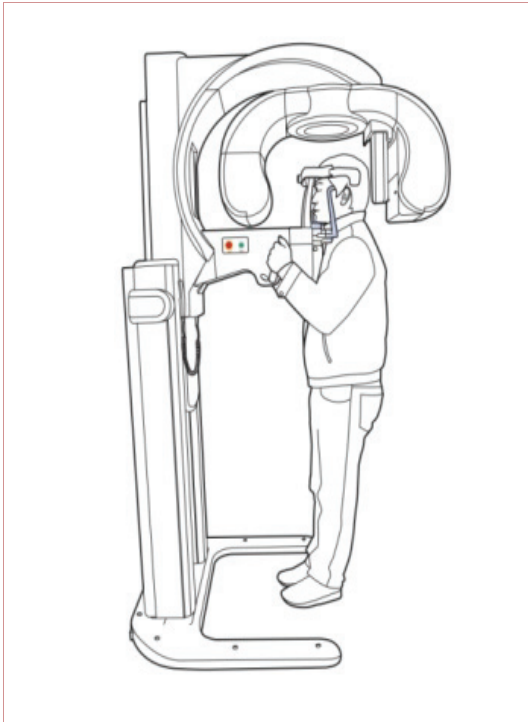

4. Have the patient stand upright at the center of the machine with their chin in line with the chinrest. Ask the patient to grip both handles on either side of the unit firmly.

Ask the patient to position feet slightly forward.



Although the figure itself on the above is different from the PaX-Primo, the patient's positioning is the exactly the same

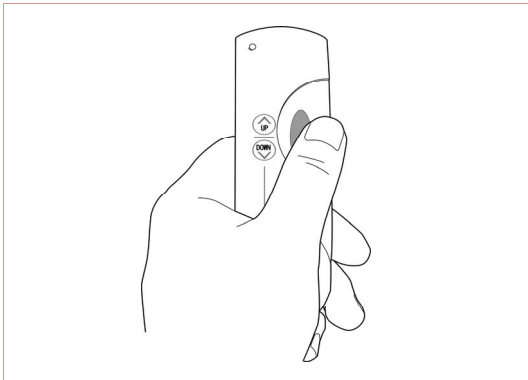

5. Adjust the height of the system using the column up/down switch until the patient's chin is resting on the sinus chin support.

6. Ensure that the patient's shoulders remain level and their neck is relaxed. The cervical spine should be straight and upright. To prevent magnifications on the left and right sides of the final image, make sure that the vertical laser beam is positioned at the center of the occipital bone.

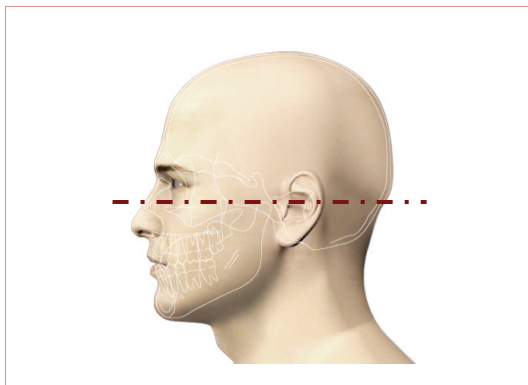
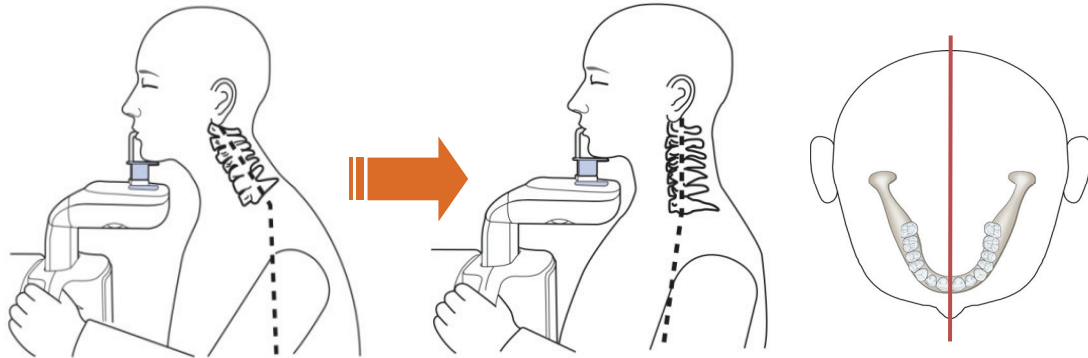

7. Position the head of the patient to properly align their Frankfort plane with the horizontal laser beam. For proper positioning, adjust in which way the patient's head is tilted by adjust the unit slightly upward or downward using the column up/down switch. The Frankfort plane is the line from the

infra-orbital point to the superior edge of the External Auditory Meatus(EAM).

8. The horizontal light should fall on the tip of patient's nose. Therefore, you have to tilt the patient's head 10~15 degrees upward.

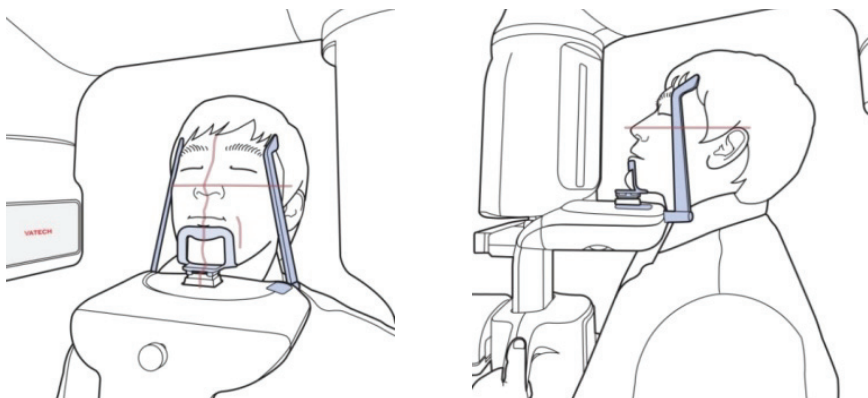



9. Have the patient smile to properly position the canine laser beam at the center of the patient's premolars tooth. Rotate the thumb wheel, located under the patient support rest, forward and backward to properly align the beam.

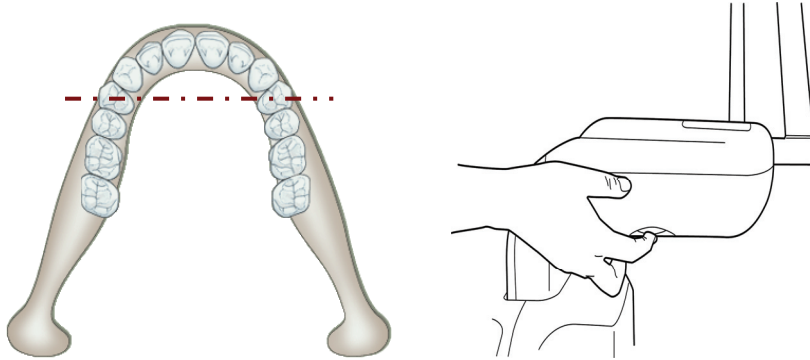

10. Have the patient smile to properly position the canine laser beam at the center of the patient's premolars tooth. Rotate the thumb wheel, located under the patient support rest, forward and backward to properly align the beam.

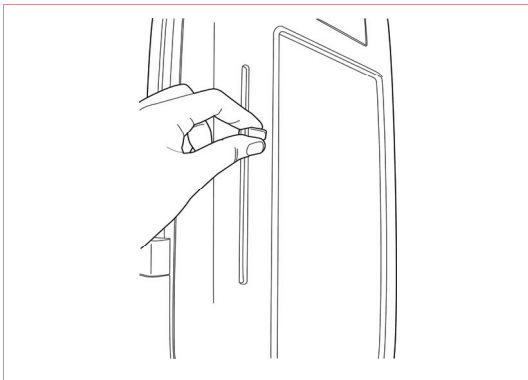

11. Adjust the horizontal laser beam along the patient's Inferior Orbital Fissure. The horizontal laser beam, located at the side of the column, can be adjusted up or down to accommodate different head sizes. This is done by manually moving the horizontal laser beam lever up or down.



12. Using the temple support wheel button, adjust the temple supports to fit snugly on either side of the patient's head. The patient's head should be immobilized. The temple support wheel button is located at the front of the patient support rest.

13. Have the patient close their lips and keep their tongue positioned towards the palate throughout the exposure cycle.



14. Ensure that the patient's eyes are closed. Ask the patient to remain still, swallow and place the tongue in contact with the palate and to breathe through the nose. Press and hold the exposure switch button until image acquisition is complete.



5.3.3 Preparing for launch of X-Ray

Go to the clause '5.1.3 preparing for launch of X-Ray' to follow the same procedures.

5.3.4 Launching the exposure

Go to the subchapter 5.1.5 for these procedures

5.3.5 Post-processing image on the PC

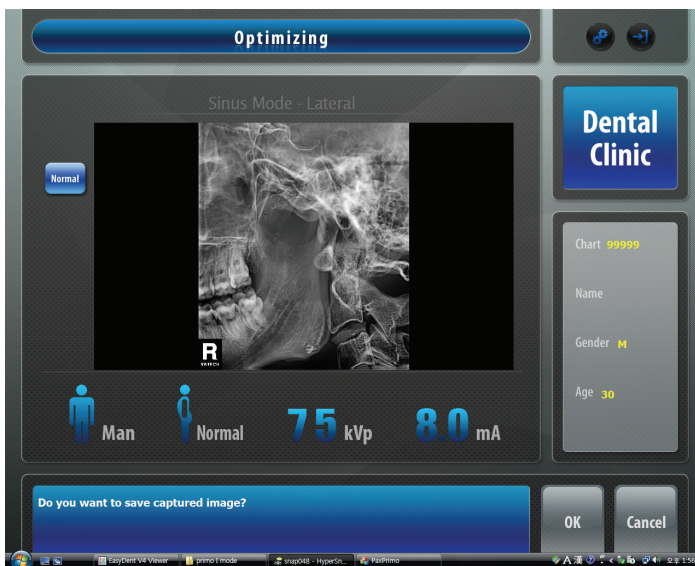

Click “OK” button to save current image



Sinus mode does not support the auto-focusing features.

When the acquisition is finished, the acquired image is automatically transferred to the EasyDent program.

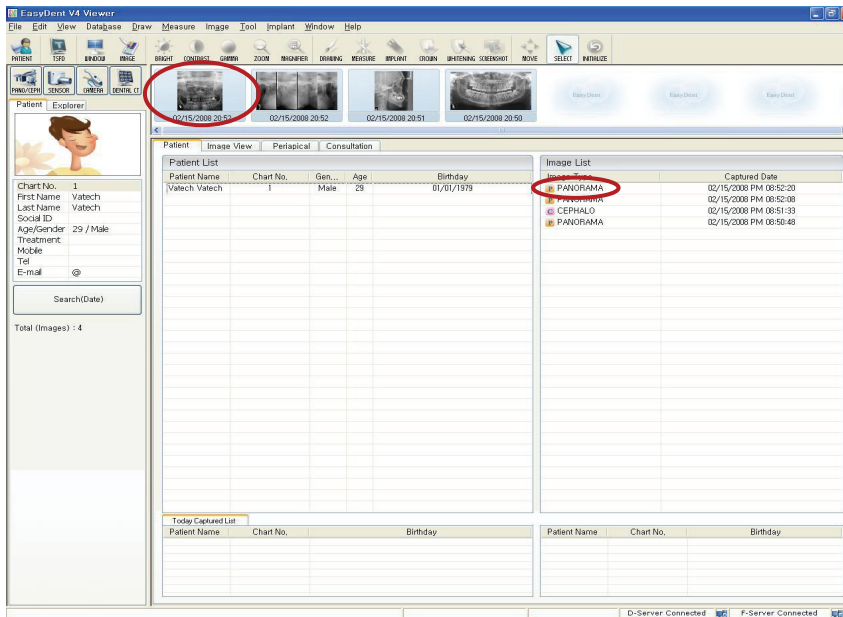

When you click the name of the patient on the patient list of EasyDent, the image list will be reconfigured. A recently captured image appears on the thumbnail images, as shown in the figure. Double click the image to check it in detail.

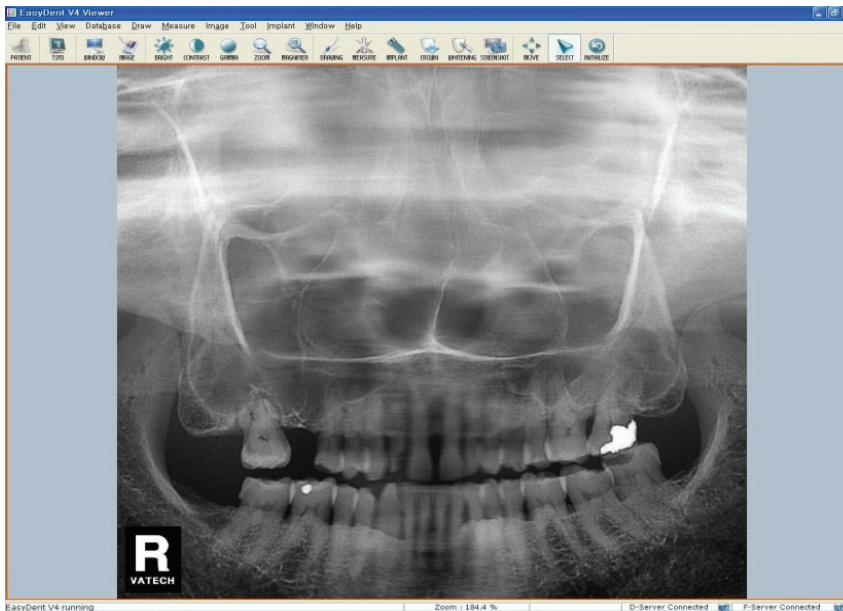

1. Check the image quality.
2. Do the following when the acquisition is finished.
 - Loosen the temple supports and release the patient.
 - Remove the hygiene barrier of the bite block.
 - Reset the rotating unit for the next acquisition.



5.4 Acquiring *Special Panoramic* image

Before acquiring image, make sure that you have:

- Reset a rotating unit of equipment to starting position for new entry.
- Selected the patient record you have created.
- Accessed the main program on touch pad screen to control the equipment.
- Have the imaging capture software on PC.

5.4.1 Preparing the unit and setting the acquisition parameters

From the touch pad panel, do the following procedures to prepare the parameters for a specific patient and mode.

1. Touch **Special** button from main screen.

Then the following figure will appear.



2. Select the mode of your choice from 4 different modes.
3. If necessary, adjust **kVp** and **mA** for the finer tuning different from default.
4. Touch the **EXIT** button to return to the main screen.



NOTE

It is necessary to adjust exposure parameters manually to reflect the patient's unique features like structure of bone and its density. This is done through kVp/mA adjustment.

Refer to the look-up table for details in APPENDIX.

5.4.2 Preparing and positioning the patient

To prepare and position the patient, follow the next steps.



IMPORTANT

Correct posture is very important factor for the best image possible. This is because it reduces the shadow of spinal column transferred to the reconstructed image.

1. Have the patient remove all jewelry and metallic objects, such as earrings, hair pins, spectacles, dentures, and orthodontic appliances. These items can cause shadow images that may obscure diagnosis.

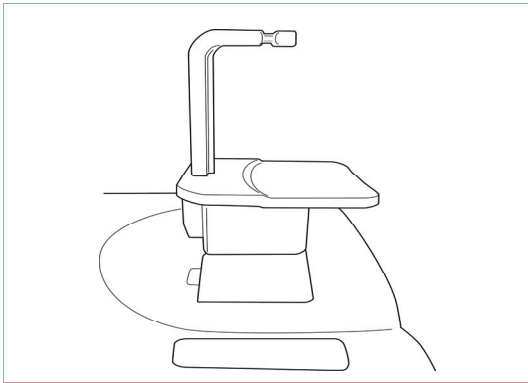

2. Insert the normal chin support and bite block in the unit's chinrest receptacle. Place a hygienic cover over the bite block.

3. It is recommended that the patient wear a lead apron for protection against any possible scatter radiation.

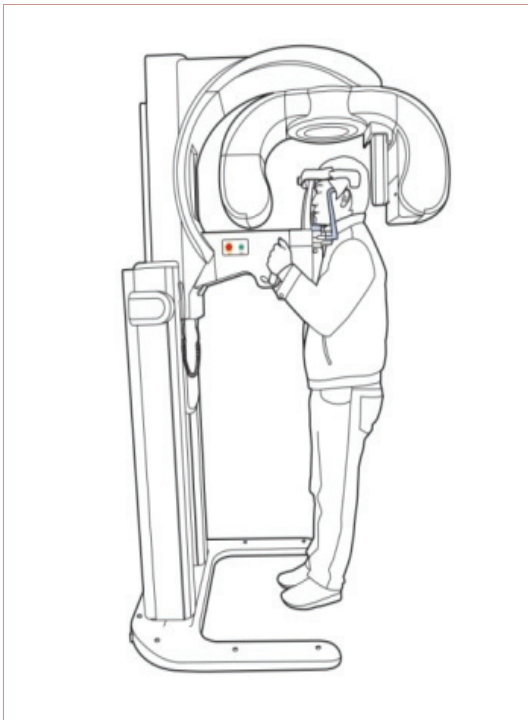

4. Have the patient stand upright at the center of the machine with their chin in line with the chinrest. Ask the patient to grip both handles on either side of the unit firmly.

Ask the patient to position the feet slightly forward.



Although the figure itself on the above is different from the PaX-Primo, the patient's positioning is the exactly the same

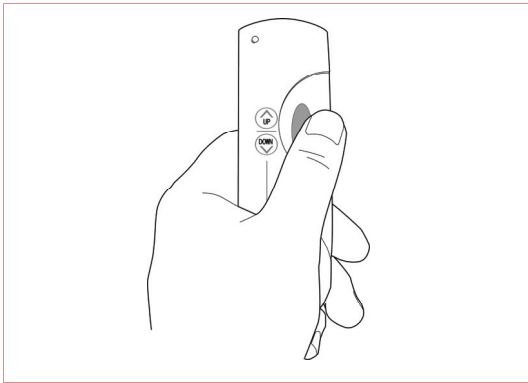

- Adjust the height of the system using the column up/down switch until the patient's chin is resting on the chinrest. Position the patient's chin on the normal chin support.

- The mid-sagittal positioning laser beam for the vertical alignment and the horizontal positioning laser beam for a Frankfurt plane alignment are activated by touching **Position** button on the main screen.
- Ensure that the patient's shoulders remain level and their neck is relaxed. The cervical spine should be straight and upright. To prevent magnifications on the left and right sides of the final image, make sure that the vertical laser beam is positioned at the center of the occipital bone.

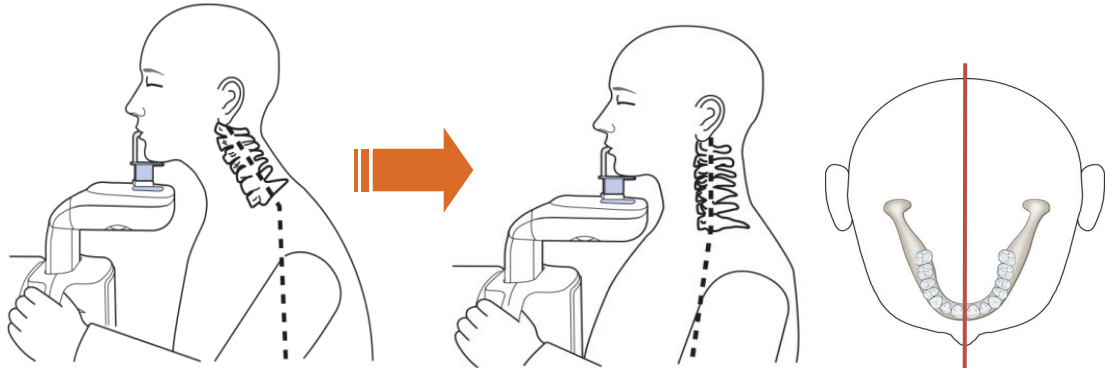



8. The mid-sagittal positioning laser beam for the vertical alignment and the horizontal positioning laser beam for a Frankfurt plane alignment are activated by touching **Position** button on the main screen. Have the patient bite the bite block along the grooves using their upper and lower incisors. Ensure that the chin is in good contact with the chin support.



9. Have the patient smile to properly position the canine laser beam at the center of the patient's canine tooth. Rotate the thumb wheel, located under the patient support rest, forward and backward to properly align the beam.

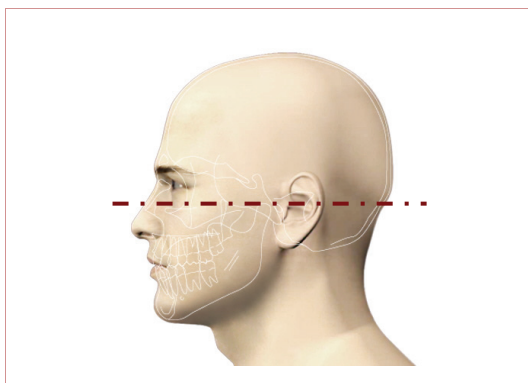
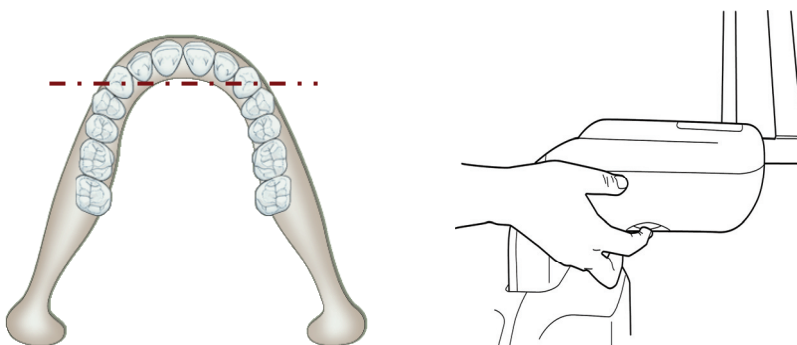

10. Position the head of the patient to properly align their Frankfort plane with the horizontal laser beam. For proper positioning, adjust in which way the patient's head is tilted by adjust the unit slightly upward or downward using the column up/down switch. The Frankfort plane is the line from the infra-orbital point to the superior edge

of the External Auditory Meatus(EAM).

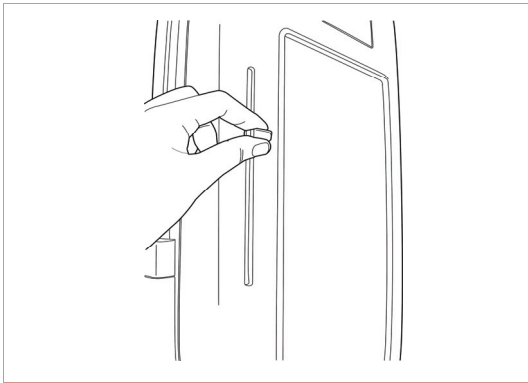

11. The horizontal laser beam, located at the side of the column, can be adjusted up or down to accommodate different head sizes. This is done by manually moving the horizontal laser beam lever up or down.



12. Using the temple support wheel button, adjust the temple supports to fit snugly on either side of the patient's head. The patient's head should be immobilized. The temple support wheel button is located at the front of the patient support rest.

13. Have the patient close their lips and keep their tongue positioned towards the palate throughout the exposure cycle.

14. For a patient with no teeth, the vertical laser beam should be positioned on the patient's mid-sagittal line. The horizontal laser beam should be aligned along the Frankfort plane. Align the canine beam on the fold on the side of the nose.

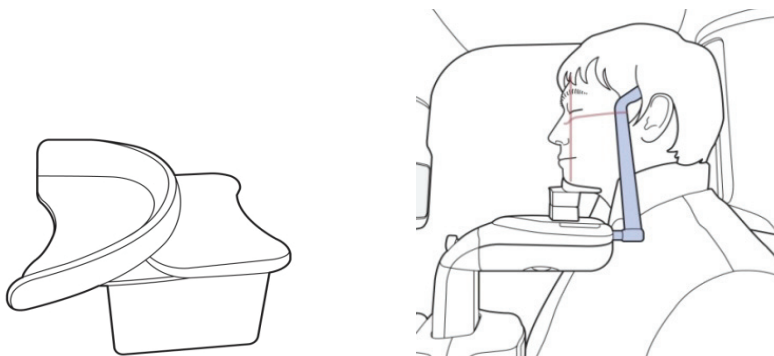

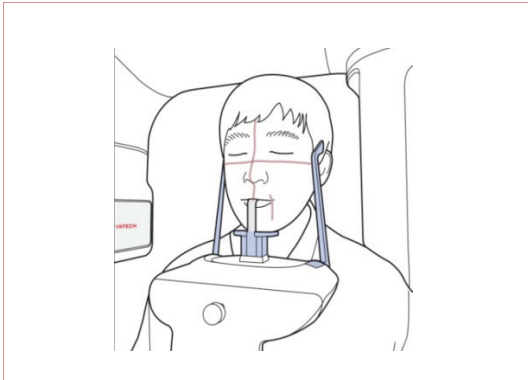

15. Ensure that the patient's eyes are closed. Ask the patient to remain still, swallow and place the tongue in contact with the palate and to breathe through the nose. Press and hold the exposure switch button until image acquisition is complete.

5.4.3 Preparing for launch of X-Ray

Go to the clause '5.1.3 preparing for launch of X-Ray' to follow the same procedures.

5.4.4 Launching the exposure

Go to the subchapter 5.1.5 for these procedures

5.4.5 Post-processing image on the PC

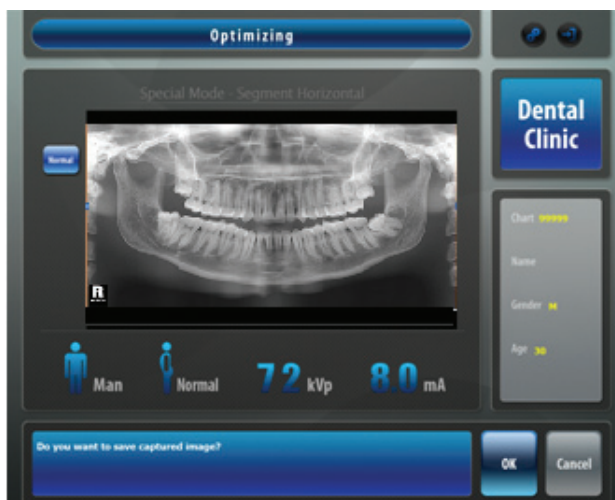

Click "OK" button to save current image.

When the acquisition is finished, the acquired image is automatically transferred to the **EasyDent** program.

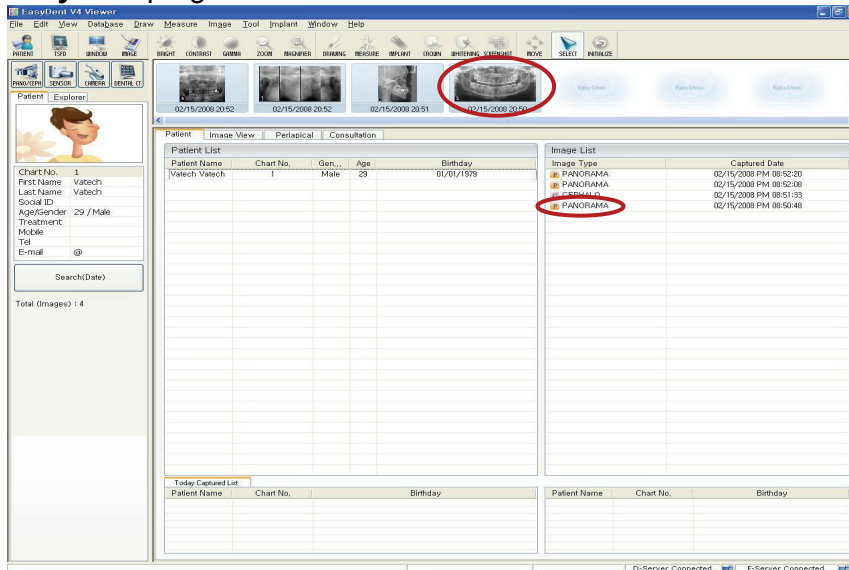

When you click the name of the patient on the patient list of EasyDent, the image list will be reconfigured. A recently captured image appears on the thumbnail images, as shown in the figure. Double click the image to check it in detail.

Resultant Panoramic image can be checked through **EasyDent V4 Viewer**.

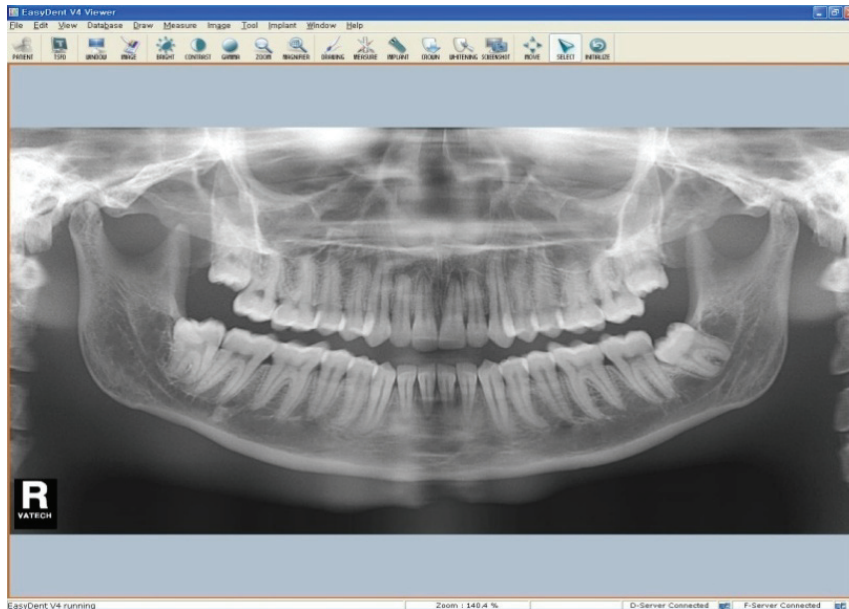

1. Check the image quality.
2. Do the following when the acquisition is finished.
 - Loosen the temple supports and release the patient.
 - Remove the hygiene barrier of the bite block.
 - Reset the rotating unit for the next acquisition.



5.4.6 Sample images of Special mode

<Segment Horizontal>

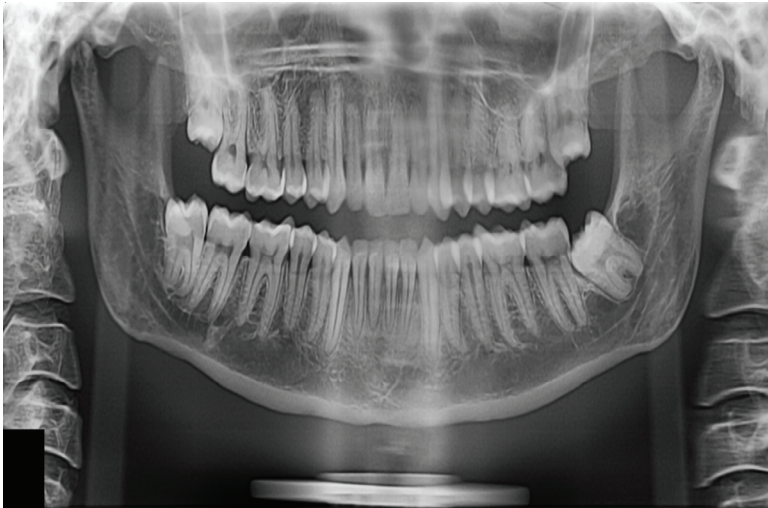

<Segment Vertical>

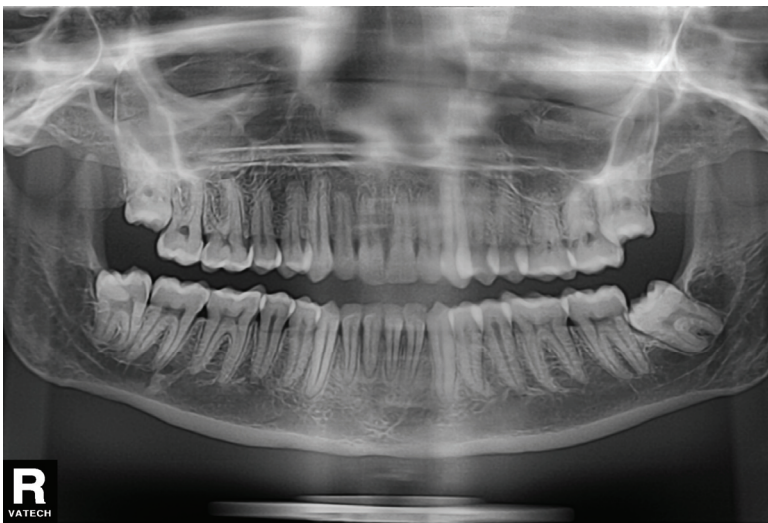

<Bitewing>

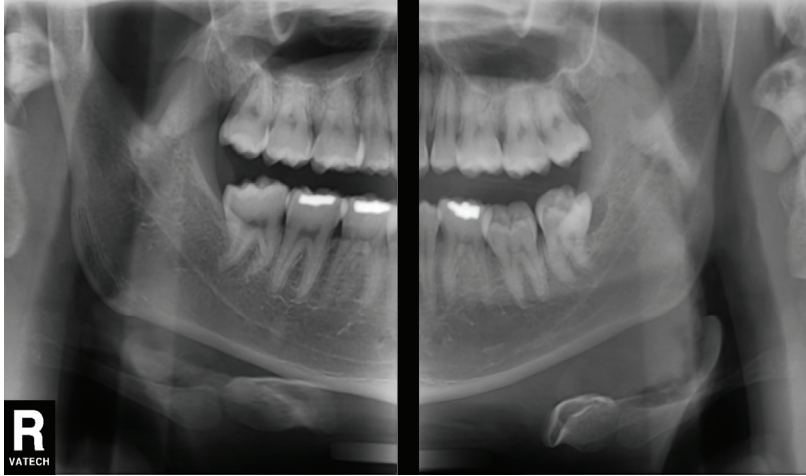

<Orthogonal>

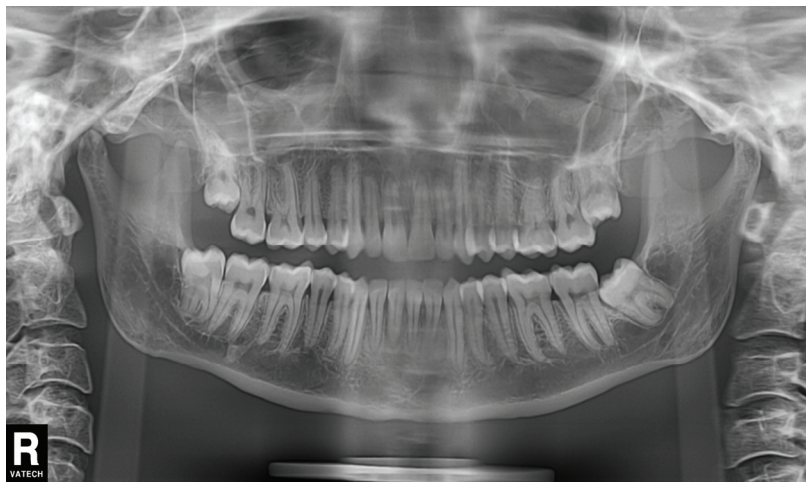



Chapter 6 Upgrading to the imaging system with auto-focusing capability

The **PaX-Primo** can be upgraded, as needed basis, to the **PaX-Primo *i*** that incorporates the capability of auto-focusing the objects (patients), thus leading to the acquisition of much improved image *free from the patient's faulty position and arch shape*.

This is made possible by the VATECH's proprietary AUTO FOCUSING (Adaptive layer mode panoramic tomography) algorithm.

The detailed explanation will follow in the next section.

6.1 The imaging modes with the AUTO FOCUSING implementation supported

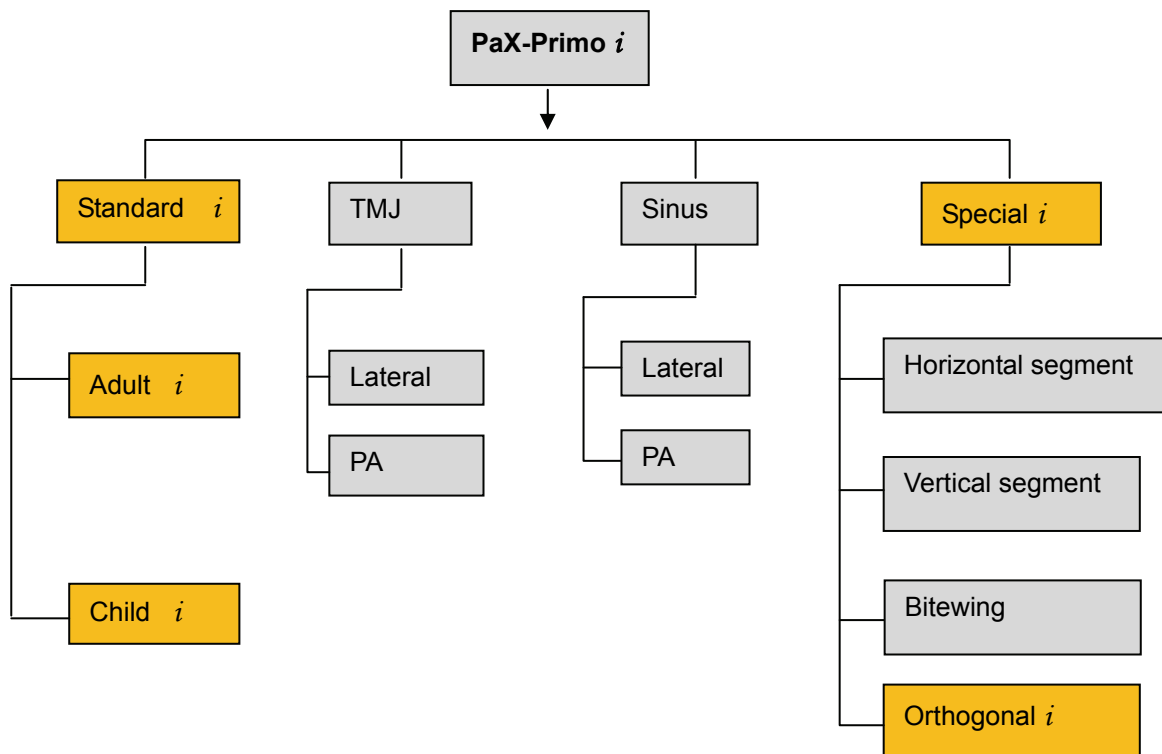

6.2 How the AUTO FOCUSING(AF) mode works

In general, the panoramic images are taken along the trajectory through the averaged arch of the patient and reconstructed later. But the patients' arches differ in shapes individually and correct positioning of them to ensure quality images is not easy. Moreover, to keep the correct positioning while being imaged is more difficult. These would lead to the inferior images. The auto-focusing technology comes into play. In other words, the AUTO FOCUSING, which is incorporated into design of the PaX-Primo's intelligence model to produce optimal digital diagnostic images, is outstanding in its performances. That is, it *intelligently* reconstructs a final diagnostic image by *selecting the optimal single layer* in different regions of the image to minimize image distortion in every panoramic image taken.

An artificial intelligence algorithm is employed to perform the following functions automatically.

6.2.1 Reconstructing procedures

1. Acquire the multiple layers of the images in a region.
2. Select the best single layer closest to center of the patient teeth among them.
3. Place the optimal image layer on the appropriate region of interest.
4. Repeat 1 through 3 until the entire region of the arch is scanned and imaged.
5. After internal manipulation for the further processing, the final reconstructed image is acquired.



6.2.2 Graphical explanation

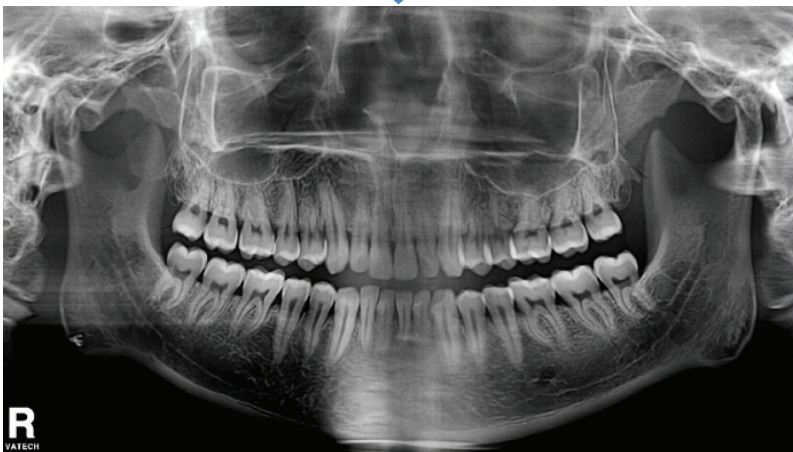
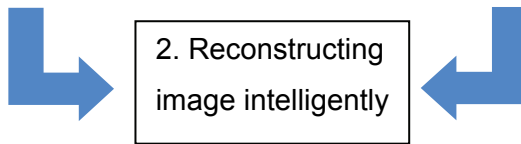
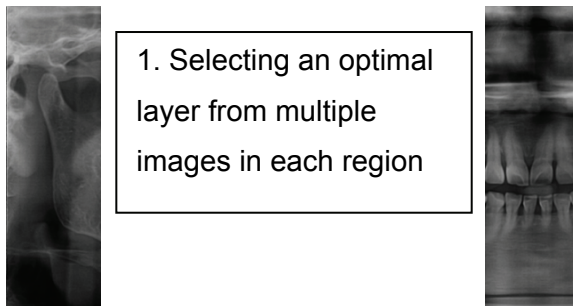
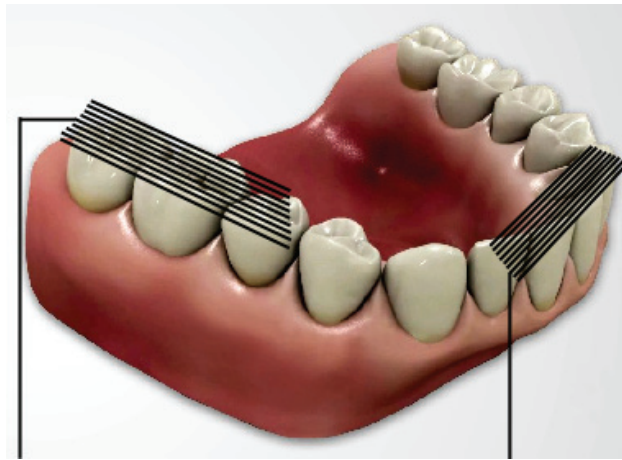

6.2.3 Typical example

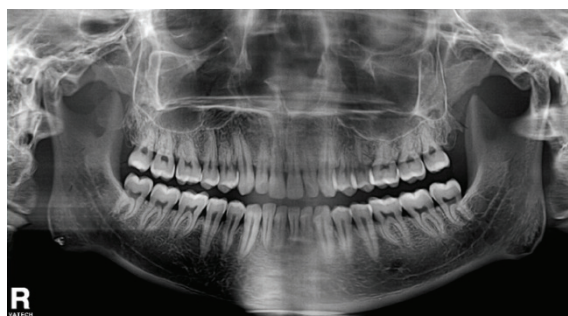
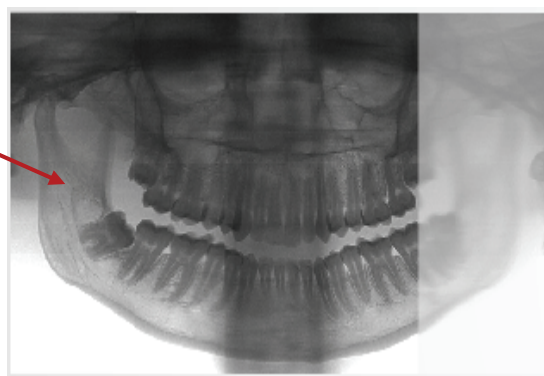
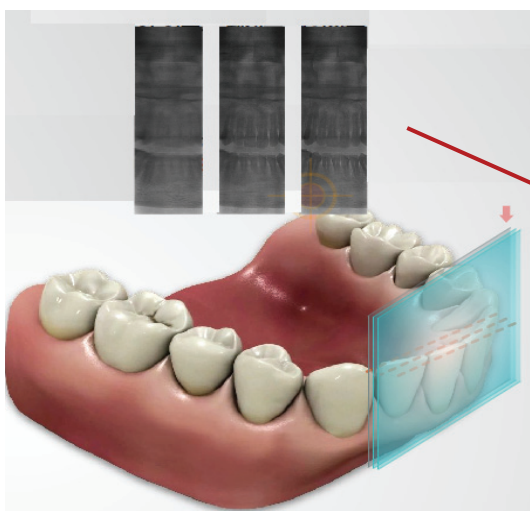
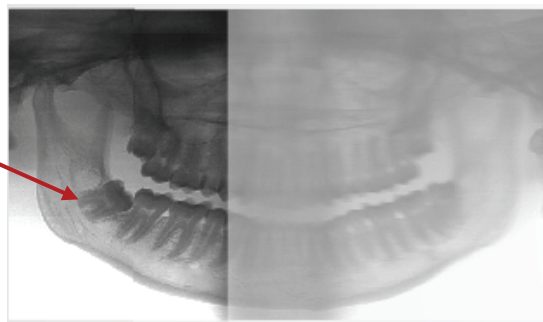
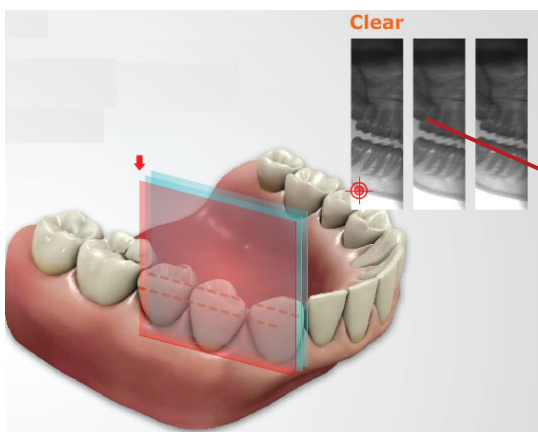
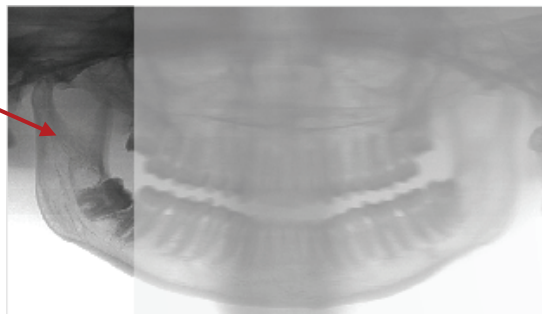
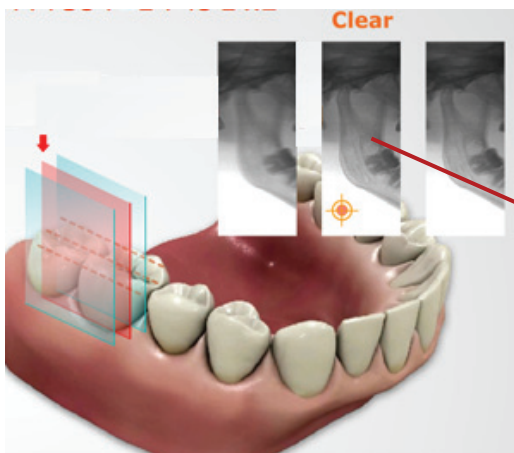

Reconstructed image



6.2.4 Comparisons between standard and AUTO FOCUSING imaging

Case 1: Front teeth view is contracted

Circumstance: Bite block inserted too deep into the mouth

At the standard (disabled AUTO FOCUSING)

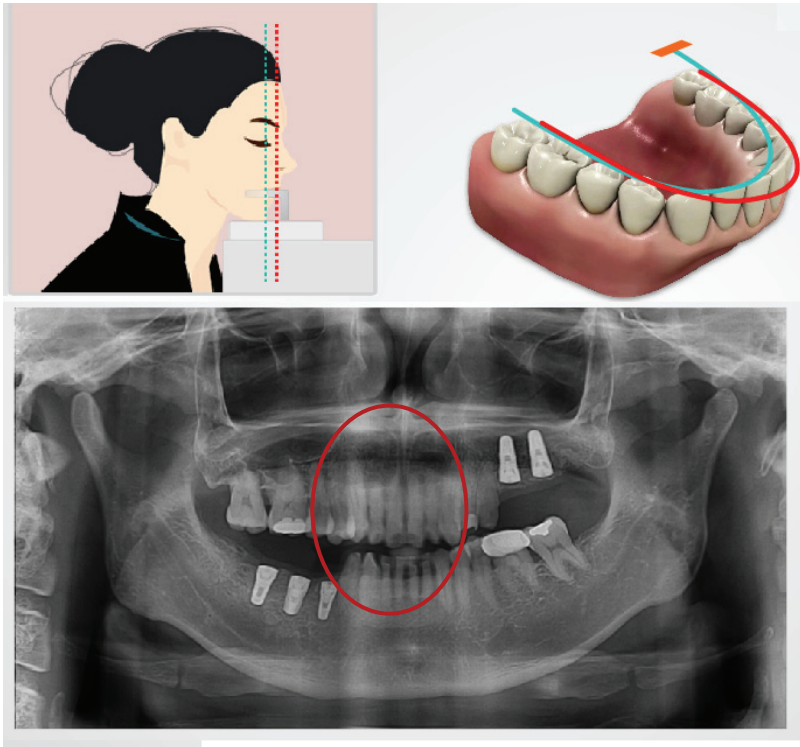

AUTO FOCUSING enabled

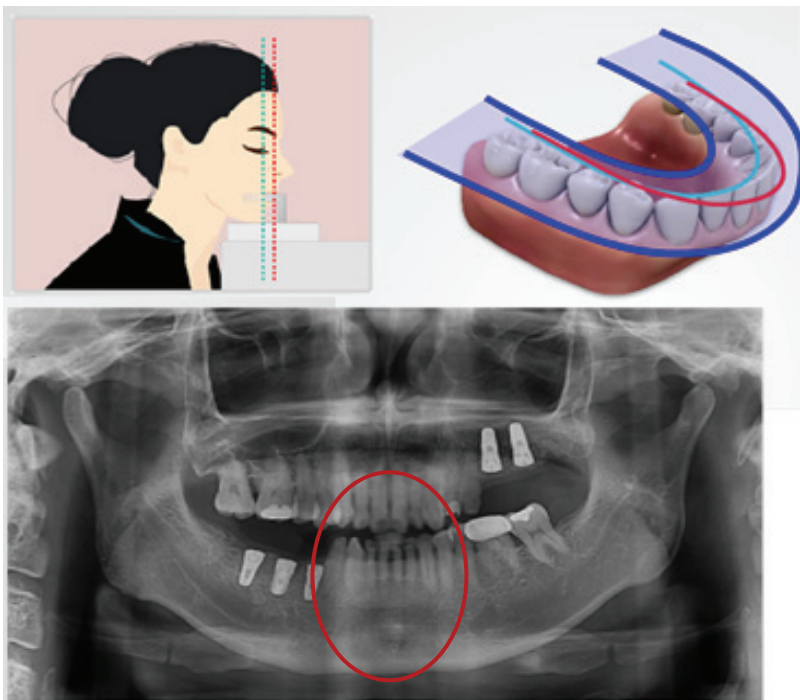

Case 2: Front teeth view is enlarged locally

Circumstance: the patient is positioned off the correct position

At the standard (disabled AUTO FOCUSING)

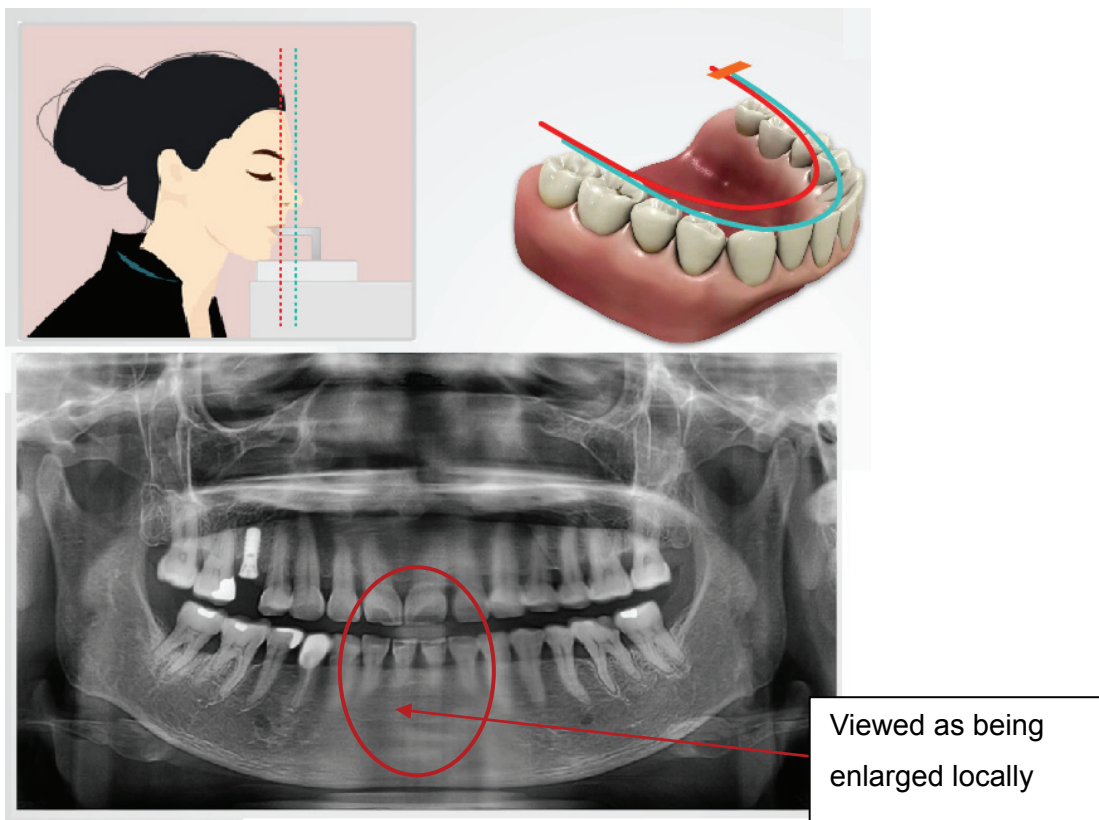

AUTO FOCUSING enabled

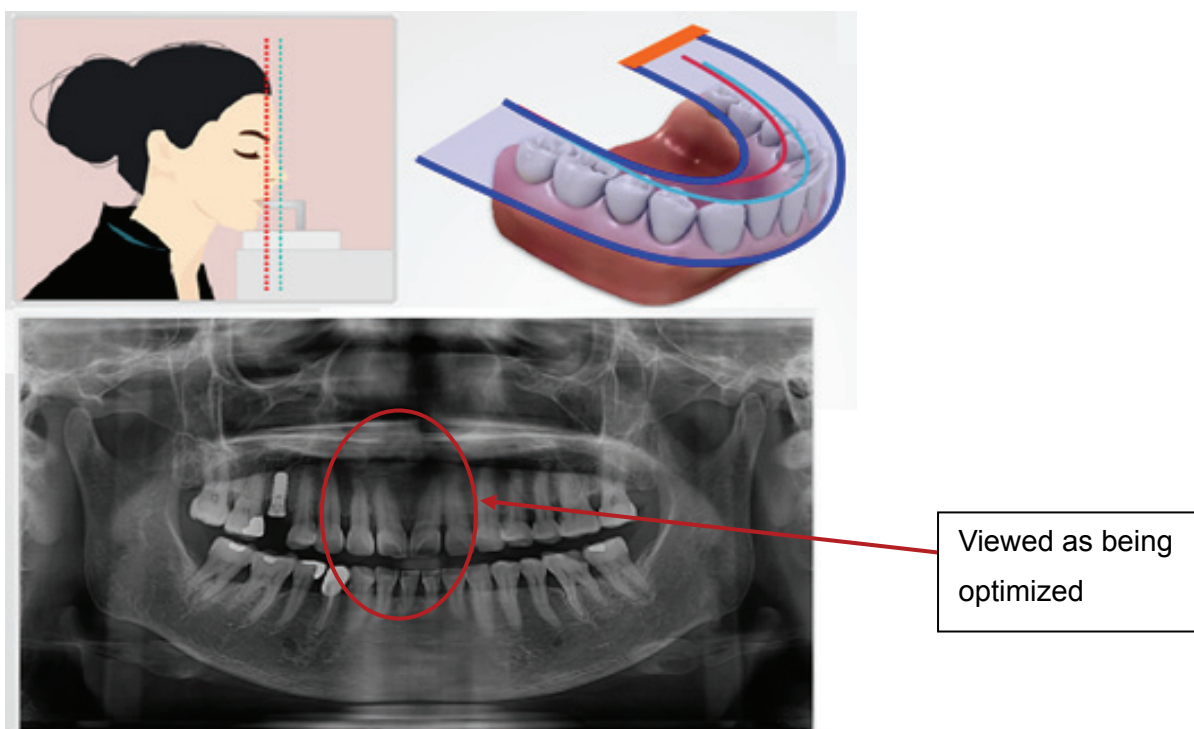



Case 3: View from the right and left sides has the different magnification

Circumstance: the patient accidentally turned neck right or left

At the standard (disabled AUTO FOCUSING)

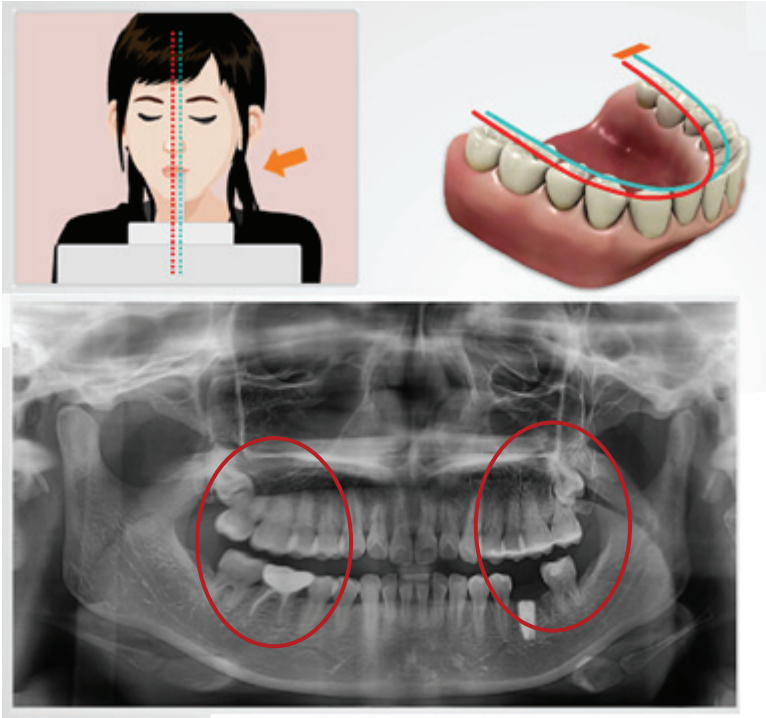

AUTO FOCUSING enabled

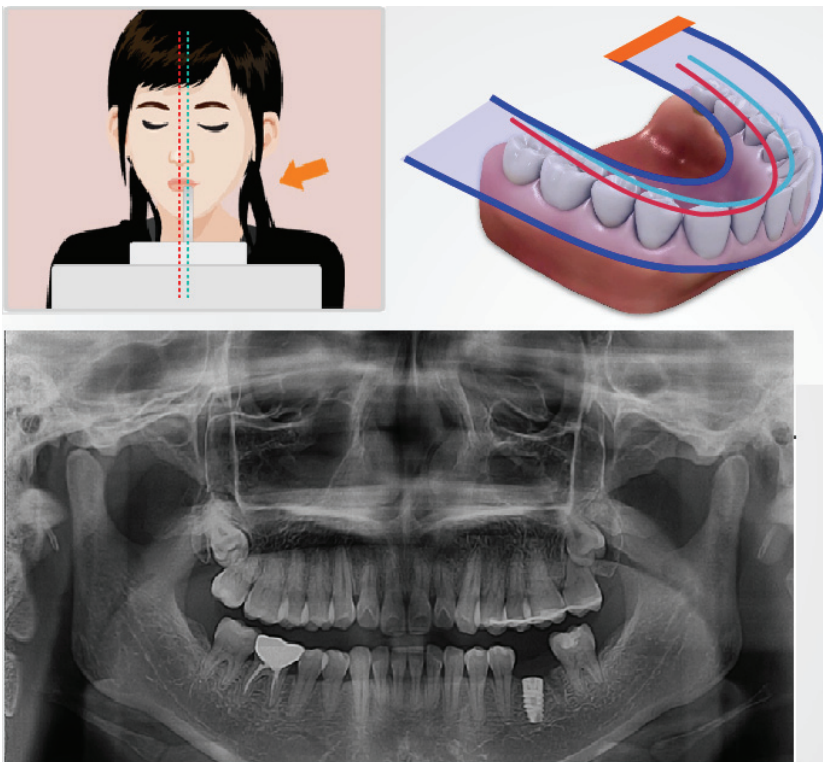

Chapter 7 Maintenance

7.1 Storage and transportation

- Ambient temperature: -20 °C ~ 50 °C
- Relative humidity: 10%~ 90%
- Ambient, atmospheric pressure: 500~1060 hPa
- Although it can be allowed to be stored up to 10 degree of slope, it is recommended that equipment be used and stored on flat, even surface.

7.2 Sterilization and disinfection

- Sterilization and disinfection should be performed thoroughly for the items like handle frame, chin rest and bite block among other things, with which patients' contacts frequently are made.
- Disinfect the affected area with 2% ammonia solution and in particular the bite block used by previous users should be sterilized for more than 15 min. at 121 °C.
- Ultrasonic cleansing, if necessary, should be carried out.

7.3 Regular maintenance and treatment

- Don't unplug various kinds of cables by force.
- Don't keep equipments or items susceptible to water or humidity.
- Keep those in places not affected by temperature, ventilation, sun light, dust, salt and so forth.
- Avoid the area vulnerable to some degree of slope, vibration and shock.
- Avoid area near to chemical storage and gas-filled storage.
- Keep miscellaneous materials well organized for next use.
- In case of cleaning equipment, wipe gently the surface with soft, dry tissue evenly
In extreme case of water or any forms of liquid being spilled into the inside equipment, turn off equipment immediately and ask help for a qualified person.

7.4 Regular checkup

- Equipment and components should be maintained on regular basis.
- When you are trying to use equipment after it has left unused for long time, always make sure that equipment are running without any problems and then put into operation.
- Qualified persons only are allowed to get access to equipment.



- Confirm voltage frequency and power consumption meet the requirement specified on the equipment.
- Make sure that the equipment is well grounded.

7.5 General Notes

7.5.1 Preoperational stage

1. Check the very basic things like switch contact and polarity and cable conditions are met with requirement.
2. Equipment ground condition is satisfactory.

7.5.2 In-use stage

1. Keep always eyes on the patient and equipment during operation to make sure something wrong might happen.
2. If so, stop operation immediately and care must be taken to correct problems.
3. In case of equipment malfunctioning, there are few things that can be done on the field except for replacing fuses. Do not make wild guess to jump into wrong decision. Always ask help from the manufacturer for the further information.
4. Never try to revise equipment, including wires or cables. There is nothing that can be changed on the field. By doing so, it can cause problems that may be beyond the repair.

7.6 X-Ray generation and warning

1. Use the extended cable, while taking image, to make operators less susceptible to X-Ray source.
2. This equipment is made dental service and generates X-Ray safely.
But inappropriate handling may do the patient and operator harm.
Thus the unauthorized never try to operate this equipment, let alone to repair.
3. The operators have all the responsibilities to check conditions of equipment regularly.
This is well defined in the code of manual and in internal education session.
4. Any means of warning signal should be employed to keep patient and operator on alert when something unexpected happens.
5. For the pregnant and the patient having needs for particular attention, consult with medical doctor before taking images.
6. Always keep in mind that all the requirements and conditions specified on the international law should be applied for installing and using this kind of X-Ray equipment.

7.7 Daily maintenance tasks

| Accessories | Maintenance tasks |
|---|---|
| Panoramic bite block | Sterilize with cold sterilization or autoclave up to 134 degree before the next patient is X-rayed |
| Temple support | Sterilize the head support and chin rest with medical-grade 76% alcohol disinfectant before next patient is X-rayed |
| Chin rest(panoramic, sinus and TMJ) | Sterilize the head support and chin rest with medical-grade 76% alcohol disinfectant before next patient is X-rayed |
| All components that come into contact with patient and operator | Sterilize components with medical-grade 76% alcohol disinfectant before next patient is X-rayed |
| Outer covers of Unit | <p>Wipe the unit with a dry cloth at the end of each day's operation.</p> <div style="display: flex; align-items: center;">  <div style="margin-left: 10px;"> <p>Do not use detergents or solvents to clean outer covers of the unit.</p> </div> </div> <p>WARNING</p> |



Chapter 8 Technical specifications

8.1 Unit technical specifications

8.1.1 General information

- X-ray beam: Fan Beam
- Reconstruction Algorithm: A real time reconstructing algorithm
- Dynamic Range: 14 bit
- Scan Time (sec) at normal: 9.7 sec (typical). (2~13.5 sec.)
- Rotating Unit Scan Angle (degree): 240
Actual rotating angle around the object
- X-ray Exposure Angle (degree): 220

Actual spanning angle to expose the object to X-Ray: In fact the instant that the rotating unit turns by 10 degrees, the X-Ray exposure starts and stops at 10 degrees before the rotating unit reaches the full rotation: $240-10-10=220$

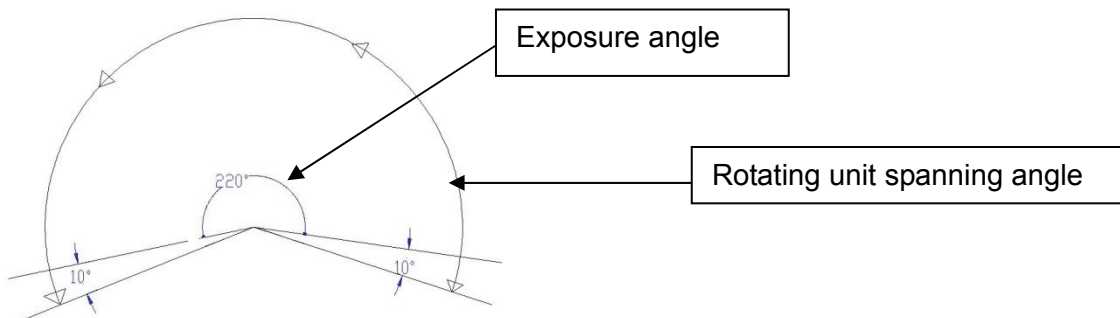

- Patient Position: Standing. Wheel chair-confined patients
- Patient Alignment: 3 guiding light beams
- Reconstruction Time: About 45sec
- Focal spot size: 0.35 X0.5 mm
- FDD (SID): 531.2 mm
- Magnification: 1.31
- Sensor type: CMOS (Area mode)
- Pixel pitch: 100um
- Image pixel size: 100um
- Active pixel array: 1504x60 pixels
- Active area: 150.4x6.0mm
- Data acquisition speed: 100Mbps: Ethernet communication
- Weight: 75 kg

8.1.2 X-ray Generator

- continuous type
- High frequency generator, constant potential, micro processor controlled
- Ripple < 4%
- Inverter frequency 36 kHz push-pull
- Tube type D-051, stationary anode type
- Nominal power below than 1.3 KW
- Tube voltage 50 – 80 kV (adjustable by 1 kV)
- Tube current 2 – 10 mA (adjustable by 1 mA résolution)
- High voltage DC
- Exposure time
- Cooling by force, one minute for cooling / Protect □ 50°C

8.1.3 X-ray Tube(Toshiba D-051)

- Focal spot size 0.35*0.5 mm
- Heat storage capacity 30 kJ (40 Khu)
- Total filtration 2.8 mm Al eq

8.1.4 Electrical Characteristics

- Power supply voltage AC 110/230V ± 10%
- Frequency 50/60 Hz
- Power rating 2.0KVA



8.1.5 Dimension of beam limiting device: collimator

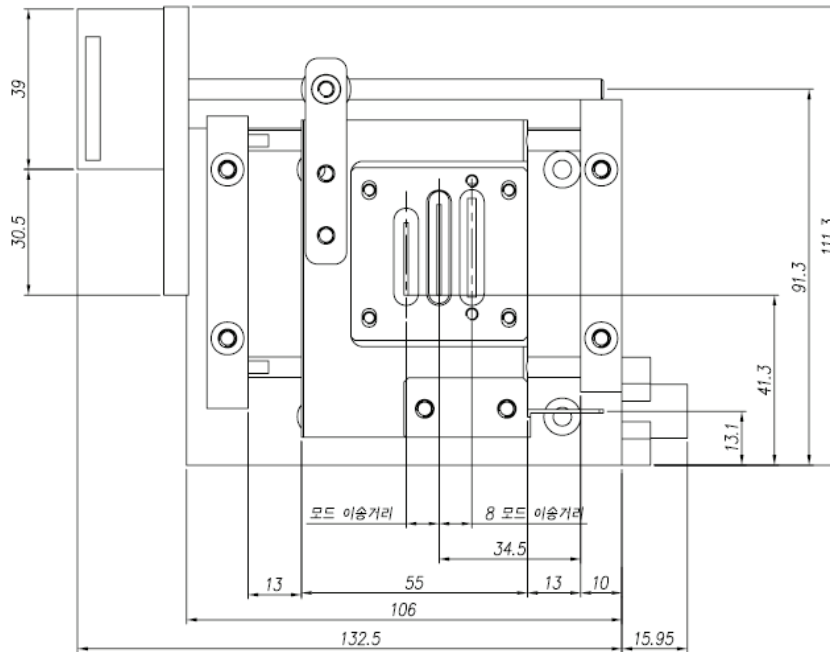

8.1.6 Environmental Characteristics

- Operating temperature 10 ~ 30 °C
- Operating relative humidity 30 ~ 75%
- Operating atmospheric pressure 700 ~ 1060 hPa
- Transport and storage temperature -20 ~ 70 °C
- Transport and storage relative humidity < 90% non-condensing
- Transport and storage atmospheric pressure 500 – 1060 hPa

8.1.7 Dimension of the Unit

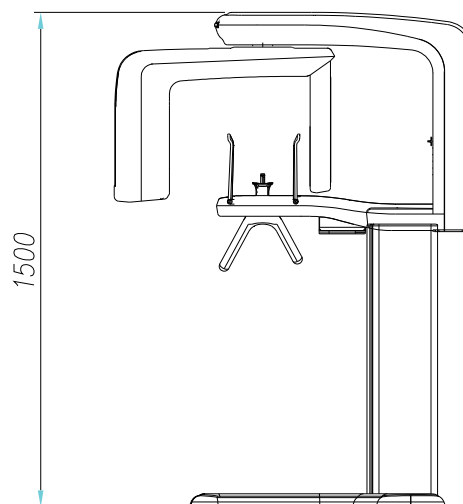
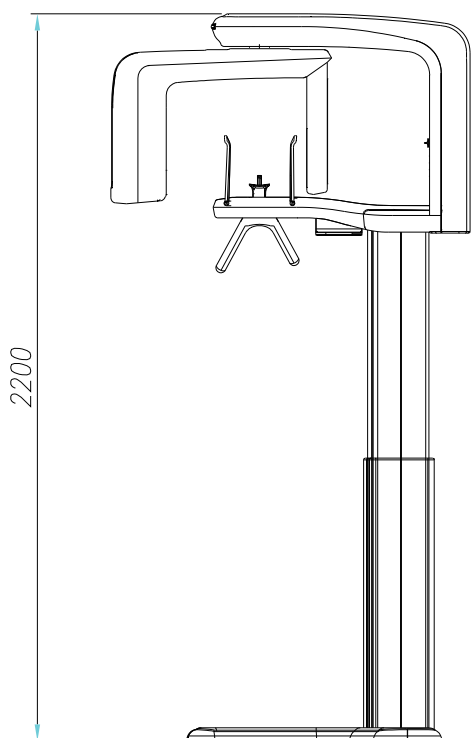
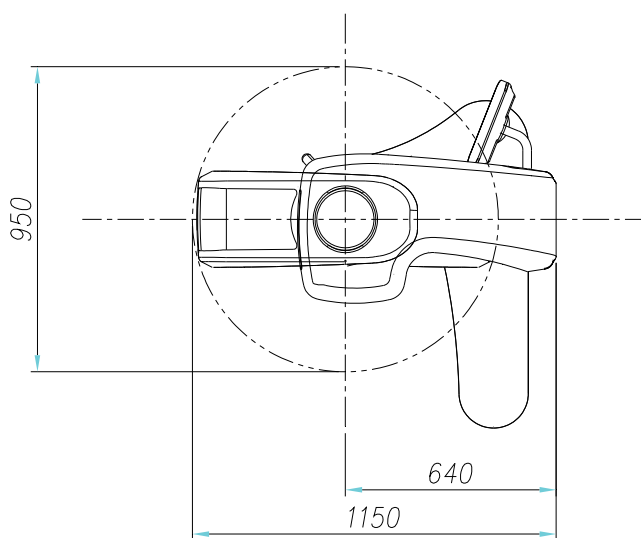

(Unit: mm)



The height, 2200mm, represents the maximally allowed length using extensible (adjustable) column.



8.1.8 Focal spot distance

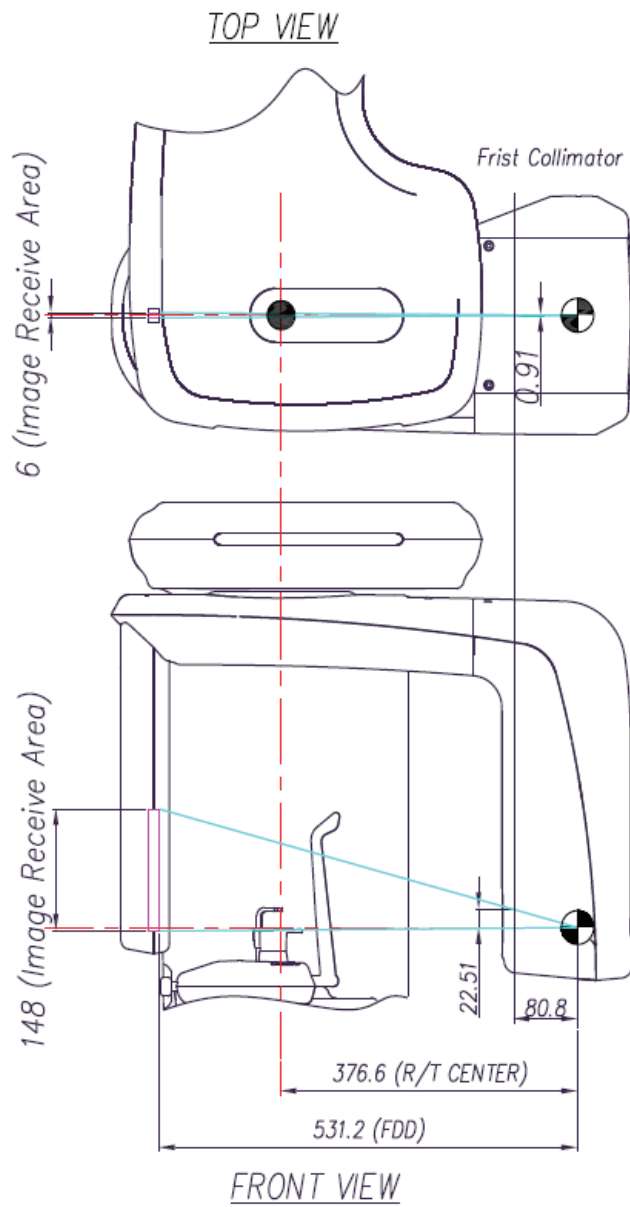

8.2 X-Ray generator technical specifications

8.2.1 X-Ray Tube Specification

D-051

- Tube voltage: 50 ~ 100 kV
- Tube current: 1 ~ 22 mA
- Focal spot: 0.5 mm
- Inherent filtration: 0.8 mm Al
- Added filtration: 2.0 mm Al
- Total filtration: 2.8 mm Al
- Filament characteristics: 3.5~4.9V 3.5A(max. filament current)
- Anode angle: 5°
- Anode Hu: 28000J
- Anode cooling rate: 265W
- Input energy at 1 sec: 1750W
- Tube target material: Tungsten

Maximum Rating Charts
(Absolute maximum rating charts)

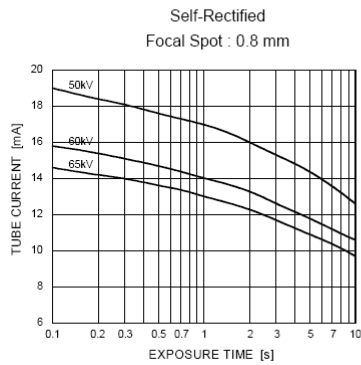

Emission & Filament Characteristics

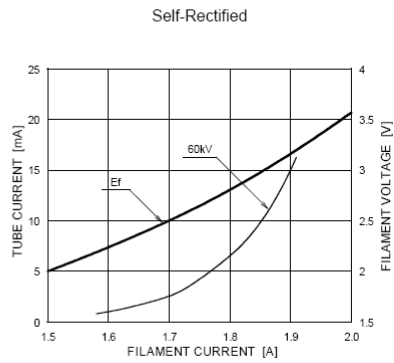

Anode Thermal Characteristics

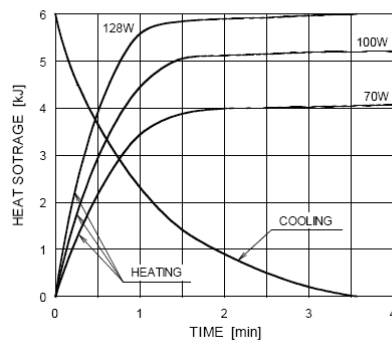



8.2.2 High voltage generator

- Tube voltage: 50 to 80kV constant potential
- Tube current: 2 to 10 mA direct current

8.2.3 X-Ray generation controller

- Focal spot length to Sensor: 678 mm
- Exposure time: 20sec.
- Cooling: 1 min. cooling time
- X-Ray generation limit: 50 to 90 kV and 2 to 10 mA

8.2.4 Beam limiter and its dismantled view

- Whole size: 35mm x38 mm x4mm
- Hole size: 0.87 mm x 18.48 mm x 2.5 mm
- Material used: Lead (Pb)

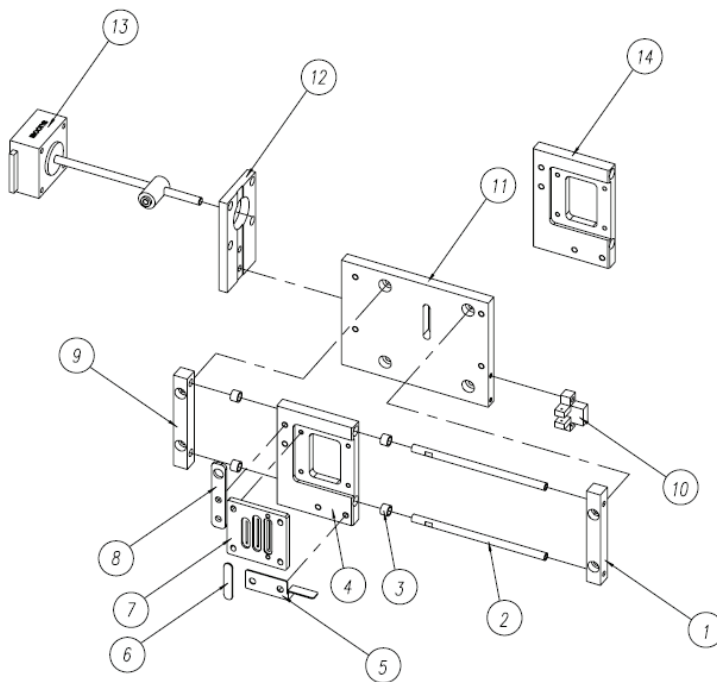

8.3 Classification

- Classification according to the degree of protection against ingress of water as detailed in the current edition of IEC 529... IPXO Secondary collimator at CEPH to reduce scattered radiation
- According to the mode of operation:
Continuous operation with intermittent loading

8.4 Standards

This product is designed and produced to meet the following standards:

EN 60601-1, EN 60601-1-3, EN 60601-2-7, EN 60601-2-28, EN 60601-2-32,

EN 60601-1-2, EN 61000-3-2, EN 61000-3-3

EN ISO 9001, EN ISO 13485

8.5 Marks & Graphic symbols



TYPE B Equipment



Radiation hazard

CE 0499

CE symbol grants the product compliance to the European Directive for Medical Devices 93/42 as a class IIB device. Authorized by **Grand-Duche De Luxemburg.**

EC Representative; DentalHolding Sp.Zo.o

ul. Chalubinskiego 8

00-6 Warszawa Poland

Tel: +48-22-313-08-08

Fax: +48-22-313-08-90



Chapter 9 Service

To guarantee the user and patient safety and ensure image quality this unit must be checked on regular, periodic bases by a qualified person from the VATECH.

Please refer to the service manual for complete servicing information.

Chapter 10 Disposal of the Unit

In order to reduce the environmental contamination, this unit is basically designed to be as safe as possible to use and dispose. Many parts inside and outside the unit except for some like X-ray tube are environment-friendly and can be recycled for the next uses.

All parts and components containing hazardous materials must be disposed of according to the regulation governing these issues.

| Part | Main materials to be disposed | Recyclable materials | Waste disposal site | Hazardous waste Needs separate collection |
|------------------------|-------------------------------|----------------------|---------------------|--|
| Frame and covers | Aluminum and plastics | • | | |
| Motors | | • | | |
| Boards | | • | | |
| Cables and transformer | Copper | • | | |
| | Steel | • | | |
| | Oil | | • | |
| Packing | Wood | • | | |
| | Cardboard | • | | |
| | Paper | • | | |
| X-Ray tube | | | | • |
| Sensor head | Return sensor head to VATECH | | | |
| Other parts | | | • | |

Chapter 11 Emergency Measures

If a problem occurs while operating the product, do take the very basic emergency measures by consulting the following tables. If problem persists, please request support through the customer support information service at point of contact appeared on the back of this manual.

| ● If device is not moving | |
|-------------------------------|--|
| Cause | Solution |
| Power failure | Check the power supply to device. |
| Initialization status | Wait until the device has initialized and then try again. |
| Control PC connection failure | Check the connection status of Serial Port (RS232) connecting PC and device. |

| ● If exposure switch is not working | |
|-------------------------------------|---|
| Cause | Solution |
| Ready status | Check whether it is ready for capturing at the imaging program. |

| ● If imaging is not working | |
|-----------------------------|--|
| Cause | Solution |
| Initialization status | Wait until the device has initialized and then try again. If it persists, turn it off and start again. |

| ● If Laser Beam is turned off and patient alignment cannot be performed | |
|---|--|
| Cause | Solution |
| Alignment time expired | Press “Position” Button and carry out patient alignment again. |



Moisture may cause fatal damage to the electric equipments. Be careful not to allow leakage or penetration of water around it.



Chapter 12 Recommended X-Ray Exposure Table

12.1 Pano Standard

| Gender/Figure | Hard | Normal | Soft |
|---------------|--------------|--------------|--------------|
| Man | 72 kVp, 8 mA | 70 kVp, 8 mA | 68 kVp, 8 mA |
| Woman | 70 kVp, 8 mA | 68 kVp, 8 mA | 66 kVp, 8 mA |
| Child | 66 kVp, 7 mA | 66 kVp, 7 mA | 66 kVp, 7 mA |

12.2 Pano Special

| Gender/Figure | Hard | Normal | Soft |
|---------------|--------------|--------------|--------------|
| Man | 72 kVp, 8 mA | 70 kVp, 8 mA | 68 kVp, 8 mA |
| Woman | 70 kVp, 8 mA | 68 kVp, 8 mA | 66 kVp, 8 mA |
| Child | 66 kVp, 7 mA | 66 kVp, 7 mA | 66 kVp, 7 mA |

Copyright by © 2009 Vatech

The information in this document is subject to change without notice and does not represent a commitment on the part of the vendor, who assumes neither liability nor responsibility for any errors that may appear in this manual.

This document contains materials protected under the International Copyright Laws. All rights reserved. No part of this manual may be reproduced, transmitted, or transcribed without the expressed written permission of the manufacturer and authors of this manual.

If you do not properly set the device causing it to malfunction or fail, we cannot assume any responsibility.

VATECH**Tel ▶ +82-31-679-2073****Fax ▶ +82-31-377-1882****Email ▶ gcs@vatech.co.kr****Head Quarters ▶ 473-4, Yun-Min Bldg., Bora-dong,****Giheung-gu, Yongin-si, Gyeonggi-do, Korea****Factory ▶ 23-4, Seokwoo-Dong, Hwaseong-si, Gyeonggi-do, Korea****CE 0499**

CE symbol grants the product compliance to the European Directive for Medical Devices 93/42 as a class

IIB device. Authorized by **Grand-Duche De Luxemburg**.

EC Representative; DentalHolding Sp.Zo.o**ul. Chalubinskiego 8****00-6 Warszawa Poland****Tel: +48-22-313-08-08****Fax: +48-22-313-08-90**

[Release Version 1.0.1
Dated Nov. 13th, 2009]



VATECH Co., Ltd.

473-4, Bora-Dong, Giheung-Gu, Yongin-Si
Gyeonggi-Do, Korea 446-904

Tel 82.31.679.2050 Fax 82.31.377.1882
www.vatech.co.kr

