

Green 16™

User manual

Model : PHT-65LHS
Version : 1.48

- English



Full version

vatech

Notice

Thank you for purchasing the **Green 16 (PHT-65LHS)** extra-oral imaging system.

The primary mission of **Green CT** is to aid dental professionals in providing excellent care in a safe environment that promotes healing. However, **Green CT** is not a product name or a brand name.

Green 16 (PHT-65LHS) is an advanced digital diagnostic system that incorporates PANO, CEPH (Optional), CBCT, and 3D MODEL Scan imaging capabilities into a single system.

This manual describes how to operate the **Green 16 (PHT-65LHS)** system. It is recommended that you thoroughly familiarize yourself with this manual to make the most effective use of this equipment.

Observe all cautions, safety messages, and warnings that appear in this manual.

Due to constant technological improvement, the manual may not contain the most updated information and is subject to change without prior notice to the persons concerned. For further information not covered in this manual, please contact us at:

VATECH Co., Ltd.

Phone: +82-1588-9510

E-mail: gcs@vatech.co.kr

This document is originally written in English.

Green 16 (PHT-65LHS) is referred to as “equipment” in this manual.

Manual Name: Green 16 (Model: PHT-65LHS) User Manual

Version: 1.48

Publication Date: 2022-05

Document Number: VDH-UM-068(16)

Table of Contents

Notice		iii
Table of Contents		iv
1.	Introduction	7
	1.1 Overview	7
	1.2 Indications for Use	7
	1.3 Intended Purposes	7
	1.4 Intended User Profiles	8
	1.5 Contraindications	8
2.	General Information	9
	2.1 Manufacturer's Liability	9
	2.2 Owner and Operator's Obligations	9
	2.3 Conventions in this Manual	10
	2.4 Marks and Symbols	11
3.	Warnings and Precautions	15
	3.1 General Safety Guidelines	15
	3.2 Electricity-related Safety Precautions.....	19
	3.3 Radiation Safety.....	21
	3.4 Warnings.....	22
4.	Imaging System Overview	25
	4.1 System Components.....	25
	4.2 Features	25
	4.3 Imaging System Overview	25
	4.4 Standards and Regulations	26
	4.5 Operating Principles.....	27
	4.6 Imaging System Configuration	27
	4.7 Equipment Overview	29
5.	Imaging Software Overview	46
	5.1 PC Specifications (Recommended)	46

5.2	EzDent-i.....	47
5.3	Console Software.....	48
6.	Getting Started	52
6.1	Turning on the Equipment.....	52
6.2	Running the Image Viewer (EzDent-i)	53
7.	Acquiring PANO Images	57
7.1	PANO Imaging Program Overview	57
7.2	Setting Exposure Parameters	62
7.3	Patient Positioning	68
7.4	X-ray Exposure	82
7.5	Finishing the Scan	83
7.6	Checking the Captured Images	83
8.	Acquiring CEPH Images (Optional)	85
8.1	CEPH Imaging Program Overview	85
8.2	Setting Exposure Parameters	87
8.3	Patient Positioning	91
8.4	X-ray Exposure	102
8.5	Finishing the Scan	103
8.6	Checking the Captured Images	103
9.	Acquiring CBCT Images	104
9.1	CBCT Imaging Program Overview	104
9.2	Setting Exposure Parameters	108
9.3	Acquiring a Double Scan Image (ptional).....	113
9.4	Patient Positioning	117
9.5	X-ray Exposure	127
9.6	Finishing the Scan	128
9.7	Checking the Captured Images	128
10.	Acquiring 3D MODEL Scan Images	129
10.1	3D MODEL Scan Imaging Program Overview	129
10.2	Setting Exposure Parameters	130

10.3	MODEL Positioning	132
10.4	X-ray Exposure	133
10.5	Checking the Captured Images	134
11.	Troubleshooting	136
11.1	Troubleshooting	136
11.2	Error Codes.....	137
12.	Cleaning and Disinfection	141
12.1	Cleaning	142
12.2	Disinfection	143
13.	Maintenance	145
13.1	Regular Maintenance	145
14.	Disposing of the Equipment	147
15.	Technical Specifications	149
15.1	Mechanical Specifications	149
15.2	Technical Specifications	152
15.3	Electrical Specifications	157
15.4	Environmental Specifications.....	158
16.	Appendices	160
16.1	Recommended X-ray Exposure Tables	160
16.2	X-ray Dose Data	170
16.3	Electromagnetic Compatibility (EMC) Information	179
16.4	Hand-wrist Image Evaluation References.....	184
16.5	Acquiring Images for Pediatric Dental Patients	188
16.6	Abbreviations	199

1. Introduction

1.1 Overview

Green 16 (PHT-65LHS) is an advanced 4-in-1 digital X-ray imaging system that incorporates PANO, CEPH (Optional), CBCT, and 3D MODEL Scan imaging capabilities into a single system.

Green 16 (PHT-65LHS), a digital radiographic imaging system, acquires and processes multi-FOV diagnostic images for dentists.

Green 16 (PHT-65LHS) is a complete digital X-ray system equipped with imaging viewers, an X-ray generator, and a dedicated SSXI detector.

The digital CBCT system is based on a CMOS digital X-ray detector. The CMOS CT detector captures 3D radiographic images of the head, neck, oral surgery, implant, and orthodontic treatment.

Green 16 (Model: PHT-65LHS) can also acquire 2D diagnostic image data in conventional panoramic and cephalometric modes.

1.2 Indications for Use

Green 16 (Model: PHT-65LHS) is intended to produce panoramic, cephalometric, or 3D digital x-ray images. It provides diagnostic details of the dento-maxillofacial, ENT, sinus, and TMJ for adult and pediatric patients. The system also utilizes carpal images for orthodontic treatment. The device is to be operated by healthcare professionals.

1.3 Intended Purposes

- Determination of the extent of lesions, tumors, cysts, etc., which cannot be adequately visualized on plain films
- Diagnosis of foreign bodies or displaced roots involving the maxillary sinus
- Diagnosis of bone diseases, cysts, etc., affecting the temporomandibular joints
- Identifying the relationship of the inferior dental canal to a tooth/lesion that is to be removed
- Assessment of fractures on maxilla, mandible, condylar neck, and fractures of teeth where plain film imaging is equivocal
- Visualization of the 3D anatomy of the alveolar clefts
- Diagnosis of un-erupted teeth impacted teeth and odontomas
- Diagnosis of root resorption of teeth
- Assessment of cleft palate
- Diagnosis of CRS (chronic rhinosinusitis)
- Examinations of the airways for measuring the volume and dimensions of air passages

- Reconstruction of position, malformations, and fractures of maxilla & mandible bones, nasal bone, and paranasal sinuses as 3D pictures for operational planning and patient education
- Planning any surgery where a 3D analysis of the jaw is required
- Storing Plaster Casts in 3D data

1.4 Intended User Profiles

Considerations	Requirement Description
Education	<ul style="list-style-type: none"> ▪ Licensed dentists or dental hygienists, radiologists, and graduates of relevant bachelor's degrees (national qualifications)
Knowledge	<ul style="list-style-type: none"> ▪ Understanding the treatment and diagnosis of dental disease ▪ Understanding the terms and guidance of hardware and software of a diagnostic medical radiation device and recognizing device connection, installation, and operating conditions
Language understanding	<ul style="list-style-type: none"> ▪ Understanding how to use manuals (English / Korean) or ▪ Understanding other languages provided
Experience	<ul style="list-style-type: none"> ▪ Understanding the objectives and effects of the diagnosis and treatment of dental disease using diagnostic medical radiation devices ▪ Understanding the normal operation of diagnostic medical radiation equipment ▪ Understanding the contents of the User Manual

1.5 Contraindications

Do not use this device other than for the intended purpose.
 There are no other contraindications to it since the technology is at a controllable level in accordance with global standards.

2. General Information

2.1 Manufacturer's Liability

The manufacturers and/or retailers of this X-ray equipment assume responsibility for the safe and normal operation of this product only when:

- A VATECH-authorized technician has installed the equipment.
- The equipment has been installed by all the cautions and conditions required for installation.
- The genuine **VATECH**-approved equipment and components have been used.
- A VATECH-authorized agent has performed all maintenance and repairs.
- The equipment has been used normally by the **User Manual**.
- The equipment damage or malfunction is not the result of an error on the part of the owner or the operator.





2.2 Owner and Operator's Obligations

- This equipment's owner must perform constancy tests regularly to ensure patient and operator safety. Local X-ray safety regulations must perform these tests.
- This equipment's owner must perform regular inspection and maintenance of the mechanical and electrical components to ensure safe and consistent operation (IEC 60601-1).
- This equipment's owner must ensure that both inspection and cleaning follow the maintenance schedule outlined in **Chapter 14. Maintenance**













2.3 Conventions in this Manual

The following symbols are used throughout this manual. Make sure that you fully understand each symbol and follow the instructions accompanied.







Please observe all warnings and safety information included in this document to prevent physical injury and/or damage to the equipment.

 WARNING	WARNING	Indicates information that must be followed with the utmost care. Failure to comply with a warning may result in severe damage to the equipment or physical injury to the operator and/or patient.
 CAUTION	CAUTION	Indicates a situation that demands prompt and careful action, a specific remedy, or emergency attention.
IMPORTANT	IMPORTANT	Indicates a situation or action that could potentially cause problems to the equipment and/or its operation.
NOTICE	NOTE	Emphasizes valuable information or provides useful tips and hints.
	RADIATION	Indicates a possible danger from radiation exposure.
	SINGLE USE	Indicates a component that must be replaced for each new patient.
	ESD susceptibility	Indicates that an item is susceptible to damage from electrostatic discharges.

2.4 Marks and Symbols

Symbols	Description	Location
	Dangerous voltage	Powerboard
	Warns ESD hazard.	MCU board / Board package
	Protective earth (Ground)	Column
	Off (power: disconnected to the Main Power Switch)	Main Power Switch
	On (power: connected to the Main Power Switch)	Main Power Switch
	Alternate current	Label
	Type B Applied Equipment (IEC 60601-1: Degree of protection against leakage current and/or electric shock: Class 1 equipment)	Label
	Radiation hazard	Label
	Indicates the authorized representative in the European Community.	Label
	The CE symbol indicates that this product complies with the European Directive for Medical Devices 93/42/EEC as amended by 2007/47/EC as a class IIb device.	Label
	UL mark No. E476672	Label
	Addresses where the equipment was manufactured.	Label

2. General Information

Symbols	Description	Location
	Indicates that electrical and electronic equipment must not be disposed of as unsorted municipal waste and must be collected separately.	Label
	Indicates that this equipment is classified as a CLASS 1 LASER PRODUCT by IEC 60825-1 ED.3 regulations.	Label
	Indicates the date when the equipment was manufactured.	Label
	Indicates that the user needs to refer to the Instruction Manual.	Label
	Caution: Federal law restricts this device to sale by or on the order of a licensed healthcare practitioner.	Label
	Indicates the manufacturer's serial number to identify the specific equipment.	Label

2.4.1 Label Locations

The label is attached on the right side of the equipment, and it consists of 6 parts, as below.

vatech ①

Product : Computed Tomography X-ray System
 Model: PHT65LHS
 Power Input : 100-240V~, 50/60 Hz, 2.0 kVA
 This X-ray equipment complies with 21 CFR Subchapter J

Mode of operation : Continuous operation with intermittent loading - Needs waiting (until at least 60 times the exposure time) before the next exposure begins.
 Mode de fonctionnement : Fonctionnement continu avec chargement intermittent - A besoin de temps d'attente (au moins 60 fois le temps d'exposition) avant le début de l'exposition suivante

WARNING : X-ray unit may be dangerous to PATIENT and OPERATOR unless safe exposure factors, operating instructions and maintenance schedules are observed.
AVERTISSEMENT : Cet équipement à rayons X peut être dangereux pour les PATIENTS et les OPERATEURS si les facteurs d'exposition sécuritaires, les instructions de fonctionnement et les programmes de maintenance ne sont pas respectés.

13, Samsung 1-ro 2-gil, Hwaseong-si, Gyeonggi-do, 18449, KOREA
 VATECH Co., Ltd. | Website: www.vatech.co.kr
 51 Quai de Dion Bouton 92800 Puteaux France
 Vatech Global France (SARL) MADE IN KOREA

② **CAUTION (PRUDENCE)**

X-RAY / ATTENTION : X-RAY ON
 WHEN EQUIPMENT IN OPERATION
 X-RAY / ATTENTION : X-RAY ACTIVE
 LORSQUE L'EQUIPEMENT EST EN
 FONCTIONNEMENT

**CLASS 1
LASER PRODUCT**

The laser diode, Class 1, complies with 21 CFR 1040.10 and 1040.11 except for deviations pursuant to laser notice No. 50, dated June 24, 2007, classified by 60825-1 ED-2 ④

③ **X-RAY GENERATOR**

Model : DG-07E22T2
 X-ray Tube : D-0525B / Canon
 Focal Spot : 0.5 x 0.5 mm (IEC 60336)
 Output : Max. 99 kV / Max. 16 mA
 Inherent Filtration : 0.8 mmAl / 50 kV
 Added Filtration : 1.5 mmAl
 Total Filtration : Min. 2.5 mmAl

MEDICAL - APPLIED ELECTROMAGNETIC RADIATION EQUIPMENT
 ANS/AAMI E660601-1 (2005)
 + AMD 1 (2012), E476672
 CAN/CSA-C22.2
 No. 60601-1 (2014);
 IEC 60601-1-3 (2008), IEC 60601-2-43 (2012)

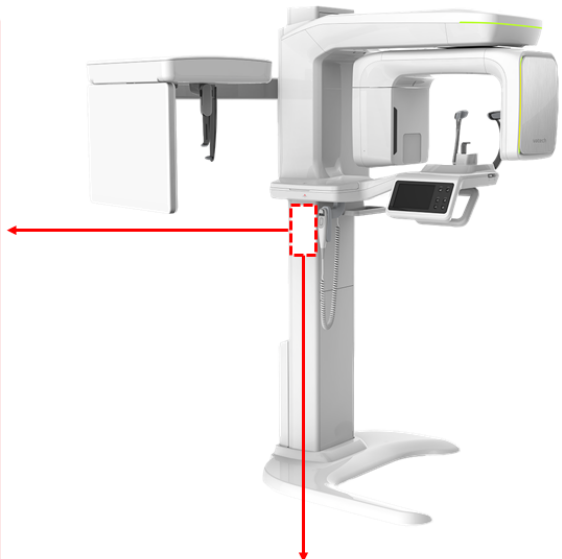

⑤

⑥ For Canada only (with CEPH)

⑥ For Canada only (without CEPH)

CAUTION : X-RAYS
ATTENTION : RAYONS X

Device Identifier
Green 16 SC

CAUTION : X-RAYS
ATTENTION : RAYONS X

Device Identifier
Green 16 SP

NOTICE

The design and contents of the labels may be different in some countries due to local regulations and standards.

2. General Information

No.	Item
1	Green 16 (PHT-65LHS) Main Label
2	CAUTION Label - X-ray / Attention: X-ray on when equipment in operation.
3	X-RAY GENERATOR Label : 1.6 kW Generator
4	CLASS 1 LASER PRODUCT Label
5	Manufacturer Label : The date of manufacture / Serial Number
6	Device Identifier Label (For Canada only) For Canada, the Model is distinguished by Green 16 SC and Green 16 SP. <ul style="list-style-type: none">• Green 16 SC: CEPH included• Green 16 SP: CEPH not included

3. Warnings and Precautions



Be sure to strictly observe all warnings and safety instructions included in this manual.



This X-ray unit may be dangerous to patients and operators unless safe exposure factors, operating instructions, and maintenance schedules are observed.

3.1 General Safety Guidelines

Operator qualifications

This equipment may only be operated by personnel adequately trained in its operation.

To operate this equipment, the operator must:

- Have read and understood the **User Manual**.
- Be familiar with the fundamental structure and functions of this equipment.
- Be able to recognize the intermittent operation of this equipment and implement appropriate measures to remedy such irregularities.

General safety precautions

- Follow the instructions specified in this manual to ensure the safety of both the patient and the operator.
- The operator must always maintain vocal/visual contact with the patient during the image acquisition.
- Do not open or remove the cover panels on this equipment. Always have a trained and authorized service technician to inspect and maintain this equipment.
- Do not place any heavy objects on this equipment at any time.
- Do not place any objects within this equipment's field of operation. It may cause property damage.
- Do not push or pull the equipment. Overbalances of the equipment may cause the risk of physical injuries or property damage.
- The operator must instruct the patient to remain still until the equipment arm has stopped moving and the reset motion is completed.
- Observe all local fire regulations. Always keep a fire extinguisher near the equipment.
- The equipment operator must be familiar with this equipment's emergency protocols.

3. Warnings and Precautions

- Ensure that this equipment is always kept away from water, moisture, or foreign substances.
- If this product is exposed to water, moisture, or a foreign substance, immediately turn off the main power of the equipment and contact your **VATECH** technical support representative.
- If there are signs of oil leakage, immediately cease all equipment operations and contact your **VATECH** technical support representative.
- External equipment intended for connection to signal input, signal output, or other connectors, shall comply with relevant IEC Standard (e.g., IEC 60950 for IT equipment and IEC 60601-1series for medical electrical equipment).
- Also, all such combination-system-shall comply with the standard IEC 60601-1 and IEC 60601-1-1 harmonized national standard or the combination. If in doubt, contact a qualified technician or your local representative.
- Any person or organization that installs an external door interlock switch is responsible for ensuring that it has a radiation indicator or equivalent alarm system to show the current state.
- Any serious incident in relation to the device should be reported to the manufacturer and the competent authority of the member state in which the user and/or patient is established.

Ventilation

- Do not close the equipment's ventilation slots in any case. The ventilation obstruction could result in the equipment overheating due to a lack of air circulation.
- Do not spray any liquid or disinfectant on this equipment. The penetration of these substances may damage the electrical and mechanical components inside. Use a soft cloth to disinfect the ventilation slots.
- Always leave enough space around the PC to allow for proper ventilation.

Hygiene



- Ensure to disconnect the equipment from the power when cleaning its surface.
- Do not place liquid or spray near the equipment. Direct contact with liquids can cause an electric shock or damage the system.
- Do not spray cleaners or disinfectants over the equipment.

- All movable patient support components (the Bite, the Chinrest, the Temple Supports, and the Ear Rods) can be cleaned using non-alcohol-based solutions.
- Clean the Support Handles using non-alcohol-based cleaning solutions before taking photos of the next patient.
- Other equipment surfaces, including the Touch Screen, can be cleaned using a soft cloth dampened with a mild cleaning solution.
- New hygiene cover must be provided for each new patient to prevent the transmission of communicable diseases.



Do not use aerosol or spray cleaning agents directly on the surface of the equipment.

Condensation

- Extreme fluctuation in temperature may cause condensation to develop inside the equipment. Do not turn on the equipment until it has reached room temperature.

Cooling

- Allow the proper amount of cooling downtime (for the X-ray tube to cool down) before acquiring the next image.
 - Mode of operation: non-continuous operation (NFPA 70: long time operation) - needs waiting time (at least 60 times the exposure time) before the next exposure begins.
 - Column operation time: Max. 2 min. On / 18 min. Off (Ratio 1:9)
- If the temperature inside the tube head reaches 60 °C (140 °F), X-ray exposure will cease, and an error message will be displayed. Normal X-ray capabilities will resume after the generator reaches 58 °C (136.4 °F).
- If the fan (optional) is installed, it automatically operates when the temperature surrounding the tube head reaches the pre-defined level: 40 °C (104 °F). The setpoint temperature is configurable.

Turning the equipment on / Adjusting the height of the equipment

- Do not position the patient near the equipment while it is initiating, as the patient could be injured if the equipment malfunctions.
- Ensure that the patient is kept clear of the equipment while adjusting its height.

Emergency stop

- If a problem occurs during image acquisition, press the red **Emergency Stop Switch** to immediately stop all moving parts and cut off all power to the equipment. (**Emergency Stop Switch** is located under the bottom of the Vertical Frame. Turn the switch in the direction of the arrow to reboot the equipment.)

Trouble-free operation

- Never use this equipment in an environment that is susceptible to explosion.
- Always operate the equipment within a temperature range of 10 °C to 35 °C (50 °F to 95 °F) for the safe operation. Image quality may deteriorate if the equipment is operated outside of this range.
- Always allow the equipment enough time to warm up (while switched on) if exposed to temperatures below 10 °C (50 °F).
- Only perform X-rays of patients if the system is in full working order.
- Always ensure that equipment movement is not obstructed by the patient's clothing, a medical device (such as a wheelchair), or the patient.
- Do not leave the patient unattended around the equipment.
- Remove all radio-controlled devices, mobile phones, etc., from the X-ray room before image acquisition as these objects may cause the equipment to malfunction.

Modifying the equipment

- Modifying the equipment in any way which may affect the safety of the operator, patients, or other persons is prohibited by law.
- No part of this equipment is serviceable by the operator. A **VATECH** qualified service technician must perform all maintenance and repair of this equipment.
- This product may only be operated with original **VATECH** accessories or third-party accessories expressly approved by **VATECH**.

3.2 Electricity-related Safety Precautions



Connect the equipment to the power outlet with protective earth (PE) connection to avoid electric shock.

- Check the status of the power source, PC, and cables before operating the equipment.
- Ensure that **Main Power Switch** is set off when the equipment is not in use.
- Always disconnect the power supply before cleaning the equipment.
- Always keep electrical cords away from hot appliances or radiators.
- DO NOT place the PC or peripheral equipment connected to the PC near the patient.
- The equipment and PC should be connected to a common protective earth.
- Never overload the equipment's circuit by sharing it with too many appliances.
- Use the same power circuit for the PC and the equipment.

Combining this equipment with other devices

- Do not connect this equipment to devices that are not designated as a part of the system.
- Do not connect this equipment to a Multiple Portable Socket-Outlet (MPSO) or extension cord, which is not provided with the equipment.

Electromagnetic compatibility

- This X-ray equipment complies with IEC standard 60601-1-2.
- Medical electrical equipment is subject to special Electromagnetic Compatibility (EMC) preventive measures. It must be installed and operated as specified in EMC information.
- If high-voltage, radio link, or MRI systems are located within 5 m of the unit, please observe the specifications stated in the installation requirements.
- Portable Radio Frequency (RF) communications equipment may interfere with medical electrical equipment. Therefore, mobile wireless phones in medical offices or hospital environments must be prohibited.
- For more details, refer to **16.3 Electromagnetic Compatibility (EMC) Information**.
- Please also observe the Electro-Static Discharge (ESD) protective measures described.

Static Discharge

- Without observing ESD protective measures, connector pins or sockets bearing ESD warning labels must not be touched or interconnected.



Electrostatic discharge (ESD)

ESD protective measures include

- Procedures for preventing electrostatic charge build-up (e.g., temperature control, humidification, conductive floor coverings, and non-synthetic clothing)
- Electrostatic discharge of your own body with the frame of the equipment, the protective ground wire, or large metallic objects
- Use of the wristband for grounding

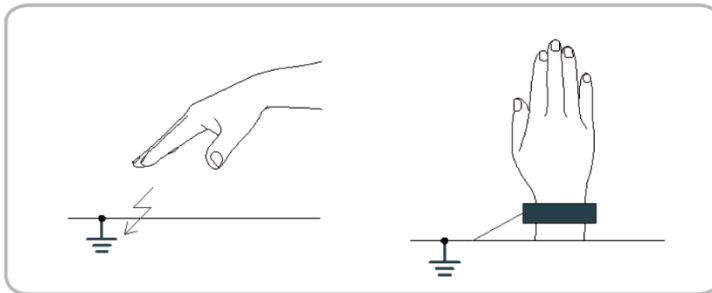

3.3 Radiation Safety



Since rules and regulations concerning radiation safety differ between countries, it is the responsibility of the owner and operator of this equipment to comply with all applicable rules and regulations concerning radiation safety and protection in his/her area.





- This equipment must be housed inside an X-ray shielded room.
- The operator must remain outside a shielded room during X-ray exposure to protect himself/herself from radiation.
- During imaging, the operator must maintain vocal/visual contact with the patient from outside the shielded area.
- The operator should continuously check the status of the patient and the equipment during imaging.
- During imaging, the operator should be at least 2 m (6 feet) away from the equipment.
- The operator must immediately stop imaging if the equipment malfunctions.
- During X-ray exposure, the patient must wear a lead apron with neck and thyroid protection.
- Children and pregnant women must consult with a doctor before X-ray exposure.



As a manufacturer of radiology equipment that conforms to stringent protection standards worldwide, we guarantee the maximum degree of protection against radiation hazards for our equipment.

3.4 Warnings

The following warning statements must be obeyed with the utmost care. Failure to follow these warnings may cause severe damage to the equipment or physical injuries to the patient and the operator.

 WARNING	<ul style="list-style-type: none"> ▪ X-ray equipment is hazardous to the patient and the operator if proper exposure safety measures and operating instructions are not observed. ▪ It is essential to read this User Manual carefully and strictly abide by all warnings and cautions stated.
 WARNING	<ul style="list-style-type: none"> ▪ The 3D image should not be used for screening examinations. Each exam must be justified by demonstrating that the benefits outweigh the risk. ▪ Where it is likely that evaluation of soft tissues will be required as part of the patient's radiological assessment, conventional medical CT or MR should be used instead of dental cone beam imaging.
 WARNING	<ul style="list-style-type: none"> ▪ Like other medical equipment, Green 16 (PHT-65LHS) system uses high-frequency electrical signals that can interfere with implantable devices such as pacemakers and Implantable Cardioverter Defibrillators (ICDs). If the patient has such an implantable device, you should be aware of any interference in its operation and immediately power off the Dental X-ray system. ▪ Green 16 (PHT-65LHS) system is designed to withstand the effects of defibrillation. However, disconnect the Dental X-ray system during defibrillation since a malfunction of the safety controls could otherwise result in electrical burns for the patient.
 CAUTION	<ul style="list-style-type: none"> ▪ Federal law restricts this device to sale by or on the order of a dentist or with the descriptive designation of any other practitioner licensed by the law of the State in which he practices using or order the use of the device.

Lasers

- The system incorporates Class 1 laser products. The light localizers used in this product are intended for correct patient positioning and must not be used for any other purpose.
- Advise the patient not to look directly at the laser beam for safety.
- While adjusting the patient, ensure that the laser beam is not directed at the patient's eyes.
- Wavelength: 650 nm, Radiant power: Max. 039 mW



Risk of eye injury!

Do not use this equipment with any other laser sources, and do not make any changes to the settings or processes described in these operating instructions.

Cleaning

- Never expose this equipment to liquids, mists, or sprays. Exposing this equipment to liquids may cause an electric shock or otherwise damage the system.
- Do not use spray cleaners on this equipment, as this could cause a fire.

During the Operation

- Never use this equipment in an environment that is susceptible to explosion.
- Do not place flammable materials near this equipment.
- Do not use the PC while the equipment is operating. Failure to comply with this instruction may result in system malfunction.
- Immediately stop imaging if the equipment malfunctions in any way.
- If a problem occurs during imaging, press the red **Emergency Stop Switch** to immediately stop all moving parts and cut off all power to the equipment's electrical components.
- Never touch the patient while he or she is touching the SIP/SOP connectors.
- The medical electrical equipment or medical electrical system should not be used adjacent to or stacked with other equipment. If adjacent or stacked use is necessary, the medical electrical equipment or medical electrical system should be observed to verify normal operation in the configuration in which it will be used.
- The use of accessories and cables other than those specified, except cables sold by **VATECH** of the medical electrical equipment or medical electrical system as replacement parts for internal components, may result in increased EMISSIONS or decreased IMMUNITY EQUIPMENT or SYSTEM.

In case of an electrical fire

- Use only fire extinguishers designed for electrical fires to extinguish fires on this equipment.
- Liquid extinguishers, such as those which use water, could damage the equipment, and cause physical injury.
- Unplug the equipment's power cable before extinguishing any fire.

Installation

- To avoid improperly balanced equipment, install the device on a flat surface to maintain stability.
- If the equipment is not stable, property damage and personal injury may occur.
- Do not push or pull the equipment.
- An authorized technician must install equipment, complying with proper installation procedures.

NOTICE

For further details on installation, refer to the **Green 16 (PHT-65LHS) Installation Manual**.

Security Capabilities

- It is recommended to install and operate **EzDent-i** under a secure operating environment that allows only authorized users to access and a system network equipped with Windows built-in firewall, Windows Defender antispysware tools, and other commonly used 3rd party security tools and application systems.
- It is recommended to update the latest version of anti-virus software and firewall.
- The software can be updated by the manufacturer only. Unauthorized software update through a third party, not the manufacturer, is strictly prohibited. Please contact the manufacturer for cybersecurity issues related to the software and medical devices.

3.4.1 Side Effects

- X-ray imaging exam should be performed only after carefully considering the patient's health needs. The operator must understand the well-known risks which can occur during the X-ray exposure and minimize them by preventing unnecessary radiation exposure for patients.

4. Imaging System Overview

4.1 System Components

- **Green 16 (PHT-65LHS)** X-ray equipment
- PC system
- Console Software: PANO, CEPH (Optional), CBCT, and 3D MODEL Scan
- **EzDent-i**: 2D viewer and patient management software
- **Ez3D-i**: 3D viewer software

4.2 Features

- Multi-FOV support: Selectable FOV among 16x9, 12x9, 8x9, 8x5 and 5x5 (cm)
- The multi-imaging solution for Accurate Diagnostics
- Conventional 2D (PANO and CEPH) image acquisition
- 3D scanning for Plaster Cast with FOV 8x9 (cm)
- Touch Screen implemented for easy use
- DICOM (Digital Imaging Communication in Medicine) format supported

4.3 Imaging System Overview



Configuration	Item	Sensor	
SP	PANO +CBCT	PANO / CBCT	Xmaru1314CF
SC	PANO + CBCT + CEPH	PANO / CBCT	Xmaru1314CF
		CEPH	Xmaru2602CF

4.4 Standards and Regulations

Standards

Green 16 (PHT-65LHS) is designed and developed to comply with the following international standards and regulations:

- MEDICAL - APPLIED ELECTROMAGNETIC RADIATION EQUIPMENT AS TO ELECTRICAL SHOCK, FIRE, AND MECHANICAL HAZARDS, ONLY IN ACCORDANCE WITH
ANSI/AAMI ES60601-1 (2005) + AMD 1 (2012),
CAN/CSA-C22.2 No. 60601-1 (2014), IEC 60601-1-3 (2008), IEC 60601-2-63 (2012)
- 21 CFR 1020.30, 31, 33
- NEMA Standard publication PS 3.1-3.18, 2008

	<p>This is Class IIb equipment and obtained CE marking in April 2007 for regulations compliance following the revised European Union's MDD (Medical Devices Directive) 93/42 EEC.</p>
	<p>MEDICAL - APPLIED ELECTROMAGNETIC RADIATION EQUIPMENT AS TO ELECTRICAL SHOCK, FIRE, AND MECHANICAL HAZARDS ONLY IN ACCORDANCE WITH ANSI/AAMI ES60601-1 (2005) + AMD 1 (2012), CAN/CSA-C22.2 No. 60601-1 (2014), IEC 60601-1-3 (2008), IEC 60601-2-63 (2012)</p>

Classifications (IEC 60601-1 6.1)

- The degree of protection against water ingress: Ordinary Equipment: IPX0
- The degree of protection against electric shock: Class 1 equipment, Type B
Applied parts: temple supports, chinrests, bites and covers, ear rods and caps, and carpus plate



4.5 Operating Principles

X-ray is emitted when a high voltage is supplied to the X-ray tube assembly, freeing electrons from the cathode.

They hit anode to produce an X-ray. The machine acquires images by emitting X-rays continuously and rotates on the human tooth at different angles.

Images are acquired, computed, and recompiled to reproduce 2D or 3D images.

4.6 Imaging System Configuration

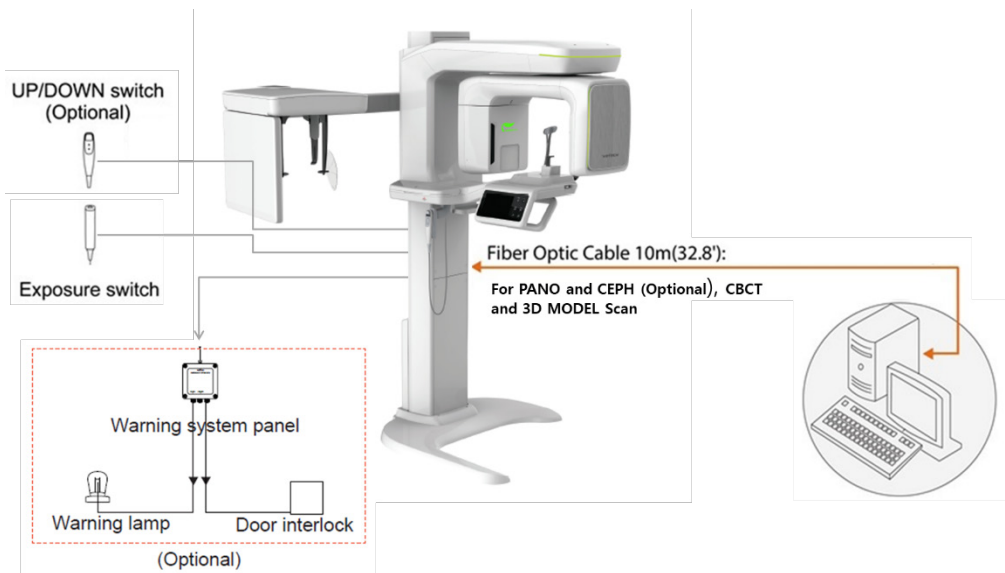

PC Signal Input / Output

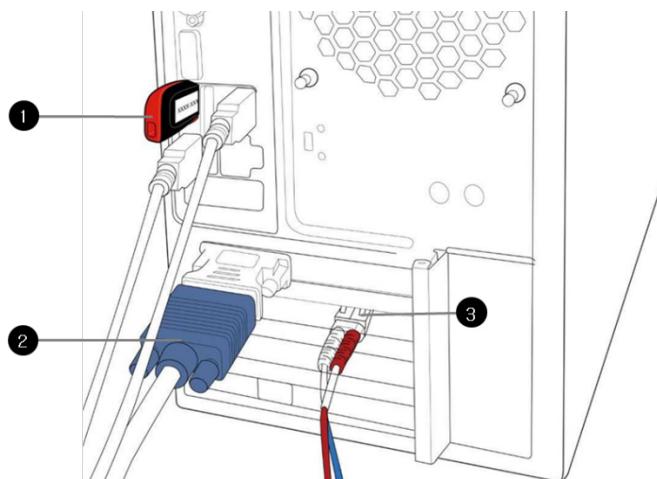

No.	Item
1	3D viewer License Key
2	Video output
3	Fiber optic cable (for data in / out)

4.7 Equipment Overview

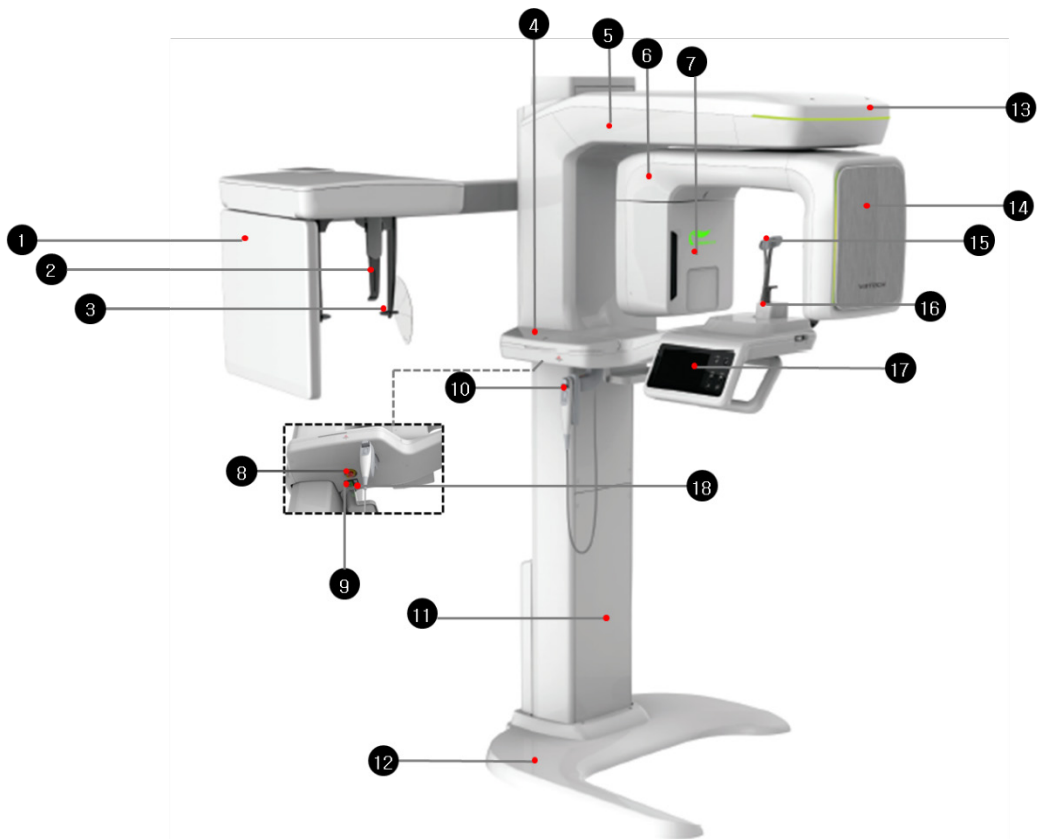

No.	Item	Description
1	X-ray Detector for CEPH (Optional)	Xmaru2602CF for CEPH imaging sensor
2	Nasal Positioner	Assists patient positioning for CEPH imaging.
3	Ear Rods	Secure the patient's head during CEPH imaging.
4	Enclosed Component Storage	Stores Bites, Chinrest Assembly, and the other components.
5	Vertical Frame	Holds the Rotating Unit. You can control the vertical frame with the Column UP/DOWN switch.
6	Rotating Unit	Rotates around the patient's head while the image is being acquired. (Its movement varies based on the scan mode)
7	X-ray Generator	Produces X-ray from the vacuum tube.
8	Emergency Stop Switch	Immediately stops the moving parts and cuts off all power to the equipment's electrical components.

4. Imaging System Overview

No.	Item	Description
9	Main Power Switch	Turns on / off the main power of the equipment.
10	Column UP/DOWN Switch (Optional)	Adjusts the height of the Vertical Frame.
11	Stationary Column	Supports the whole part of the equipment.
12	Base (Optional)	Balances the equipment and maintains its safety.
13	LED Lamp	Displays the status of X-ray exposure. - Green: Standby - Yellow: In operation
14	X-ray Detector for PANO / CBCT	Xmaru1314CF for PANO / CBCT imaging sensor
15	Temple Supports	Supports the patient's head by holding the temples. It is used in PANO and CBCT modes.
16	Chinrest	A place to rest the chin
17	Control Panel (LCD type)	<p>Operates the Horizontal Beam, opens/closes Temple Supports, adjusts the height of the Vertical Frame, and prepares for operation when the READY button is pressed. (For the details, refer to 4.7.1 Control Panel.)</p> 
18	D-Sub Connector	The input signal port for Column UP/Down Switch

4.7.1 Control Panel

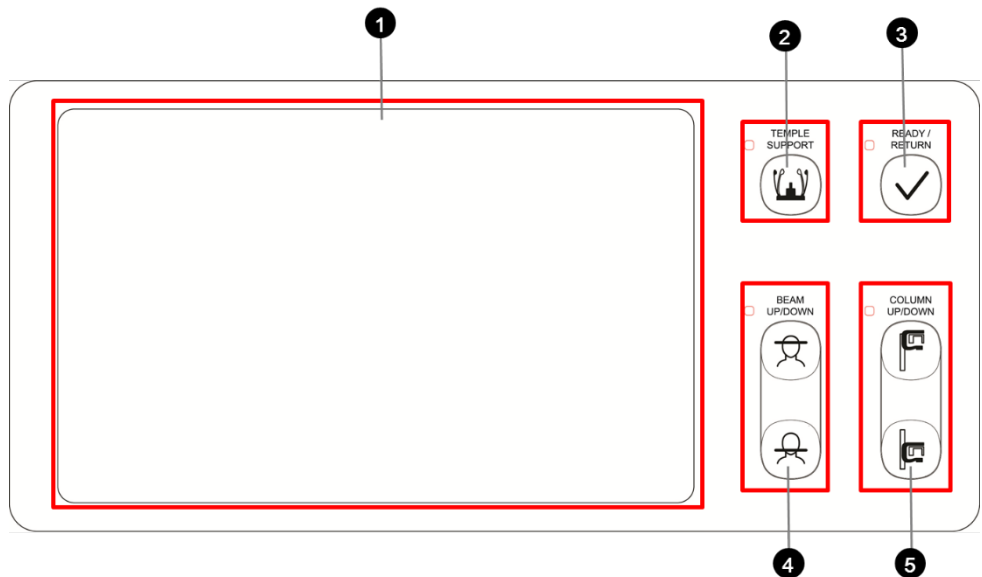

No.	Buttons	Description
1	Touch Screen (LCD)	Configures the parameter settings in each imaging mode. For more information, refer to the 4.7.2 Touch Screen .
2	TEMPLE SUPPORT Open/Close Button	Adjusts the Temple Supports for patient positioning.
3	READY / RETURN Button	Indicates that imaging is ready after parameter settings and the patient positioning is complete. Initializes the positioning of the Rotating Unit.
4	Horizontal BEAM UP/DOWN Button	Aligns the Horizontal Beam in PANO mode.
5	COLUMN UP/DOWN Button	Moves the Vertical Frame up or down. (For adjusting the height of the Chinrest)

4.7.2 Touch Screen

The touch screen is provided to set options for each imaging mode. The screen is connected to the console software and provides the same functions as the software (See **5.3 Console Software**). Only users can turn on and change the settings of the touch screen.

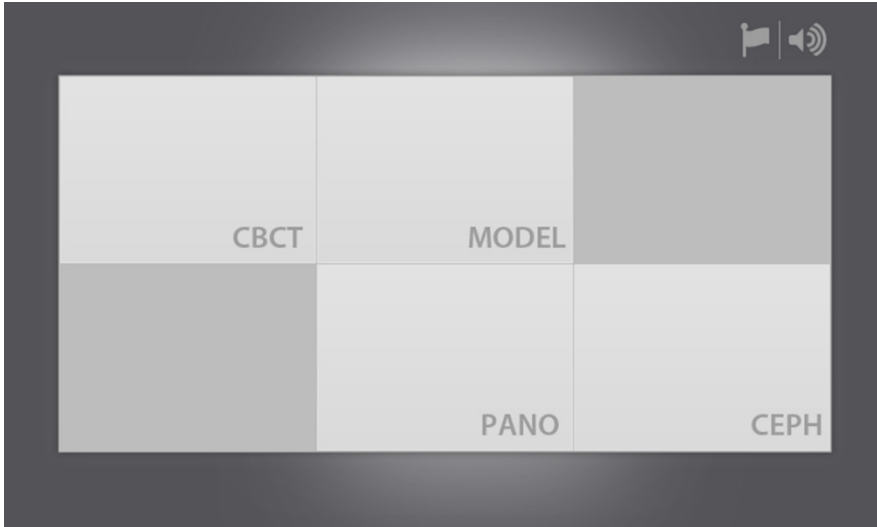

Modality Selection Screen

⚠ CAUTION

- Do not use a pointed object such as a pen to touch the screen panel. Pressing the screen with an object other than fingers can damage the screen.
- Do not press the touch screen hard when you are selecting options. Pressing hard can cause cracks and other damage to the screen.
- Never allow the patients to change settings on the touch screen to avoid physical injuries or damage to the equipment.

NOTICE

“CEPH” is visible on the modality selection screen only when your equipment has the CEPH option.

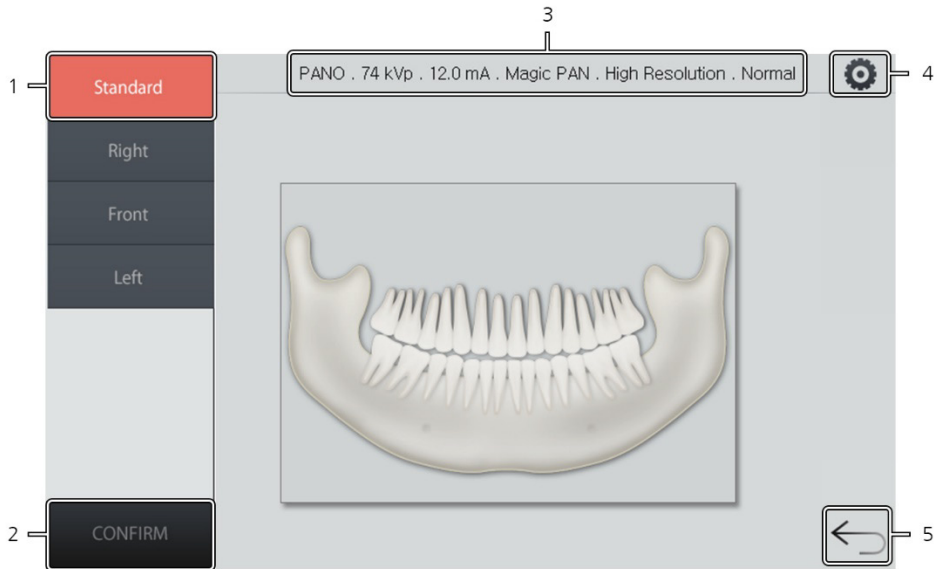
PANO Main Screen**PANO Main Screen**

No.	Function	Description
1	Examination Mode Selection	Selects a PANO examination mode.
2	CONFIRM Button	Confirms the setting you chose and moves to the next step.
3	Imaging Parameter Setting Information	Displays the current PANO setting information.
4	Settings Button	Changes in the imaging parameters include: <ul style="list-style-type: none"> ▪ Tube voltage ▪ Tube current ▪ Patient's gender and age ▪ X-ray intensity ▪ Examination type ▪ Imaging type ▪ Arch type ▪ Image option
5	Back Button	Returns to the modality selection screen.

PANO Settings Screen

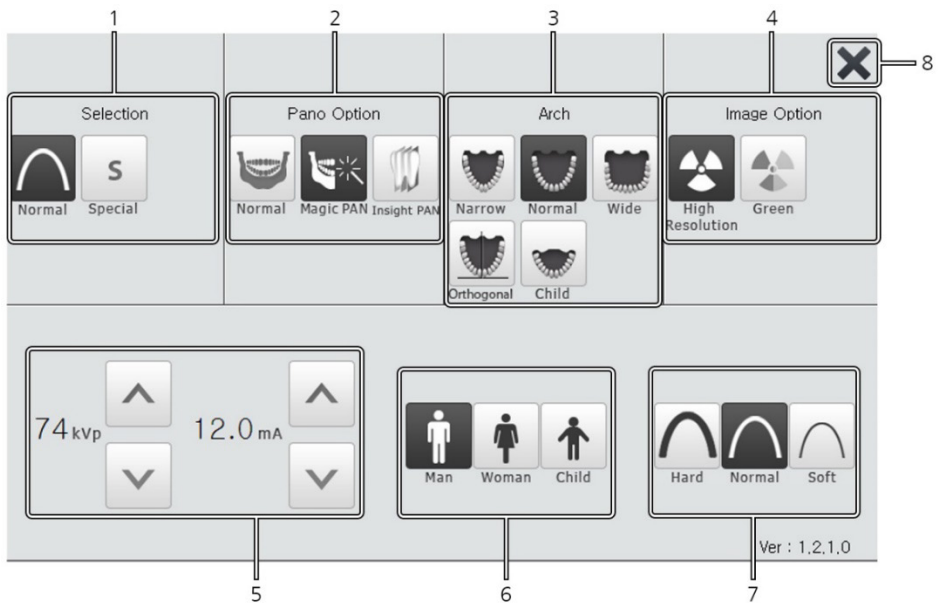

PANO Settings Screen

No.	Function	Description
1	Selection	Selects an examination program.
2	Pano Option	Selects a PANO option.
3	Arch	Selects an arch type that matches with patient's arch shape.
4	Image Option	Selects an image quality. (Image quality: High Resolution > Green)
5	kVp / mA Control Button	Changes tube voltage (kVp) and current (mA) values.
6	Gender / Age Option	Selects a gender and age for your patient. For age selection, follow the guidelines below: <ul style="list-style-type: none"> ▪ Child: 2~12 years of age ▪ Adult: Above 12 years of age
7	X-ray Intensity	Selects one of the X-ray intensities according to the patient's head circumference: <ul style="list-style-type: none"> ▪ Soft ▪ Normal ▪ Hard
8	EXIT Button	Closes the settings page and returns to PANO main screen.

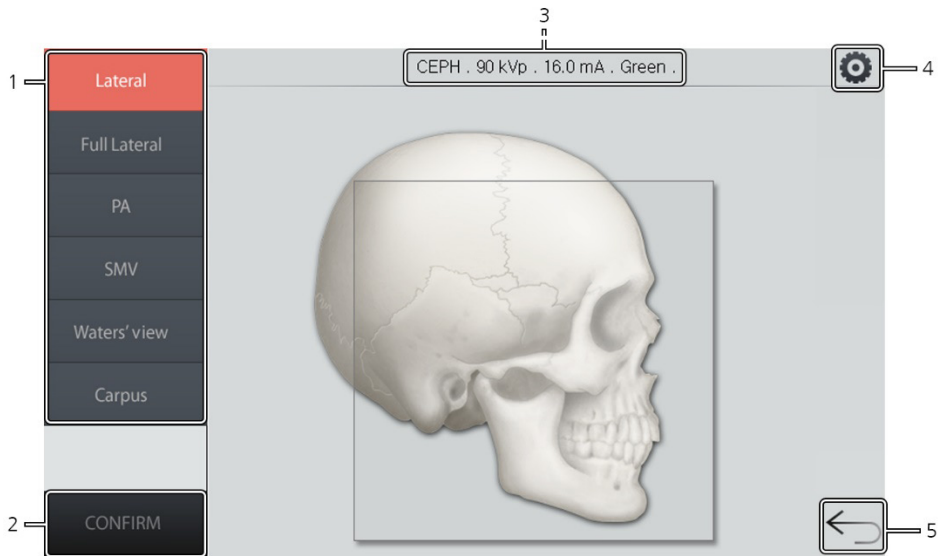
CEPH Main Screen**CEPH Main Screen**

No.	Function	Description
1	Examination Mode Selection	Selects a CEPH examination mode.
2	CONFIRM Button	Confirms the setting you chose and moves to the next step.
3	Imaging Parameter Information	Displays the current setting information.
4	Settings Button	Changes the imaging parameters, including: <ul style="list-style-type: none"> ▪ Tube voltage ▪ Tube current ▪ Patient's gender and age ▪ X-ray intensity ▪ Image option
5	Back Button	Returns to the modality selection screen.

CEPH Settings Screen

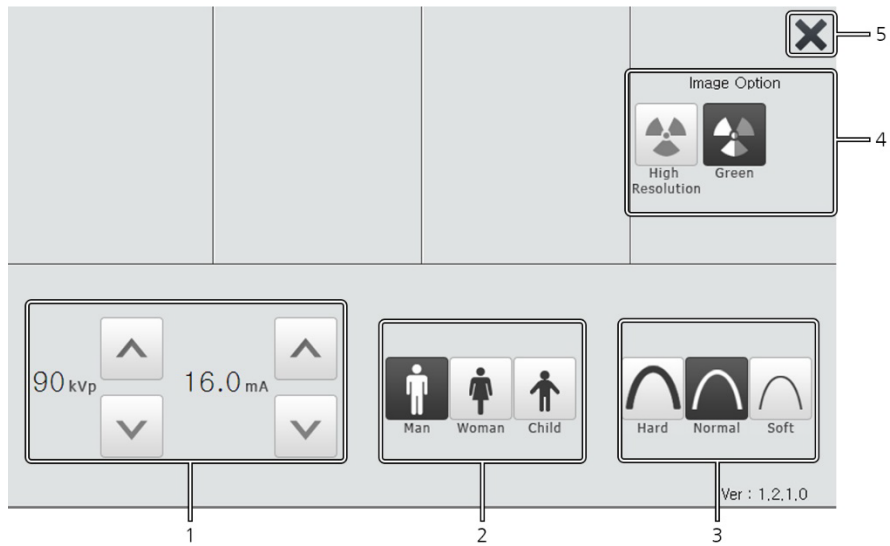

CEPH Settings Screen

No.	Function	Description
1	kVp / mA Control Button	Adjusts tube voltage (kVp) and current (mA).
2	Gender / Age Option	Selects the patient's gender and age. For age selection, follow the guidelines below: <ul style="list-style-type: none"> ▪ Child: 2~12 years of age ▪ Adult: Above 12 years of age
3	X-ray Intensity	Selects different X-ray intensities according to the circumference of the patient's head: <ul style="list-style-type: none"> ▪ Soft ▪ Normal ▪ Hard
4	Image Option	Selects an image quality. (Image quality: High Resolution > Green)
5	Exit Button	Closes the settings page and returns to CEPH main screen.

CBCT Main Screen

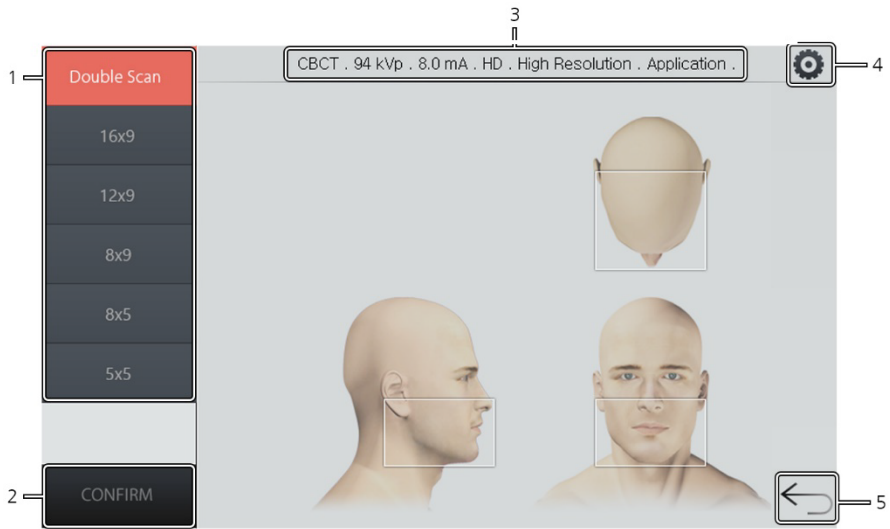

CBCT Main Screen

No.	Function	Description
1	FOV Selection	Selects a FOV for CBCT imaging.
2	CONFIRM Button	Confirms the settings you chose and moves to the next step.
3	Imaging Parameter Information	Displays the current CBCT setting information.
4	Settings Button	Allows you to change the imaging parameters, including: <ul style="list-style-type: none"> ▪ Tube voltage ▪ Tube current ▪ Patient's gender and age ▪ X-ray intensity ▪ Image option ▪ Voxel Size
5	Back Button	Returns to the modality selection screen

CBCT Settings Screen

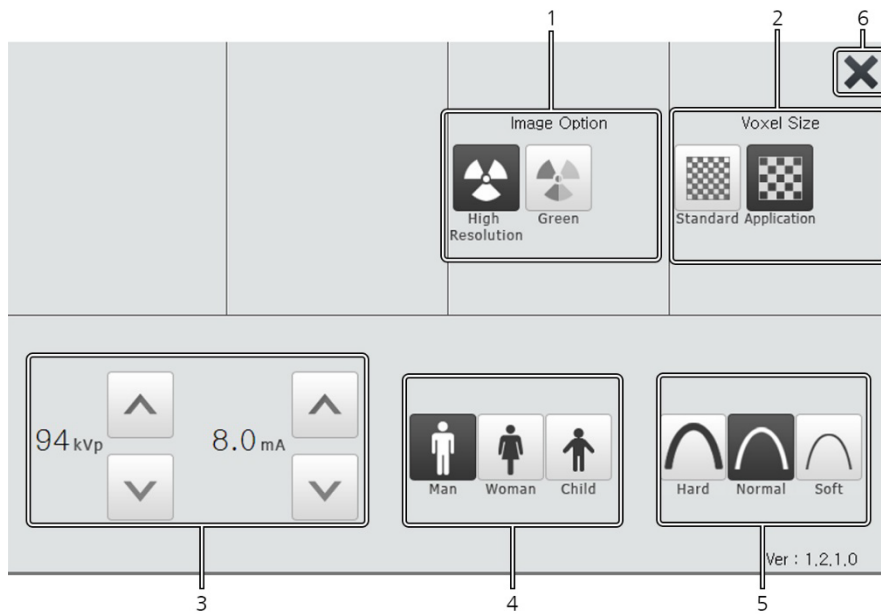

CBCT Settings Screen

No.	Function	Description
1	Image Option	Selects an image quality. (Image quality: High Resolution > Green) Note: The image options menus become invisible on the touch screen when you disable Green on the console software.
2	Voxel Size	Selects a voxel size for the image.
3	kVp / mA Control Button	Adjusts tube voltage (kVp) and Tube current (mA).
4	Gender / Age Option	Selects a gender and age for your patient. For age selection, follow the guidelines below: <ul style="list-style-type: none"> ▪ Child: 2~12 years of age ▪ Adult: Above 12 years of age
5	X-ray Intensity	Selects different X-ray intensities according to the circumference of the patient's head: <ul style="list-style-type: none"> ▪ Soft ▪ Normal ▪ Hard
6	Exit Button	Closes the settings screen and returns to CBCT main screen.

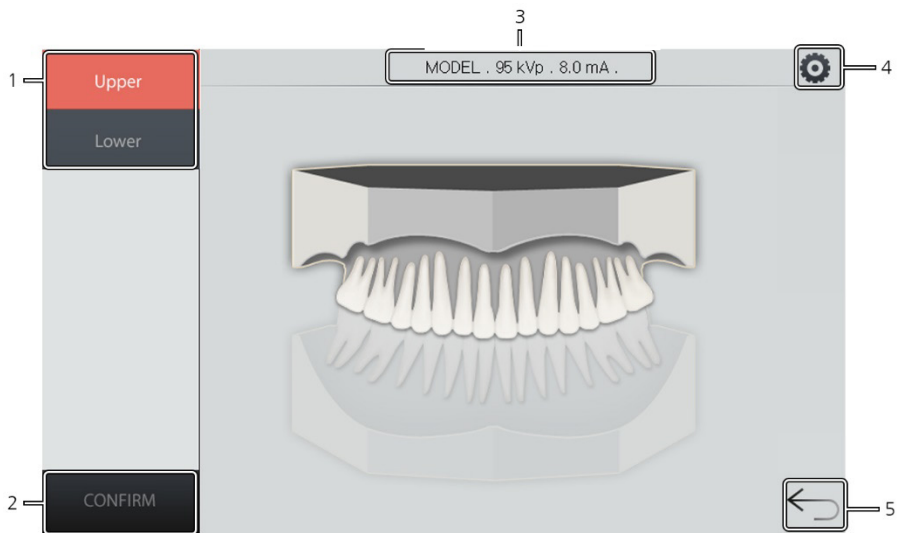
3D MODEL Scan Main Screen**3D Model Scan Main Screen**

No.	Function	Description
1	Examination Mode Selection	Selects a 3D model scan examination mode.
2	CONFIRM Button	Confirms the settings you selected and moves to the next step.
3	Imaging Parameter Information	Displays the current setting information.
4	Settings Button	Allows you to change the imaging parameters, including: <ul style="list-style-type: none"> ▪ Tube voltage ▪ Tube current ▪ Patient's gender and age ▪ X-ray intensity
5	BACK Button	Returns to the modality selection screen.

3D MODEL Scan Settings Screen

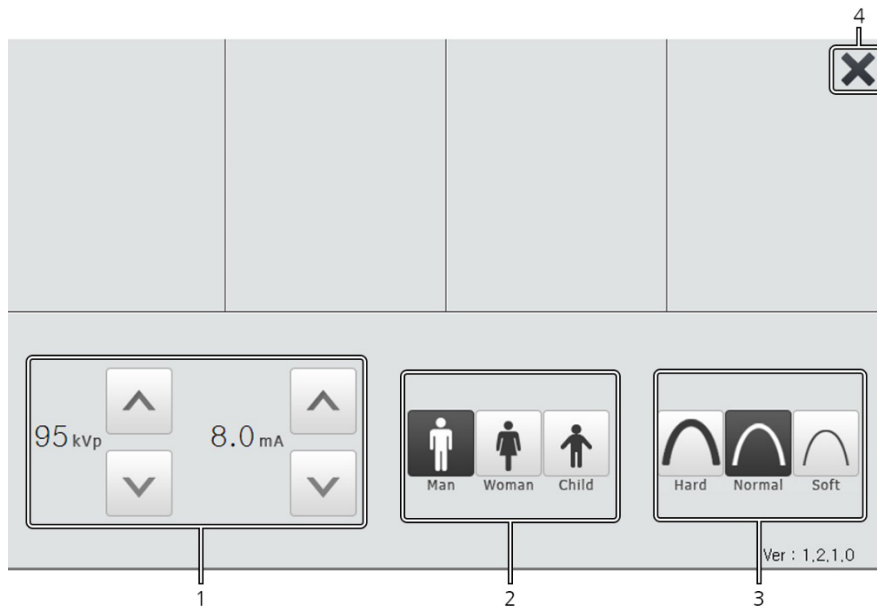

3D Model Scan Settings Screen

No.	Function	Description
1	kVp / mA Control Button	Adjusts tube voltage (kVp) and Tube current (mA).
2	Gender / Age Option	Selects a gender and age for your patient. For age selection, follow the guidelines below: <ul style="list-style-type: none"> ▪ Child: 2~12 years of age ▪ Adult: Above 12 years of age
3	X-ray Intensity	Selects different X-ray intensities according to the circumference of the patient's head: <ul style="list-style-type: none"> ▪ Soft ▪ Normal ▪ Hard
4	EXIT Button	Closes the settings screen and moves back to the 3D model scan main screen.

4.7.3 Emergency Stop Switch

Press the **Emergency Stop Switch** to stop the equipment in an emergency. The switch is located under the handle frame. As you press the switch, the equipment will stop.

After the problem is resolved, turn the switch until it pops up to restart the system.

An emergency may include the following situations but is not limited to:

- Continuing X-ray emission (when the exposure switch is not pressed)
- Physical injuries of the patient
- Damages to the equipment and other properties.



4.7.4 Exposure Switch

The **Exposure Switch** allows the operator to control image acquisition outside the X-ray room.

Press and hold the **Exposure Switch** down until the acquisition is complete. Premature release of the **Exposure Switch** will abort image acquisition.

Pressing the **Exposure Switch** activates the LED indicator to turn yellow. This color indicates that the X-ray is being emitted.













IMPORTANT





- The **Exposure Switch** is detachable. Ensure that the **Exposure Switch** cable is not detached from the unit accidentally during operation.
- Keep vocal/visual contact with the patient during exposure. If any problem occurs during exposure, release the **Exposure Switch** immediately.

4.7.5 Enclosed Components

The enclosed components listed below can be detached from the equipment. The components that come to touch with the patient, such as bite blocks and chinrest, must be cleaned with non-alcoholic chlorine dioxide-based disinfectant for each use.

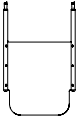
Components	Name and Function	Materials
	Normal Bite - For PANO and CBCT, normal patients	PC (Polycarbonate)
	Deep Bite Block*	PC (Polycarbonate)
	Special Bite A - For PANO TMJ and Sinus modes - For CBCT TMJ patients	PC (Polycarbonate)
	Special Bite B - For PANO edentulous patients - For CBCT Double scan (Mandible) mode.	PC (Polycarbonate)
	Double Scan Support - For CBCT Double scan (Maxilla) mode.	PC (Polycarbonate)
	Normal Chinrest - For Normal Bite - For CBCT Double scan (Mandible) mode.	ABS (Acrylonitrile butadiene styrene) copolymer
	Special Chinrest - For Special Bite A and Special Bite B	ABS (Acrylonitrile butadiene styrene) copolymer
	Temple Supports (1 set)	PC (Polycarbonate)
	Ear Rods (1 set)	Silicone
	Nasal Positioner Cover - For CEPH	Silicone

4. Imaging System Overview

Components	Name and Function	Materials
	Carpus Plate	PC (Polycarbonate)
	Sanitary Vinyl Covers (disposable) for the Bite Block	PP+PE
	Sanitary Vinyl Covers (disposable) for the Double Scan Support	LDPE (Low-density polyethylene)
	Protractor (1 set) - For positioning the patient's body in CEPH mode.	PC (Polycarbonate)
	Model Scan Jig	ABS (Acrylonitrile butadiene styrene) copolymer

This Page Intentionally Left blank

5. Imaging Software Overview

Three programs are included in this equipment to acquire, process, and view the image:

- **EzDent-i:** 2D viewer and patient management software
- **Ez3D-i:** 3D viewer software
- Console software: PANO, CEPH (Optional), CBCT, and 3D MODEL Scan

5.1 PC Specifications (Recommended)

NOTICE

- The PC system plays an important role in image processing and verification. Configure the PC environment to meet the following specifications, or the image quality can be lowered.
- Do not place patients near the equipment and PC.

Item	Specifications
CPU	Intel Xeon W-2223 3.6 GHz 4 Core Processor
RAM	16GB DDR4-2133 Registered RAM or larger
HDD	1TB SATA
Graphics board	NVIDIA GeForce GTX1060 D5 6GB or greater
Ethernet Interface	Integrated Intel I218LM PCIe GbE
Serial Port (RS232)	HP Serial Port Adapter kit
Power Supply	≥ 700 Watts (90% efficient)
Slots	2 PCI Express Gen3 x16 slot 1 PCI Express Gen3 x 8 Slot 1 PCI Express Gen2 x 4 Slot 1 PCI Express Gen2 x 1 Slot 1 PCI Slot
CD/DVD drive	DVD-ROM, DVD+/-RW, Blu-Ray
Monitor	19" 1280x1024 screen resolution
Operating System	Windows 10
Recommended System	HP Z4

5.2 EzDent-i

EzDent-i is dental imaging software from **VATECH Co., Ltd.** manages patient images to make faster and more accurate diagnoses. **EzDent-i**, linked with the console software and 3D viewer, makes it convenient for the operator to use and process necessary images. Various functions enable the acquired images to be processed quickly and conveniently from the console software.

NOTICE

Please refer to **6.2.1 Creating a New Patient Record**, **6.2.2 Retrieving Patient Records**, and **EzDent-i User Manual**.

NOTICE

Security Capabilities

- It is recommended to install and operate **EzDent-i** SW within a secure environment that allows only authorized users to access and a system network equipped with Windows built-in firewall, Windows Defender antispymware tools, and other commonly used 3rd party security tools and application systems.
- It is recommended to update the latest version of anti-virus software and firewall.
- The software can be updated by the manufacturer only. Unauthorized software update through a third party, not the manufacturer, is strictly prohibited. Please contact the manufacturer for cyber security issues related to the software and medical devices.

5.3 Console Software

Use the console software to select options for imaging. You can also use a touch screen to select and change imaging options.

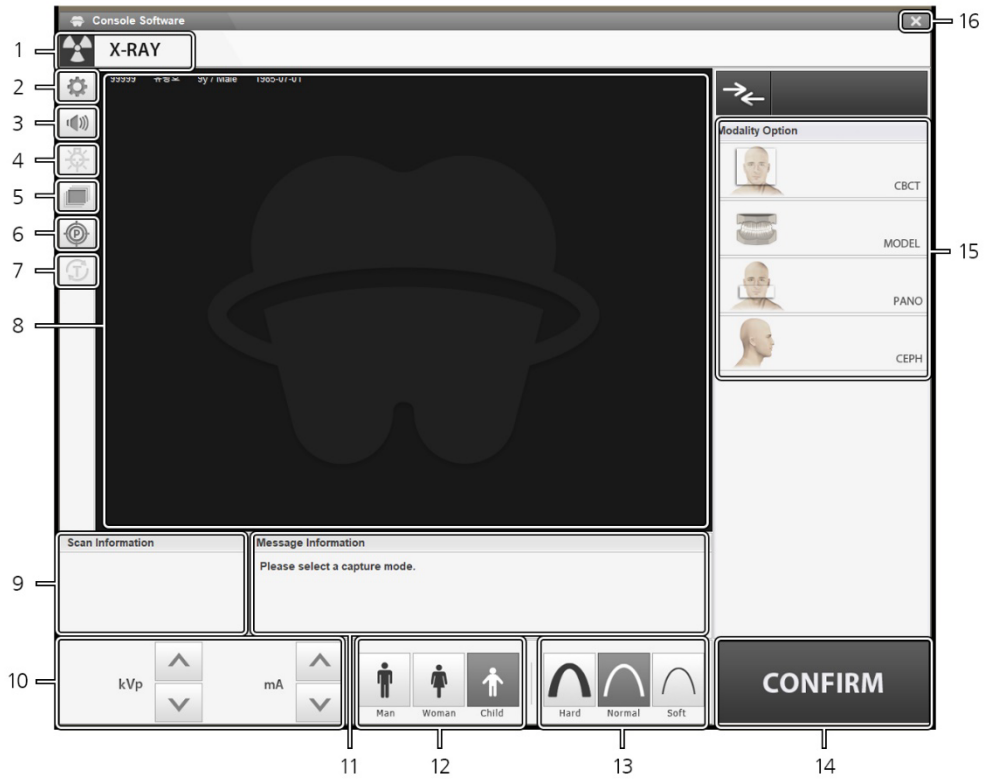

NOTICE

Due to product enhancement, the console software can be updated without notice.



Console Software's Main Window

No.	Item	Description
1	X-ray Indicator	<p>Indicates X-ray exposure status by changing the indicator's color and message.</p> <ul style="list-style-type: none"> ▪ Grey and "X-RAY": X-ray is turned off ▪ Yellow and "X-RAY ON": X-ray is turned on 
2	Settings Button	<p>Sets various equipment-related parameters, including:</p> <ul style="list-style-type: none"> ▪ Language ▪ Automatic Save on/off ▪ DAP display unit
3	Volume Button	<p>Changes the volume of the audio message. Ensure to save your change each time you reset the volume.</p>
4	Laser Beam ON/OFF Button	<p>Turns the laser beam on or off for patient positioning. This button appears after you click the CONFIRM button.</p>
5	Manual Reconstruction Button	<p>Reconstructs the captured image manually when the system fails to run automatic image reconstruction. Follow the instructions below for manual reconstruction:</p> <ol style="list-style-type: none"> (1) Click a manual reconstruction. (2) Select a modality. (3) Click Search. (4) Select an image for reconstruction. (5) Click Reconstruction.
6	Phantom Button	<p>Switches the system for the phantom image acquisition using a phantom jig.</p>
7	Test Rotation Button	<p>Sets the system for a rotation test, which checks if the rotating unit hits the patient's body before actual imaging.</p> <p>To run a rotation test, follow the procedure below:</p> <ol style="list-style-type: none"> (1) Ask the patient to position the equipment. (2) Select a modality. (3) Click the Confirm button. (4) Click the Test Rotation Button. Then "ON" on the button is changed into "OFF." (5) Press the Laser Beam ON/OFF button on the control panel. (6) To finish the test mode, click the Test Rotation button or the READY button.

8	Patient Information Window	Displays the information of a selected patient.										
9	Scan Information Window	Displays estimated DAP (Dose Area Product), scan time, and exposure time after you set up X-ray exposure parameters.										
10	Tube Voltage and Current Buttons	Changes tube voltage (kVp) and current (mA) values. Click arrows to modify the voltage and current originally set by the system.										
11	Guide Message Window	Displays text instructions during the operation.										
12	Patient's Gender/Age Group	<p>Displays the current patient's gender/age group as entered in EzDent-i's patient information fields. If necessary, the gender/age group can be selected manually.</p> <table border="1"> <thead> <tr> <th colspan="2">Gender / Age Group</th> <th>VATECH's Standard</th> </tr> </thead> <tbody> <tr> <td colspan="2">Child</td> <td>2 ~ 12 years of age</td> </tr> <tr> <td rowspan="2">Adult</td> <td>Man</td> <td rowspan="2">> 12 years of age</td> </tr> <tr> <td>Woman</td> </tr> </tbody> </table>	Gender / Age Group		VATECH's Standard	Child		2 ~ 12 years of age	Adult	Man	> 12 years of age	Woman
Gender / Age Group		VATECH's Standard										
Child		2 ~ 12 years of age										
Adult	Man	> 12 years of age										
	Woman											
13	X-ray Intensity	Selects X-ray intensity.										
14	CONFIRM / Ready Button	<p></p> <p>Applies selected options and turns into the Ready button.</p> <p></p> <p>The Ready button appears after you click CONFIRM button. When you click the button, the system becomes ready for image acquisition.</p>										
15	Modality Selection Button	Selects the imaging parameters for each mode: PANO, CEPH (Optional), CBCT, and 3D MODEL Scan.										
16	Exit Button	Leaves the console software.										

This Page Intentionally Left blank

6. Getting Started

6.1 Turning on the Equipment



WARNING

- Do not place the patient close to the equipment when it's being turned on. Doing so may cause physical injury to the patient and damage to the equipment.
- Do not use the PC while the equipment is in operation. Doing so may cause an error in the equipment.



CAUTION

- Do not turn the equipment on until the X-ray room reaches room temperature. The extreme change in temperature may lead to condensation inside the equipment.
- After turning it off, wait for approx. 20 seconds before rebooting it.
- Warm up the equipment for at least 5 minutes before the operation. For the best image quality, it is recommended to have a warm-up phase for more than 30 minutes.



CAUTION

If the equipment has not been used for a long time, please let it have enough time to be warmed up. It extends the life of the X-ray tube.

The imaging system mainly consists of the imaging equipment and the PC.

Before turning on the equipment, please confirm that the equipment and PC have been installed correctly.

1. Turn on the PC.
2. Press the **Main Power Switch**, which is located under the bottom of the Vertical Frame, to turn on the equipment.



NOTICE

Main Power Switch simultaneously isolates its circuits electrically from the supply mains on all poles.

3. Ensure that the green LED light at the top of the equipment is on.

6.2 Running the Image Viewer (EzDent-i)

The imaging program is interfaced with **EzDent-i**, and the user can analyze the image acquired from the Console Software easily and rapidly. On your desktop, double-click the **EzDent-i** icon. The **EzDent-i** main window will be displayed.

NOTICE

For further details on this subject, refer to the **EzDent-i User Manual**.

NOTICE

Security Capabilities

- It is recommended to install and operate **EzDent-i** SW in a secure environment that allows only authorized users to access the system and has A system network equipped with Windows built-in firewall, Windows Defender antispyware tools, and other commonly used 3rd party security tools and application systems.
- It is recommended to update the latest version of anti-virus software and firewall.
- The software can be updated by the manufacturer only. Unauthorized software update through a third party, not the manufacturer, is strictly prohibited. Please contact the manufacturer for cybersecurity issues .

NOTICE

For **Green 16 (PHT-65LHS)** dental computed tomography X-ray system, both 3D viewer (**Ez3D-i**) and Console Software are being accessed through 2D viewer (**EzDent-i**) SW. 3D viewer and Console Software do not have an image storage capacity of their own, and both programs will not be able to keep patient information.

6.2.1 Creating a New Patient Record

Follow the procedure below to create a new patient record:

The screenshot shows the EzDent-i software interface. The top navigation bar includes tabs for PATIENT, ACQUISITION, VIEWER, CONSULT, and REPORT. The main window is divided into several sections:

- SEARCH:** A search bar with a 'Search' button and a '+' icon.
- RECENT PATIENTS LIST:** Buttons for 'Recently Acquired' and 'Recently Viewed'.
- DOCTOR:** A dropdown menu currently set to 'All'.
- Patient Profile:** A card showing a patient's information:
 - Chart No.: 202191029_103203
 - Name: Koo HyunJun
 - Gender/Age: Male/47Y6M
 - Date of Birth: 1974-08-15
 - A 'More Details' button is located below the profile card.
- Patient List Table:** A table listing recent patients:

Chart No.	Name	Date of Birth
20191029_103203	Koo HyunJun	1974-08-15
20191029_103621	HyunJun Koo	1974-08-15
20191029_103722	Hyun koo	2019-01-01
202191029_103203	Koo HyunJun	1974-08-15

EzDent-i's Main Window

1. Click the **PATIENT** tab and/or from the top menu. A dialog box will appear after clicking the button.
2. In the dialog box, fill out **Chart No.** and **Name**. If necessary, fill out other areas such as social ID and mobile.
3. Click to save the new patient record.

The 'ADD PATIENT' dialog box contains the following fields and controls:

- Chart No.*:** Text input field containing '202191029_103203'.
- Name*:** Split into 'Last Name' (Koo) and 'First Name' (HyunJun).
- Gender:** Dropdown menu set to 'Male'.
- Date of Birth:** Year (1974), Month (8), and Day (15) dropdown menus.
- Doctor 1:** Dropdown menu set to 'None'.
- Doctor 2:** Dropdown menu set to 'None'.
- Social ID, Phone, Mobile, E-Mail, Zip Code, Address:** Empty text input fields.
- Buttons:** 'Add' and 'Cancel' buttons at the bottom.

NOTICE

The chart number and name are required fields. You cannot leave them as blanks.

6.2.2 Retrieving Patient Records

Follow the procedure below to retrieve the patient record saved in EzDent-i:

1. Go to the search box and enter the patient's name or chart number.

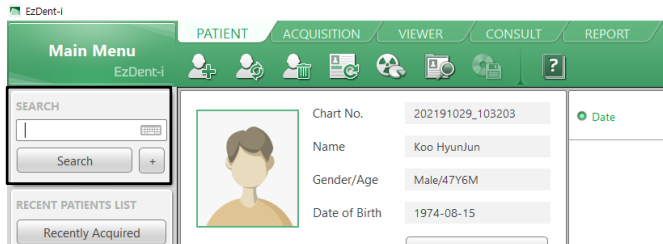

2. Click .
3. Check and double-click the patient record with the matching chart number or name.

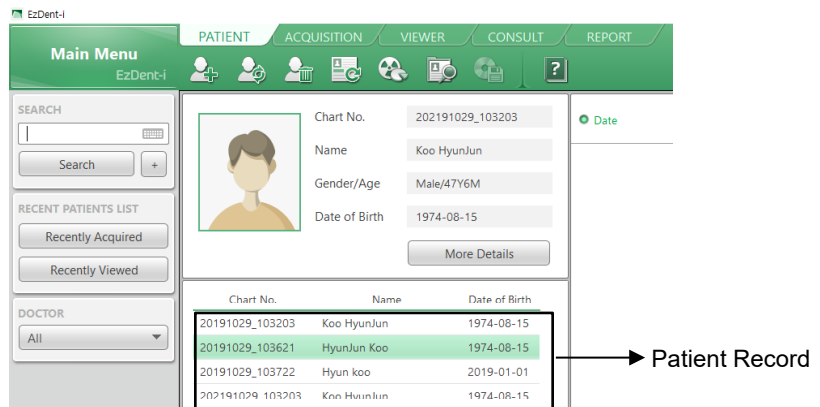

NOTICE

You can use a virtual keyboard to search for the patient record. Click the keyboard icon next to the search box if you want to use the virtual keyboard:



6.2.3 Launching the Console Software

Follow the procedure below to initiate the console software.

NOTICE

For a new patient, you must create the new patient before running the console software. Go to **6.2.1 Creating a New Patient** Information for more information.

1. Search and select the patient record.
2. Click the **ACQUISITION** tab.

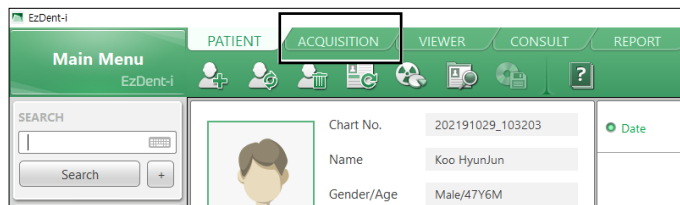

3. Select the modality you want to capture. The displayed options can be different depending on your equipment's option.

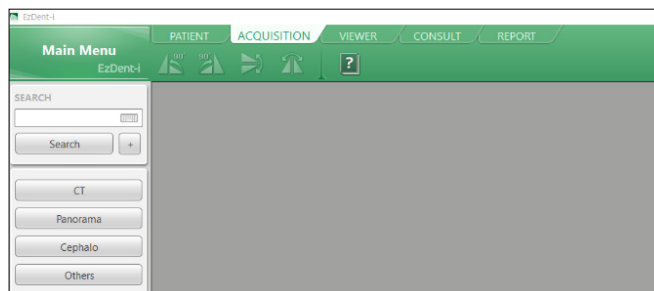

NOTICE

To set exposure parameters for each modality (CT, Panorama, Cephalo, Others), Read **chapters 7 to 10**.

7. Acquiring PANO Images

7.1 PANO Imaging Program Overview

- **Result Images**



It provides conventional 2D panoramic images.





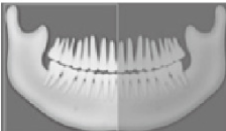

- **Image Acquisition Method**

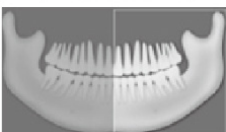
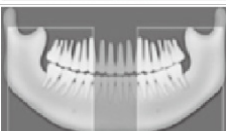
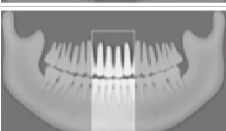
It reconstructs U-shaped arch data to a single 2D image utilizing multiple images taken with the X-ray beam scanning specific oral & maxillofacial regions at different angles.

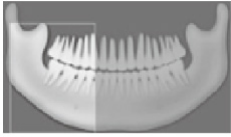
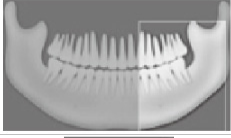
- **Examination Programs**

It is classified below based on the ROI (Region of Interest).

Examination Type	Arch Selection	ROI	Example
PANO Examination	Narrow Normal Wide Child Orthogonal	Standard	
		Right	
		Front	
		Left	
	Orthogonal	Bitewing*	
		Bitewing Incisor* (Optional)	



Examination Type	Arch Selection	ROI	Example
		Bitewing Right*	
		Bitewing Left*	
SPECIAL Examination	N/A	TMJ LAT Open	
		TMJ LAT Close	
		TMJ PA Open (Optional)	
		TMJ PA Close (Optional)	
		Sinus LAT (Optional)	
		Sinus PA	

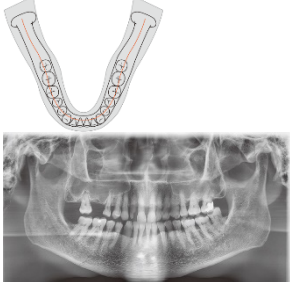
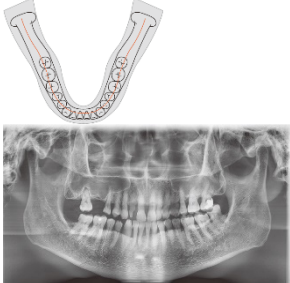
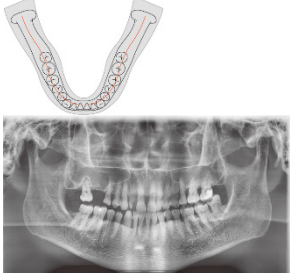

* Bitewing imaging mode is activated only when Orthogonal is selected in Arch Selection.

■ Main Imaging Programs

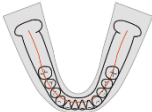
Examination Type	Arch Selection	ROI	Description & Sample Image
PANO Examination	Narrow	Standard	<p>A panoramic imaging mode for patients with a V-shaped arch trajectory. (Typically for some females)</p> 
	Normal	Standard	<p>A panoramic imaging mode for adult patients with a typical arch trajectory.</p> 
	Wide	Standard	<p>A panoramic imaging mode for the patients with a square-shaped arch trajectory. (Typically for some males)</p> 
	Child	Standard	<p>A panoramic imaging mode for child trajectory. (Less X-ray exposure than the Normal mode by approximately more than 40%)</p>

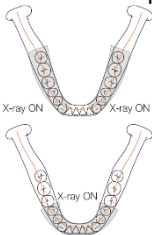
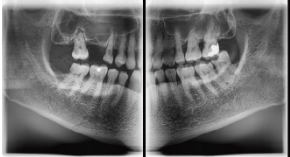
7. Acquiring PANO Images

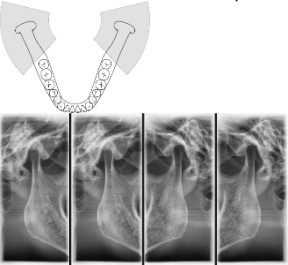
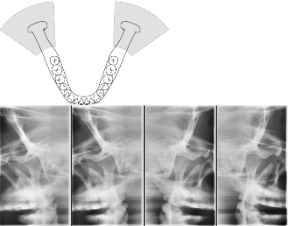
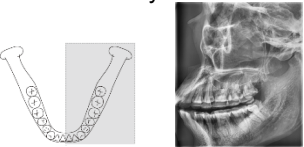
Examination Type	Arch Selection	ROI	Description & Sample Image
			 
	Orthogonal	Standard	<p>A panoramic imaging mode to minimize the overlapped region of the teeth from the X-ray exposure, which is beamed perpendicularly between teeth.</p> 
		Bitewing** (Bitewing Incisor mode is Optional)	<p>A panoramic imaging mode to acquire an image only for the region of interest through the orthogonal trajectory. (Pros: less X-ray exposure than the Normal mode. / Cons: TMJ and some parts of the maxillary sinus cannot be acquired.)</p>  
SPECIAL	N/A	TMJ LAT	An imaging mode to acquire a lateral

Examination Type	Arch Selection	ROI	Description & Sample Image
Examination		Open / Close	<p>image of the TMJ, in which the X-ray beam is directed on the lateral TMJ region. (TMJ Open and Close)</p> 
		TMJ PA Open / Close (Optional)	<p>An imaging mode to acquire a TMJ image, in which the X-ray beam is directed on the frontal TMJ, with the patient's mouth open fully and closed.</p> 
		Sinus LAT (Optional)	<p>A special imaging mode to acquire a Sinus image, in which an X-ray beam is directed on the lateral region of the maxillary sinus.</p> 
		Sinus PA	<p>A special imaging mode to acquire a Sinus image, in which an X-ray beam is directed at the frontal region of the maxillary sinus.</p> 

** Bitewing imaging mode is activated only when Orthogonal is selected in Arch Selection.

7.2 Setting Exposure Parameters

Complete the steps in **6. Getting Started** before setting the exposure parameter on the console. You can also use the touch screen to set the exposure parameters.

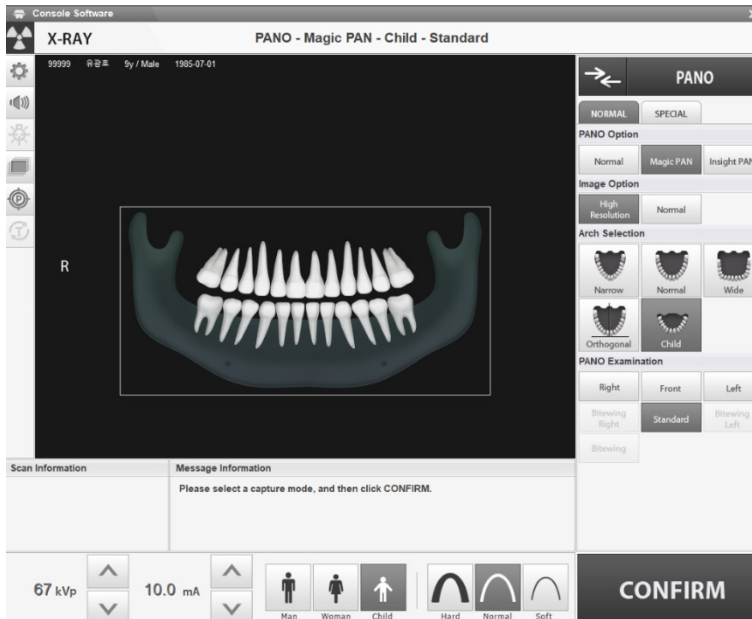

Console Software's Main Window

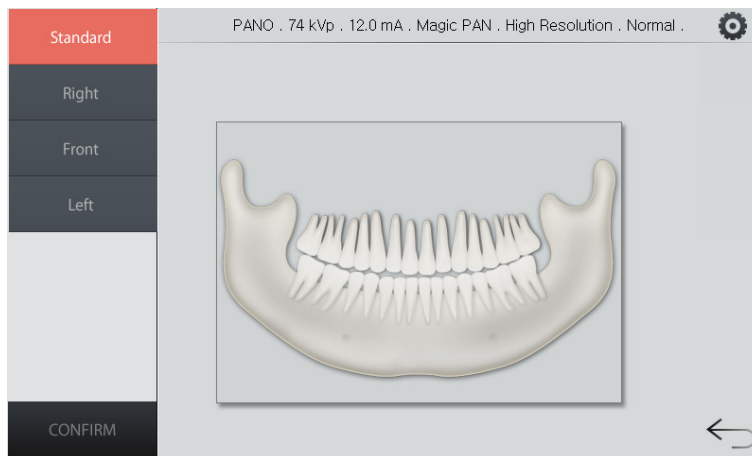

Touch Screen's Main Window

7.2.1 Setting Parameters on the Normal Tab

To set exposure parameters on the normal tab.

1. Select 'PANO' from the modality option.
2. Select the normal tab.
3. Select a PANO option: Normal, Magic Pan, Insight Pan.

Mode	Description
Normal	<ul style="list-style-type: none"> ▪ Provides a normal panoramic image.
Magic PAN (Optional)	<ul style="list-style-type: none"> ▪ Combines multiple focal images into a single optimal panoramic image. ▪ Equalizes varying image qualities caused by patient positioning and arch type and provides an enhanced panoramic image.
Insight PAN (Optional)	<ul style="list-style-type: none"> ▪ Provides multiple panoramic images with different focal planes and a normal panoramic image. ▪ Provides detailed verification of images' in-depth direction.

When you select the **Insight Pan**:

- The image options menu is disabled.
- The arch selection menu is disabled except for '**Normal**' and '**Child**.'



- The imaging area is highlighted in the guide window. You can drag or move the selected area to mark the imaging target. (Only for the console software)

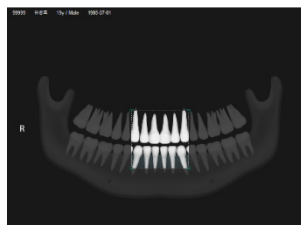

4. Select an Image Option: High Resolution or Green

7. Acquiring PANO Images

Mode	Description
High Resolution	High-Resolution image
Green	Normal quality image

- Select an arch type from the Arch Selection menu.



Arch Type	Description
Narrow	Panoramic image of V-shaped palatal arches
Normal	Panoramic image of normal adult palatal arches
Wide	Panoramic image of square-shaped palatal arches
Child	Panoramic image of child palatal arches, approximately more than 40% less X-ray dose than in Normal mode.
Orthogonal	Panoramic image where the x-ray angle enters vertically between the teeth so that overlapping images are minimized.

- Select a PANO examination option.

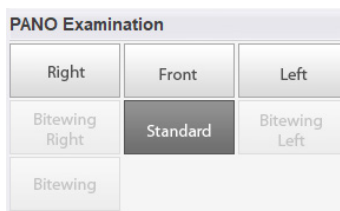

NOTICE

The patient type, X-ray intensity level, tube voltage (kVp), and current (mA) are automatically selected by the patient record you created. However, you can manually change the console software or touch screen options if necessary.

- Select the patient type from the patient selection menu.

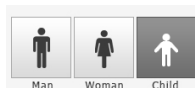

Mode		Vatech Standards
Child		2~12 years of age
Adult	Man	> 12 years of age
	Woman	

8. Select the X-ray intensity level: hard, normal, or soft.



Age	Average Head Circumference (cm)	Range (cm)	X-ray Intensity
Child	53±3	>53±3	Hard
		53±3	Normal
		<53±3	Soft
Adult	56±3	>56±3	Hard
		56±3	Normal
		<56±3	Soft

9. Click the up/down button to change the tube voltage and current values. When you click the button, the tube voltage is increased by ± 1 kVp, and the tube current by ± 1 mA.
10. Click **Confirm**. After clicking the button:
- The rotating unit moves to its initial scanning position.
 - The vertical beam activates.
 - The patient information window displays the DAP (Dose Area Product), scan time, and exposure time.

```

DAP
127.334307 mGy x cm^2

Scan-time
13.5 Sec

Exposure-time
13.5 Sec

```

7.2.2 Setting Parameters on the Special Tab

You can set exposure parameters for the special examination mode (sinus / TMJ) on the special tab.

NOTICE

You can also use the touch screen to set the exposure parameters.

NOTICE

The patient type, X-ray intensity level, tube voltage (kVp), and current (mA) are automatically selected by the patient record you created. However, you can manually change the console software or touch screen options if necessary.

Follow the procedure below to set parameters on the special tab.

1. Select the **Special** tab.
2. Select an option from the **PANO examination** menu.
3. Select the patient type: man, woman, or child.



Mode		Vatech Standards
Child		2~12 years of age
Adult	Man	> 12 years of age
	Woman	

4. Select the X-ray intensity level: hard, normal, or soft.



For the recommended X-ray intensity level, see the table below.

Age	Average Head Circumference (cm)	Range (cm)	X-ray Intensity
Child	53±3	>53±3	Hard
		53±3	Normal
		<53±3	Soft
Adult	56±3	>56±3	Hard
		56±3	Normal
		<56±3	Soft

5. Click the up/down button to change the tube voltage and current. Each time you click the button, the voltage increases by ± 1 kVp and the current by ± 0.1 mA.
6. Click the **Confirm** button.

After clicking the Confirm button:

- The rotating unit moves to its initial scanning position.
- The vertical beam activates.
- The patient information window displays the DAP (Dose Area Product), scan time, and exposure time.

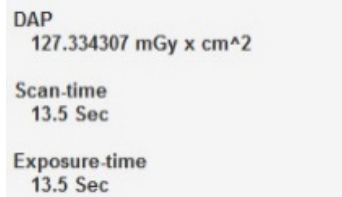

DAP
127.334307 mGy x cm²

Scan-time
13.5 Sec

Exposure-time
13.5 Sec

7.3 Patient Positioning

WARNING

- Ask the patient (especially pregnant women and children) to wear a lead apron to protect him or her from radiation exposure.
- Ensure that the laser beam does not directly enter the patient's eyes. This may lead to vision loss.

IMPORTANT

- Correct posture reduces the shadow cast by the patient's cervical spine and allows clear image acquisition.
- Metal implants or bridges can reduce the quality of the images.
- Ensure to adjust the laser beam correctly. Otherwise, the quality of images can be lowered due to ghost images or expansion/reduction of the images.

Getting prepared

- Let the patient remove all the metal objects (glasses, earrings, hairpins, braces, false teeth, etc.). Metal objects can induce ghost images and lower image quality.
- Let the patient wear a lead apron to protect themselves from residual radiation.
- Use the **Column UP/DOWN** button or switch option to adjust the equipment to match the patient's height.

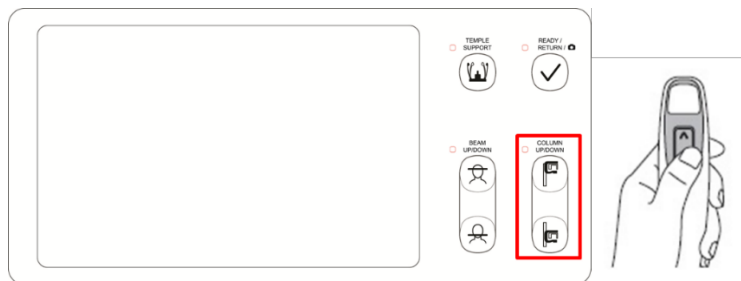

< Control Panel – LCD type >

7.3.1 PANO Examination Mode (Standard / Right / Left / Front / Orthogonal)

Normal Patient Positioning

1. Insert the **Normal Bite** into the **Normal Chinrest** and cover it with a sanitary vinyl.

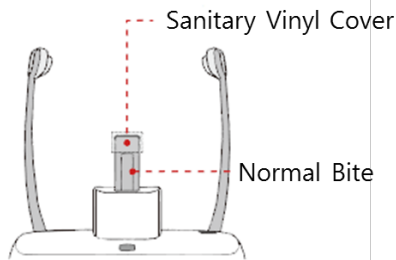

- The sanitary vinyl cover is for single use only. It should be replaced for each patient. Ensure to use the approved vinyl cover.
- Clean the chinrest and the bite with a non-alcoholic chlorine dioxide-based product and wipe with a dry towel before the next patient.

2. Use the **Temple Supports OPEN/CLOSE** button to widen the temple supports.

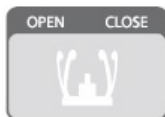

3. Guide the patient to the inside of the equipment.
4. Use the **Column UP/DOWN** button or switch option to adjust the height of the equipment so that the patient's chin reaches the Chinrest.
5. Ask the patient to stand in the center of the equipment and direct them to remain in the position outlined below.
 - Hold the handles tightly.
 - Press the chest against the equipment.
 - Keep both feet close to the inside of the base.
 - Keep both shoulders parallel.
 - Straighten the Cervical Spine and stand still.

6. Ask the patient to bite the normal bite along its grooves with his/her front teeth.

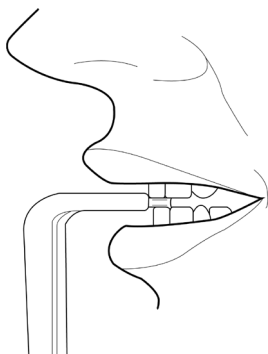

7. Ask the patient to do as follow:
 - Close the mouth.
 - Place the tongue on the roof of the mouth.
 - Close the eyes.

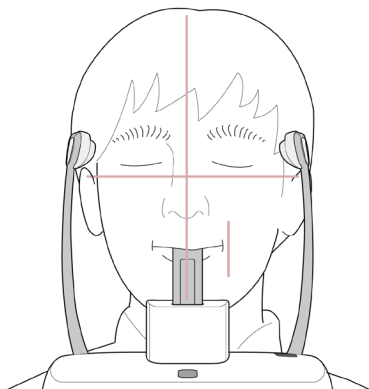

Edentulous Patient Positioning

1. Remove the **Normal Chinrest** and insert the **Special Chinrest** into the equipment.
2. Insert the Special Bite B into the Special Chinrest.

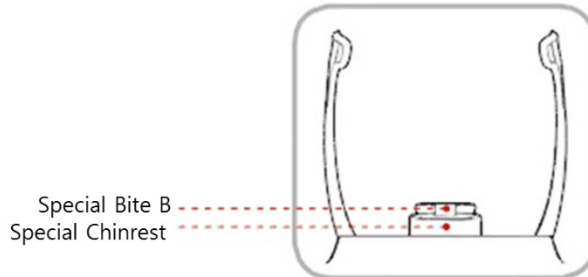

Clean the chinrest and the bite with a non-alcoholic chlorine dioxide-based product and wipe with a dry towel before the next patient.

3. Use the **Temple Supports OPEN/CLOSE** button to widen the Temple Supports.

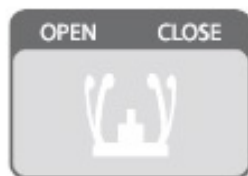



4. Guide the patient to the equipment.
5. Use the **Column UP/DOWN** button or switch option to adjust the height of the equipment so that the patient's chin reaches the Chinrest.
6. Ask the patient to stand in the center of the equipment and direct them to remain in the position outlined below.
 - Hold the handles tightly.
 - Press the chest against the equipment.
 - Keep both feet close to the inside of the base.
 - Keep both shoulders parallel.
 - Straighten the Cervical Spine and stand still.

7. Acquiring PANO Images

7. Ask the patient to maintain the posture as follows:
- Close the mouth.
 - Place the tongue on the roof of the mouth.
 - Close the eyes.



Laser Beam Alignment

 WARNING	Ensure that the laser beam does not directly enter the patient's eyes. This may lead to vision loss.
 CAUTION	Ensure to align the laser beam properly. Distortions can be found in the captured images, such as ghost shadows, if the laser beam is not correctly positioned.

1. Align the **Vertical Beam** to the center of the face (Mid-sagittal Line) to prevent the horizontal expansion of the image.
2. Use the Horizontal Beam button on the control panel to position it. Align the Horizontal Beam straight to the Frankfurt Line on the patient's face. Make sure that the Horizontal Beam is aligned to the patient's face horizontally.

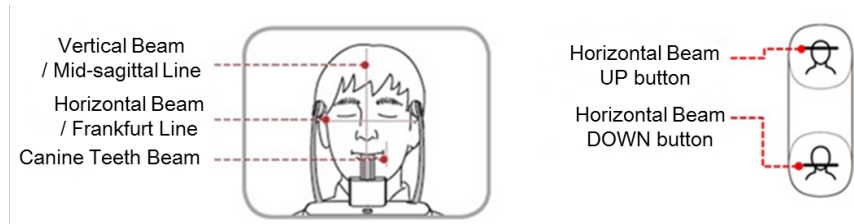

3. Direct the patient to smile and align the Canine Teeth Beam to the center of the canines. Use the Canine Teeth Beam Lever to adjust the position of the beam.

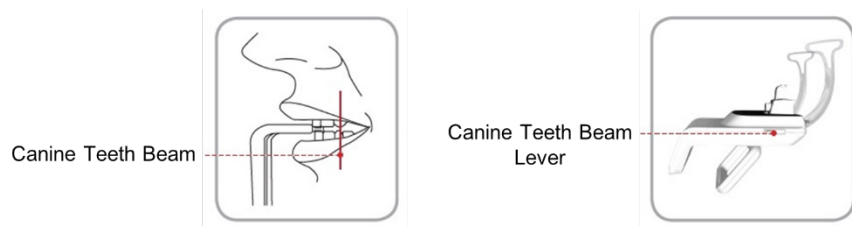

Finishing Patient Positioning

1. After checking the positions of the patient and the laser beam, click the **Temple Supports OPEN/CLOSE** button on the control panel to prevent the patient's head from moving.

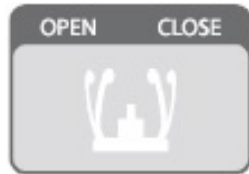

Ensure that the Temple Supports are at the **CLOSE** position before clicking the **READY** button.

2. Click the **READY** button. X-ray exposure has not started yet.
3. Go to **7.4 X-ray Exposure** to start the exposure.

7.3.2 SPECIAL Examination Mode (TMJ / Sinus)

7.3.2.1 TMJ Open (LAT / PA)

To acquire a TMJ open image, follow the procedure below:

Patient Positioning

1. Remove the **Normal Chinrest** and insert the **Special Chinrest** into the equipment.
2. Insert the Special Bite A into the Special Chinrest

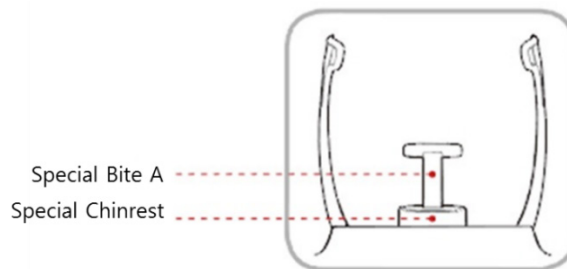

Clean the chinrest and the bite with a non-alcoholic chlorine dioxide-based product and wipe with a dry towel before the next patient.

3. Use the **Temple Supports OPEN/CLOSE** button to widen the Temple Supports.

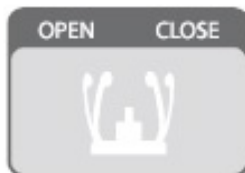

4. Guide the patient to the equipment.
5. Use the **Column UP/DOWN** button or switch option to adjust the height of the equipment so that the patient's chin reaches the chinrest.

6. Ask the patient to stand in the center of the equipment and direct them to remain in the position outlined below.
 - Hold the handles tightly.
 - Press the chest against the equipment.
 - Keep both feet close to the inside of the base.
 - Keep both shoulders parallel.
 - Straighten the Cervical Spine and stand still.
7. Ask the patient to press the base of the nose (acanthion point) against the chinrest and tilt the head forward about 5°.

IMPORTANT

Ensure that the patient's jaw does not touch the equipment to maintain the proper posture until the end of imaging.

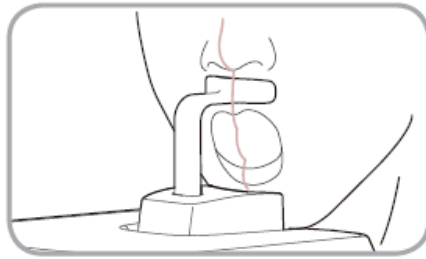

8. Ask the patient to maintain the posture as follows:
 - Open the mouth.
 - Place the tongue on the roof of the mouth.
 - Close the eyes.



NOTICE

- As shown in the picture, the support unit of the integrated chinrest should touch the patient's acanthion point.
- Ask the patient to maintain his/her position until the operation is completed.

Laser Beam Alignment

 WARNING	Ensure that the laser beam does not directly enter the patient's eyes. This may lead to vision loss.
 CAUTION	Ensure to align the laser beam properly. Distortions can be found in the captured images, such as ghost shadows, if the laser beam is not correctly positioned.

1. Align the Vertical Beam with the center of the face (Mid-sagittal Line). (It's to prevent the horizontal expansion of the image)
2. Use the Horizontal Beam button on the control panel to position it. Align the Horizontal Beam straight to the Frankfurt Line on the patient's face. Make sure that the Horizontal Beam is aligned to the patient's face horizontally.



Finishing Patient Positioning

1. After checking the positions of the patient and the laser beam, click the **Temple Supports OPEN/CLOSE** button on the control panel to prevent the patient's head from moving.

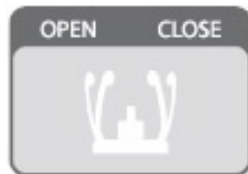

 CAUTION	Ensure that the temple supports are at the CLOSE position before clicking the READY button.
--	--

2. Click the **READY** button. X-ray exposure has not started yet.
3. Move to **7.4 X-ray Exposure** to start the exposure.

7.3.2.2 TMJ Close (LAT / PA)

You can proceed with TMJ close mode only after finishing the TMJ open mode. To acquire a TMJ close image, follow the procedure below:

Patient Positioning

1. "Do you want to capture a TMJ Close image?" message will appear when the TMJ Open mode is completed. Press/Click the **OK** button to begin TMJ Close mode.

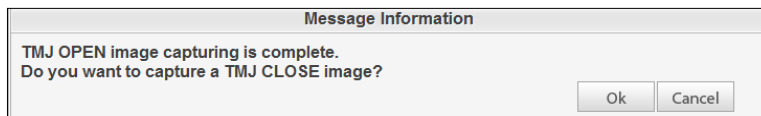

2. Guide the patient to the equipment.
3. Ask the patient to place the base of the nose (acanthion point) against the Chinrest and bend the head forward about 5°
4. Ask the patient to maintain the posture as follows:
 - Close the mouth.
 - Place the tongue on the roof of the mouth.
 - Close the eyes.

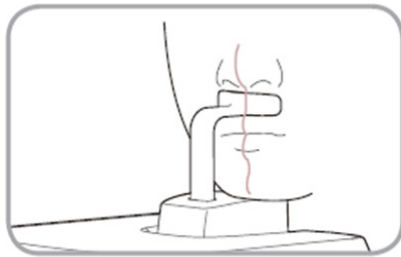

NOTICE

- As shown in the picture, the support unit of the integrated Chinrest should touch the patient's acanthion point.
- Let the patient maintain his/her position until the operation is completed.

Laser Beam Alignment

This is the same as the one for **TMJ Open Mode**.

Finishing Patient Positioning

This is the same as the one for **TMJ Open Mode**.

7.3.2.3 Sinus Mode (LAT / PA)

To acquire a sinus image, follow the procedure below:

Patient Positioning

1. Remove the **Normal Chinrest** and insert the **Special Chinrest** into the equipment.
2. Insert the Special Bite A into the Special Chinrest

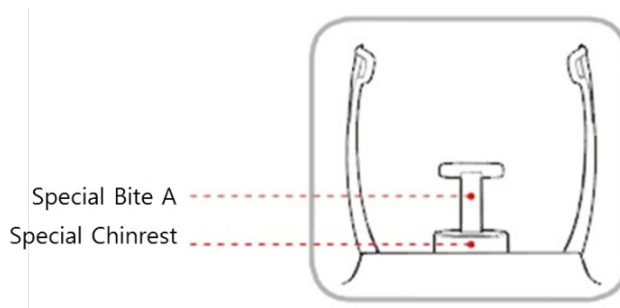

Clean the chinrest and the bite with a non-alcoholic chlorine dioxide-based product and wipe with a dry towel before the next patient.

3. Use the **Temple Supports OPEN/CLOSE** button to widen the Temple Supports on the control panel.

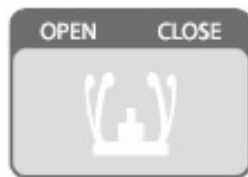

4. Guide **the** patient to the equipment.
5. Use **the Column UP/DOWN** button or switch option to adjust the height of the equipment so that the patient's chin reaches the chinrest.

6. Guide the patient to stand on the center of the equipment and direct them to remain in the position outlined below.
 - Hold the handles tightly.
 - Press the chest against the equipment.
 - Keep both feet close to the inside of the base.
 - Keep both shoulders parallel.
 - Straighten the Cervical Spine and stand still.
7. Ask the patient to maintain the base of the nose (acanthion point) against the Chinrest and tilt the head forward about 5°.

IMPORTANT

Ensure that the patient's jaw does not touch the equipment to maintain the proper posture until the end of imaging.

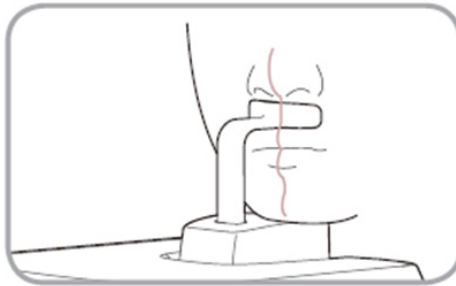

8. Ask the patient to maintain the posture as follows:
 - Close the mouth.
 - Place the tongue on the roof of the mouth.
 - Close the eyes.



NOTICE

- As shown in the picture, the support unit of the integrated Chinrest should touch the patient's acanthion point.
- Ask the patient to maintain his/her position until the operation is completed.

Laser Beam Alignment

 WARNING	Ensure that the laser beam does not directly enter the patient's eyes. This may lead to vision loss.
 CAUTION	Ensure to align the laser beam properly. Distortions can be found in the captured images, such as ghost shadows, if the laser beam is not correctly positioned.

1. Align the Vertical Beam with the center of the face (Mid-sagittal Line). (It's to prevent the horizontal expansion of the image)
2. Use the Horizontal Beam button on the control panel to position it. Align the Horizontal Beam straight to the Frankfurt Line on the patient's face. Make sure that the Horizontal Beam is aligned to the patient's face horizontally.

Finishing Patient Positioning

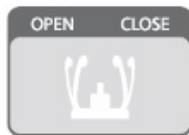

1. After checking the positions of the patient and the Laser Beam, click the **Temple Supports OPEN/CLOSE** button on the control panel to prevent the patient's head from moving.



 CAUTION	Ensure that the temple supports are at the CLOSE position before clicking the READY button.
--	---

2. Click the **READY** button. X-ray exposure has not started yet.
3. Move to **7.4 X-ray Exposure** to start the exposure.

7.4 X-ray Exposure

 WARNING	<ul style="list-style-type: none"> ▪ Release the Exposure Switch to stop X-ray emission if an emergency occurs during the image acquisition. ▪ The operator must follow the X-ray safety regulation and guidelines during the operation.
 CAUTION	<ul style="list-style-type: none"> ▪ The operator must keep vocal/visual contact with the patient during the image acquisition. ▪ Do not operate the PC during exposure.
IMPORTANT	<ul style="list-style-type: none"> ▪ Ask patients to close their eyes during the operation. ▪ Ask patients to hold their breath and stop swallowing during the image acquisition. ▪ Ask patients to stay in their positions until the Temple Supports are open again.

1. Move out of the X-ray room and close the door.
2. Press and hold down the **Exposure Switch** until image acquisition is completed.

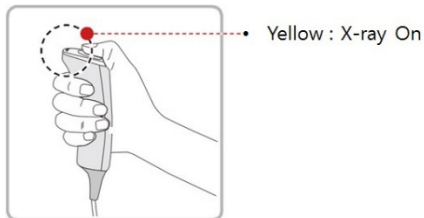

NOTICE	The image appears on the screen.
NOTICE	<p>During X-ray exposure, the status appears as follows:</p> <ul style="list-style-type: none"> ▪ The LED light of the Exposure Switch turns yellow. ▪ The LED light on the top of the equipment turns yellow. ▪ An alert sound comes out to indicate that X-ray emission is currently underway. ▪ On Console Software, the radiation mark turns yellow, and "X-RAY" changes to "X-RAY ON."



3. Release the **Exposure Switch** when the "Image capturing is completed" message appears on the screen.

7.5 Finishing the Scan

1. Open the temple supports and guide the patient out of the equipment.
2. Remove the sanitary vinyl cover from the normal bite.
3. Press the **READY** button to bring the rotating unit back to its initial position.

7.6 Checking the Captured Images

Acquired images can be reconstructed and converted to DICOM format.
The exported images can be confirmed in **EzDent-i**.

1. The images are transferred to **EzDent-i** automatically.
2. The images are automatically saved if the automatic save option is default. If it is not configured as default, click the **Save** button to save manually.
3. To check the image, double-click the image on the **Patient List**.

NOTICE

Refer to the **EzDent-i User Manual** for more information.

This Page Intentionally Left Blank

8. Acquiring CEPH Images (Optional)

8.1 CEPH Imaging Program Overview

■ Result Images



It provides conventional 2D cephalometric images.

■ Image Acquisition Method



It acquires multiple images by scanning the specific oral & maxillofacial regions with the linear movement of the linear detector and reconstructs them into a single 2D image through computer calculations.

■ Examination Programs

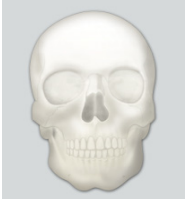
It is classified below based on the ROI (Region of Interest).

Examination Area	Description	Position
Lateral / Full Lateral (Optional)	<ul style="list-style-type: none"> Studies craniofacial disease, trauma, and congenital malformation examine the soft tissue in the otorhinolaryngological area, the sinus, and the hard palate. Measures the angles formed by the connecting lines between the cranial measurement points to further assess the growth of the facial region. It's widely used in Orthodontics and Oral and Maxillofacial Surgery. 	 <p><Lateral></p>  <p><Full Lateral></p>
PA	<ul style="list-style-type: none"> Directs the radiation from the posterior of the skull to the anterior. Examines cranial diseases, trauma, and congenital malformations. Assesses the growth of the lateral side of the face. It also examines the ramus mandibulae, the posterior region of the third-largest molar in the lower jaw, the sidewall of the maxillary sinus, the frontal sinus, antrum ethmoidal, olfactory and optic disc pits. Measures the angles formed by the connecting lines between the cranial measurement points to further assess the growth of the facial region. It is widely used in Orthodontics and Oral and Maxillofacial Surgery. 	 <p><PA></p>

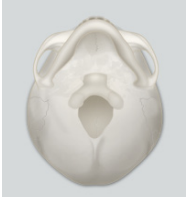
8. Acquiring CEPH Images (Optional)

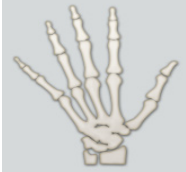
Examination Area	Description	Position
SMV	<ul style="list-style-type: none"> Studies the base of the skull, horizontal angulation of the mandibular condylar axis, the sphenoid sinus, the curvature of the lower jaw, the sidewall of the maxillary sinus, and zygomatic arch fractures. Also used to study the inner and outer alar plates and holes at the skull base. 	 <p data-bbox="1039 513 1115 537"><SMV></p>
Waters' view	<ul style="list-style-type: none"> Studies the frontal sinus, the antrum ethmoidal, the optic disc pit, the frontozygomatic suture, the nasal cavity, and the coronoid process between the upper jaw and the zygomatic arch. 	 <p data-bbox="1002 763 1152 786"><Waters' view></p>
Carpus	<ul style="list-style-type: none"> Assesses hand bone age to compare the changes in the skull. 	 <p data-bbox="1030 977 1125 1000"><Carpus></p>

8.2 Setting Exposure Parameters

Complete the steps in **6. Getting Started** before setting the exposure parameter on the console. You can also use the touch screen to set the exposure parameters.

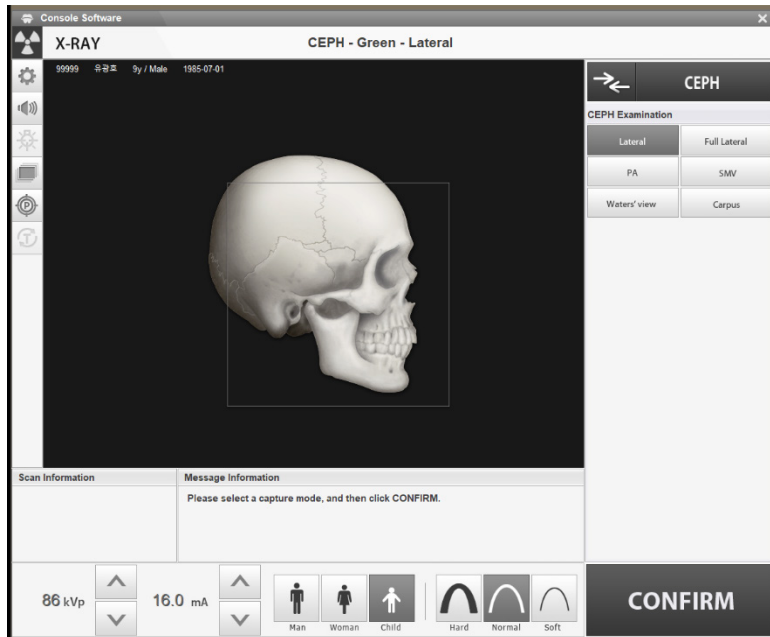

Console Software's Main Window

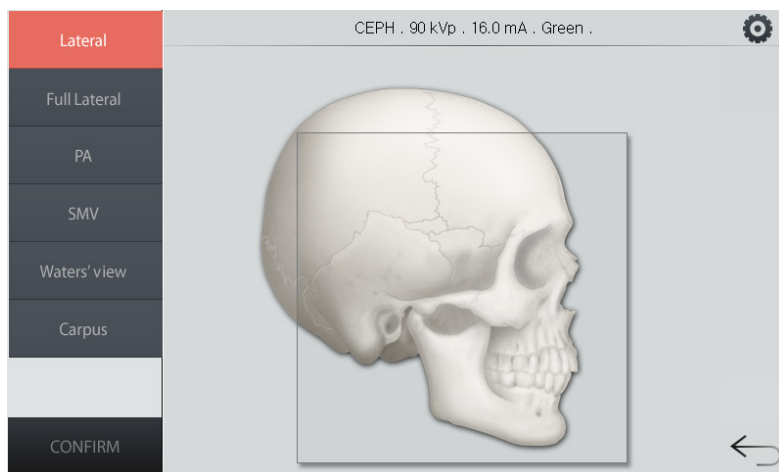

Touch Screen's Main Window

8. Acquiring CEPH Images (Optional)

1. Select **CEPH** from the Modality Option.

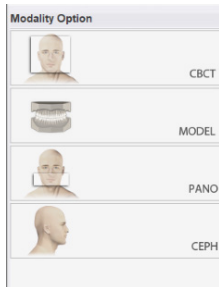

<Console Software>

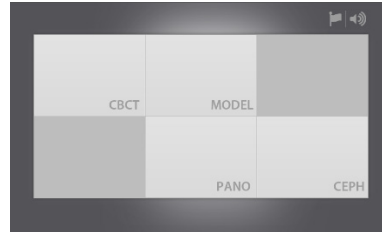

<Touch Screen>

NOTICE

“CEPH” is visible on the menu only when your equipment has the CEPH option.

2. Select an image option: **High Resolution** or **Green**.

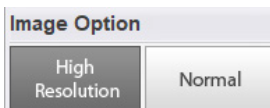

<Console Software>



<Touch Screen>

3. Select an examination program from **CEPH Examination** menu.



<Console Software>

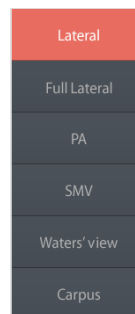

<Touch Screen>

4. The patient type is automatically selected by the patient information entered earlier. Confirm or change the patient type by clicking one of the buttons in the patient menu.



<Console Software>



<Touch Screen>

Mode		Vatech Standards
Child		2~12 years of age
Adult	Man	> 12 years of age
	Woman	

5. Select an X-ray intensity according to the patient's head circumference. In general, the X-ray intensity must increase proportionally to the size of the head circumference.



<Console Software>



<Touch Screen>

Age	Average Head Circumference (cm)	Range (cm)	X-ray Intensity
Child	53±3	>53±3	Hard
		53±3	Normal
		<53±3	Soft
Adult	56±3	>56±3	Hard
		56±3	Normal
		<56±3	Soft

6. Click the up-down button () to change the tube voltage and current values if you want to change the pre-selected values. Each time you click the button, the voltage value is changed by ± 1 kVp and the current by ± 0.1 mA.

NOTICE

The tube voltages and current values are automatically set by the patient type and the X-ray intensity.

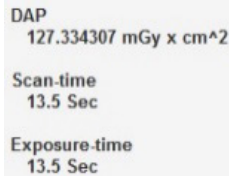

7. Click **CONFIRM** when all parameter settings are complete. When you click the CONFIRM button, the following will take place:
- The rotating unit moves to its initial scanning position.
 - The vertical beam activates.
 - The patient information window displays the DAP (Dose Area Product), scan time, and exposure time.



DAP	127.334307 mGy x cm ²
Scan-time	13.5 Sec
Exposure-time	13.5 Sec

8. Ask the patient to enter the unit.

8.3 Patient Positioning

 WARNING	<ul style="list-style-type: none"> Ask the patient (especially pregnant women and children) to wear a lead apron to protect him or her from radiation exposure. Ensure that the laser beam does not directly enter the patient's eyes. This may lead to vision loss.
 CAUTION	<p>Ensure that the Nasal Positioner is unfolded before adjusting the Ear Rods properly.</p>
IMPORTANT	<ul style="list-style-type: none"> Correct posture reduces the shadow cast by the patient's cervical spine and allows clear image acquisition. Metal implants or bridges can reduce the quality of the images.

Getting prepared

- Let the patient remove all the metal objects (glasses, earrings, hairpins, braces, false teeth, etc.). Metal objects can induce ghost images and lower image quality.
- Let the patient wear a lead apron to protect themselves from residual radiation.
- Use the **Column UP/DOWN** button or switch option to adjust the equipment to match the patient's height.

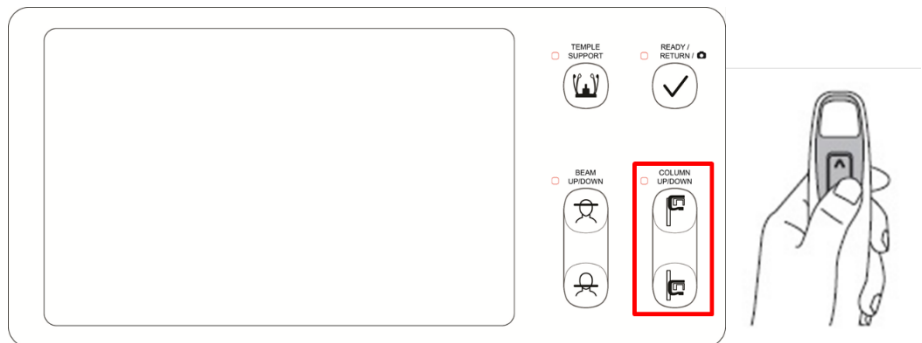

<Control Panel – LCD type>

8.3.1 Lateral / Full Lateral (Optional) Mode

NOTICE

Correct posture reduces the shadow cast by the patient's cervical spine and allows clear image acquisition.

Patient Positioning

1. Turn the nasal positioner to the **Lateral** mode positioning marker, as shown below.



2. Leave enough space between the Ear Rods.

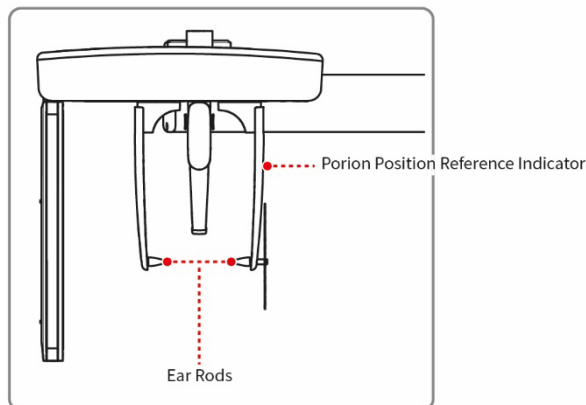

NOTICE

Use the Porion Position Reference Indicator that appears in the acquired image to confirm the location of Porion quickly.

3. Guide the patient to the CEPH unit.
4. Direct the patient to relax his/her neck and shoulders and stand upright.
5. Use the **Column UP/DOWN** button or switch option to adjust the height of the CEPH unit to approximately match the patient's height.

6. Align the Ear Rods to the patient's ears properly so that the head does not move during the operation. Then, align the Nasal Positioner with the patient's nasion by adjusting its height.

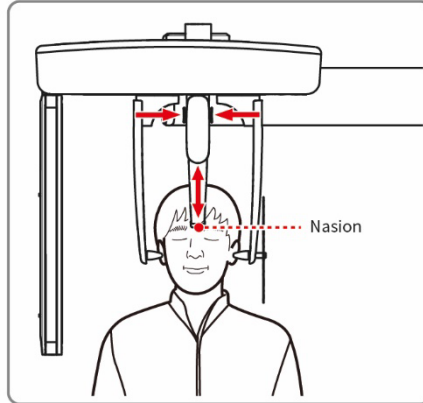

7. Align horizontally to let the patient's Frankfurt Line become parallel with the floor.

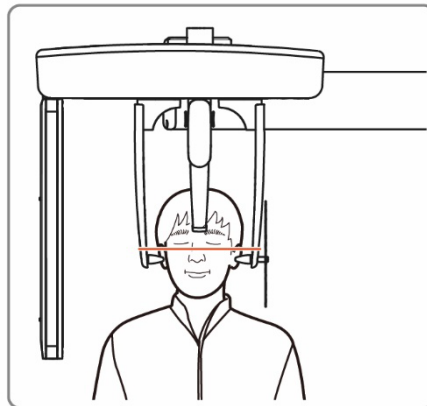

8. Ask the patient to swallow and stay in his or her current position until image acquisition ends.
9. Click the **READY** button. The x-ray exposure has not started yet.
10. Move to **8.4 X-ray Exposure** to start the exposure.

8.3.2 PA Mode

Patient Positioning

1. Turn the nasal positioner to the **PA / Waters' view / Carpus** mode positioning marker, as shown below.

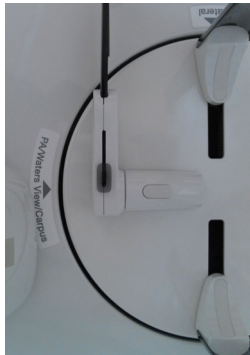

2. Fold the nasal positioner up. The nasal positioner is **NOT** used in PA mode.
3. Guide the patient to the CEPH unit.
4. Ask the patient to stand upright, facing the sensor. Make sure the patient's shoulders are level and his/her neck is relaxed.

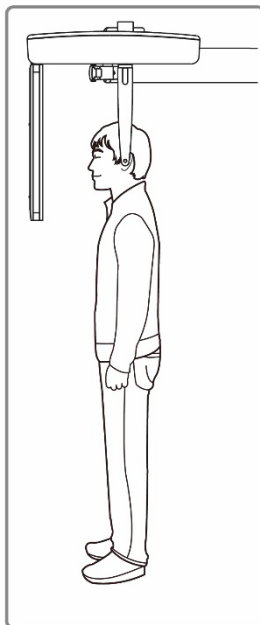

5. Use the **Column UP/DOWN** button or switch option to adjust the height of the CEPH unit to approximately match the patient's height.
6. Align the Ear Rods to the patient's ears so that the head does not move during the operation.
7. Align horizontally to let the patient's Frankfurt Line become parallel with the floor.

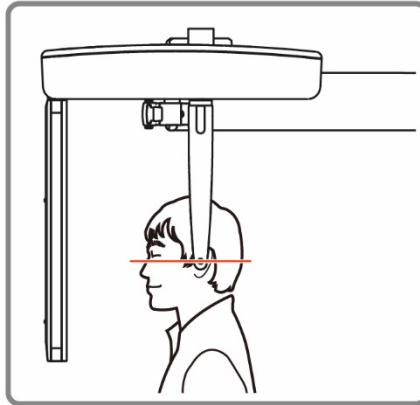

8. Ask the patient to swallow and stay in his or her current position until image acquisition ends.
9. Click the **READY** button. The x-ray exposure has not started yet.
10. Move to **8.4 X-ray Exposure** to start the exposure.

8.3.3 SMV Mode

Patient Positioning

1. As shown below, turn the nasal positioner to the SMV mode positioning marker.



2. Fold the nasal positioner up. The nasal positioner is **NOT** used in SMV mode.
3. Guide the patient to the CEPH unit.
4. Ask the patient to face the X-ray tube and stand upright.

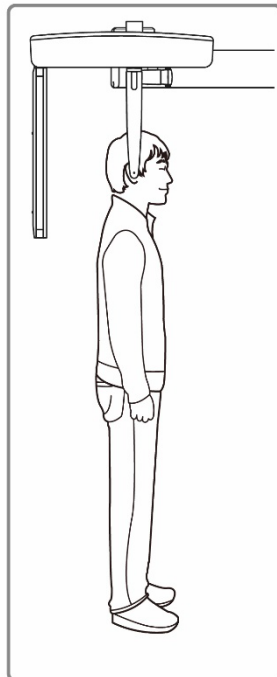

5. Use the Column **UP/DOWN** button or switch option to adjust the height of the CEPH unit to approximately match the patient's height.
6. Align the Ear Rods to the patient's ears so that the head does not move during the operation.
7. Carefully tilt the patient's head back to let the patient's Frankfurt Line become vertical with the floor.
8. Ask the patient to swallow and stay in his or her current position until image acquisition ends.

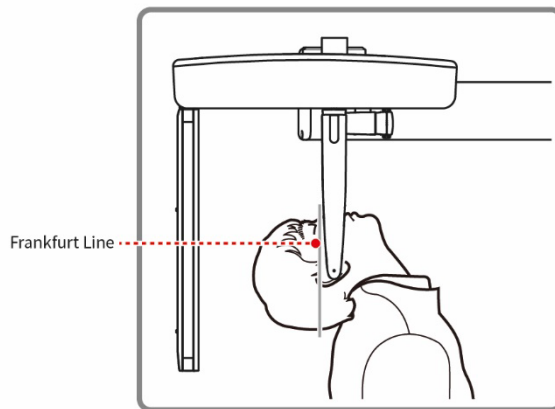

9. Click the **READY** button. The x-ray exposure has not started yet.
10. Move to **8.4 X-ray Exposure** to start the exposure.

8.3.4 Waters' View Mode

Patient Positioning

1. Turn the nasal positioner to the **PA / Waters' View / Carpus** mode positioning marker, as shown below.



2. Fold the nasal positioner up. The nasal positioner is **NOT** used in Waters' View mode.
3. Guide the patient to the CEPH unit.
4. Ask the patient to stand upright, facing the sensor. Make sure the patient's shoulders are level and his/her neck is relaxed.
5. Use the **Column UP/DOWN** button or switch option to adjust the height of the CEPH unit to approximately match the patient's height.



After adjusting the height of the column, align the Ear Rods to the patient.

6. Align the Ear Rods to the patient's ears so that the head does not move during the operation.
7. Direct the patient to swallow first before closing the mouth and guide the patient to bend the head 30° - 40° backward. Direct the patient to remain in the current position until image acquisition is completed.

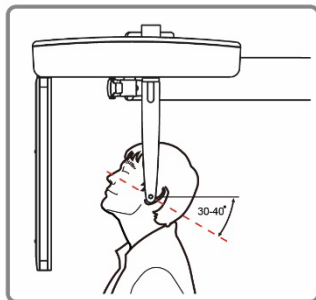

8. Click the **READY** button. The x-ray exposure has not started yet.
9. Move to **8.4 X-ray Exposure** to start the exposure.

8.3.5 Carpus Mode

For Carpus Mode, install the Carpus Plate first before positioning the patient.

Installing the Carpus Plate

1. Turn the nasal positioner to the **PA / Waters' View / Carpus** mode positioning marker, as shown below.



2. Fold the nasal positioner up. The nasal positioner is **NOT** used in Carpus mode.
3. Fit the two ends of the Carpus Plate into the two holes of the CEPH unit as below.

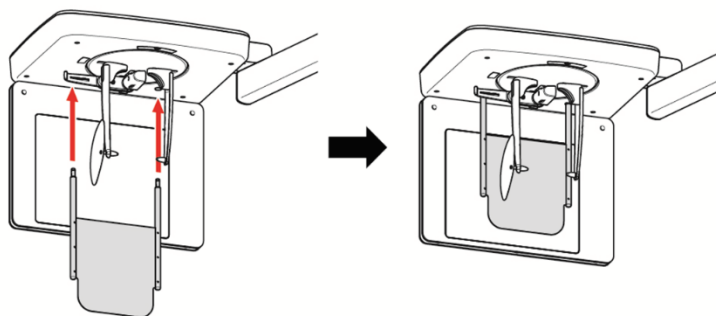

4. Confirm that the Carpus Plate is safely mounted.

Patient Positioning

1. Let the patient put his/her right hand splayed on the Carpus Plate, as shown below. Make sure that the patient does not bend his/her fingers.

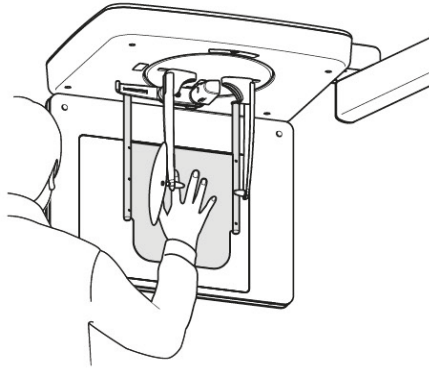

2. Ask the patient to close his/her eyes and stand still until the image acquisition is completed.
3. Click the **READY** button. The x-ray exposure has not started yet.
4. Move to **8.4 X-ray Exposure** to start the exposure.

8.4 X-ray Exposure



WARNING

- Release the **Exposure Switch** to stop X-ray emission if an emergency occurs during the imaging acquisition.
- The operator must follow the X-ray safety regulation and guidelines during the operation.



CAUTION

- The operator must keep vocal/visual contact with the patient during the image acquisition.
- Do not operate the PC during exposure.

IMPORTANT

- Ask patients to close their eyes during the operation.
- Ask patients to hold their breath and stop swallowing during the image acquisition.
- Ask patients to stay in their positions until the Temple Supports are open again.

1. Move out of the X-ray room and close the door.
2. Press and hold down the **Exposure Switch** until image acquisition is completed.

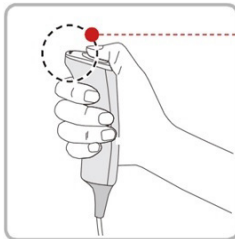

• Yellow : X-ray On

NOTICE

The image appears on the screen.

NOTICE

During X-ray exposure, the status appears as follows.

- The LED light of the **Exposure Switch** turns yellow.
- The LED light on the top of the equipment turns yellow.
- An alert sound comes out to indicate that X-ray emission is currently underway.
- On Console Software, the radiation mark turns yellow, and “X-RAY” changes to “X-RAY ON.”



X-RAY ON

3. Release the **Exposure Switch** when the “Image capturing is completed” message appears on the screen.

8.5 Finishing the Scan

1. Leave enough space between the Ear Rods.
2. Fold the nasal positioner up in case it's unfolded.
3. Guide the patient out of the equipment.

8.6 Checking the Captured Images

Acquired images can be reconstructed and converted to DICOM format. The exported images can be confirmed in **EzDent-i**

NOTICE

Refer to the **EzDent-i User Manual** for more information.

1. The images are transferred to **EzDent-i** automatically.
2. The images are automatically saved if the automatic save option is default. If it is not configured as default, click the **Save** button to save manually.
3. To check the image, double-click the image on the **Patient List**.

9. Acquiring CBCT Images

9.1 CBCT Imaging Program Overview

- **Result Images**

It provides conventional 3D CT sliced images.

- **Image Acquisition Method**

It acquires images with the X-ray beam scanning specific oral & maxillofacial regions and reconstructs them into 3D sliced images.

- **Examination Programs**

It is classified as below based on the FOV.

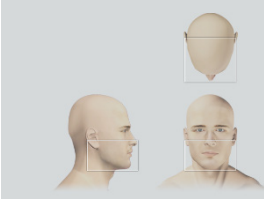
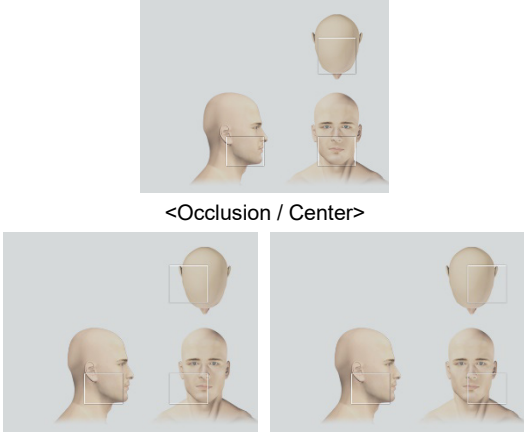
Available FOVs (cm)	ROI	Description
16x9	 <p data-bbox="570 1058 769 1083"><Occlusion / Center></p>	<p data-bbox="965 871 1167 1068">- Covers full arch region, sinus, and left/right TMJ. - Suitable for most oral surgery cases as well as multiple implant surgery.</p>
12x9	 <p data-bbox="570 1309 769 1335"><Occlusion / Center></p> <p data-bbox="463 1547 605 1572"><TMJ / Right></p> <p data-bbox="724 1547 865 1572"><TMJ / Left></p>	<p data-bbox="965 1213 1153 1464">- Covers both maxillary and mandibular structures, including the 3rd molar region. - TMJ Right/Left and Airway mode are available.</p>

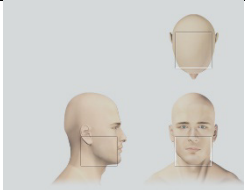
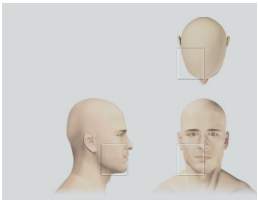
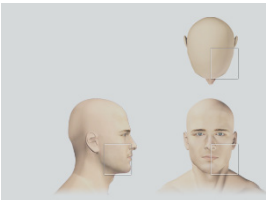
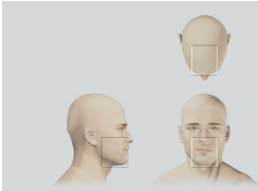
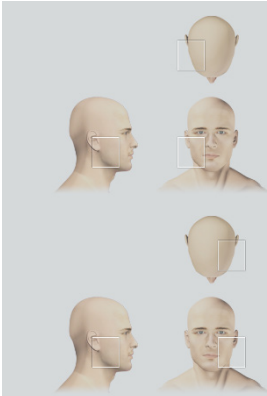
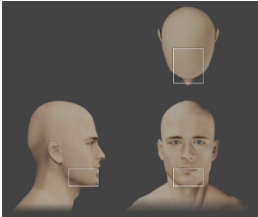
	 <p data-bbox="621 426 795 450"><Airway / Center></p>	
<p data-bbox="330 904 371 927">8x9</p>	<div data-bbox="443 465 699 662">  <p data-bbox="460 674 648 697"><Occlusion / Right></p> </div> <div data-bbox="710 465 974 662">  <p data-bbox="753 674 927 697"><Occlusion / Left></p> </div> <div data-bbox="580 705 836 894">  <p data-bbox="607 906 809 929"><Occlusion / Center></p> </div> <div data-bbox="576 937 841 1329">  <p data-bbox="502 1340 639 1363"><TMJ / Right></p> <p data-bbox="773 1340 897 1363"><TMJ / Left></p> </div>	<ul data-bbox="1002 819 1199 1016" style="list-style-type: none"> - Selectable FOV for region (left/center/right). - Covers both maxillary and mandibular areas and left/right TMJ.
<p data-bbox="330 1495 371 1518">8x5</p>	 <p data-bbox="611 1609 805 1632"><Mandible / Center></p>	<ul data-bbox="1002 1423 1199 1591" style="list-style-type: none"> - Selectable FOV for region (left/center/right). - Covers both maxillary and mandibular areas.

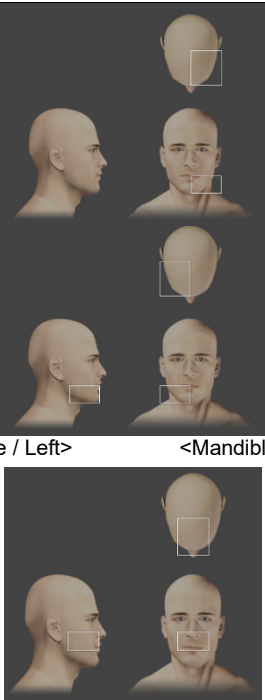
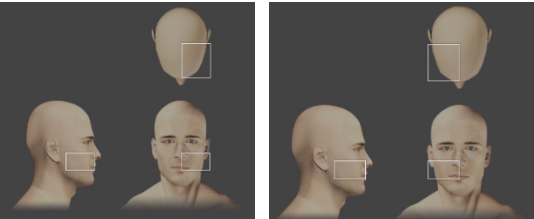
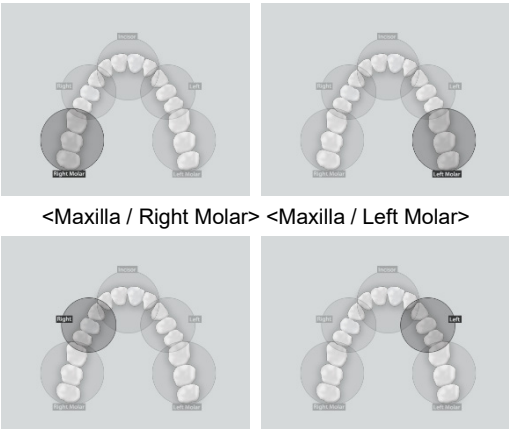
	 <p><Mandible / Left> <Mandible / Right></p> <p><Maxilla / Center></p>  <p>< Maxilla / Left> < Maxilla / Right></p>	
<p>5x5</p>	 <p><Maxilla / Right Molar> <Maxilla / Left Molar></p> <p><Maxilla / Right> <Maxilla / Left></p>	<ul style="list-style-type: none"> - Covers 3 ~ 4 areas through capturing ROI. - Can acquire 3 ~ 4 teeth at once. - Endo mode (Voxel Size: 0.08) applied.

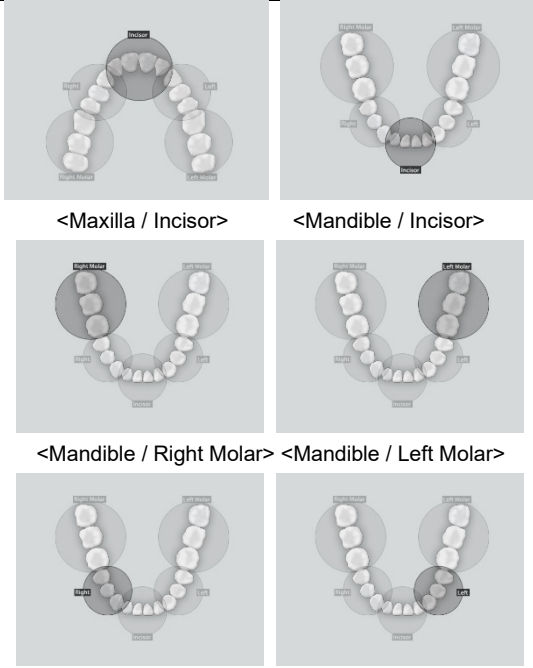
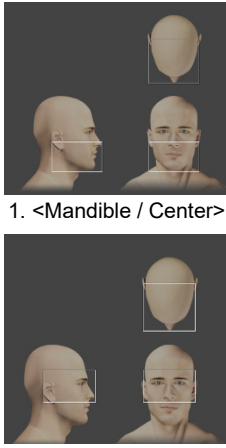
	 <p><Maxilla / Incisor> <Mandible / Incisor></p> <p><Mandible / Right Molar> <Mandible / Left Molar></p> <p><Mandible / Right> <Mandible / Left></p>	
<p>Double Scan (Optional)</p>	 <p>1. <Mandible / Center></p> <p>2. <Maxilla / Center></p> <hr style="border-top: 1px dashed black;"/> <div style="border: 1px solid black; padding: 5px; display: inline-block;"> <p>NOTICE</p> </div> <p>After taking 2 consecutive exposures in the order of "1 → 2", it is automatically synthesized and displayed as one full image.</p>	<ul style="list-style-type: none"> - Full arch, sinus, left and right TMJ area can be checked - Suitable for most intra-oral surgery, including multiple implant placement

9.2 Setting Exposure Parameters

Complete the steps in **6. Getting Started** before setting the exposure parameter on the console. You can also use the touch screen to set the exposure parameters.

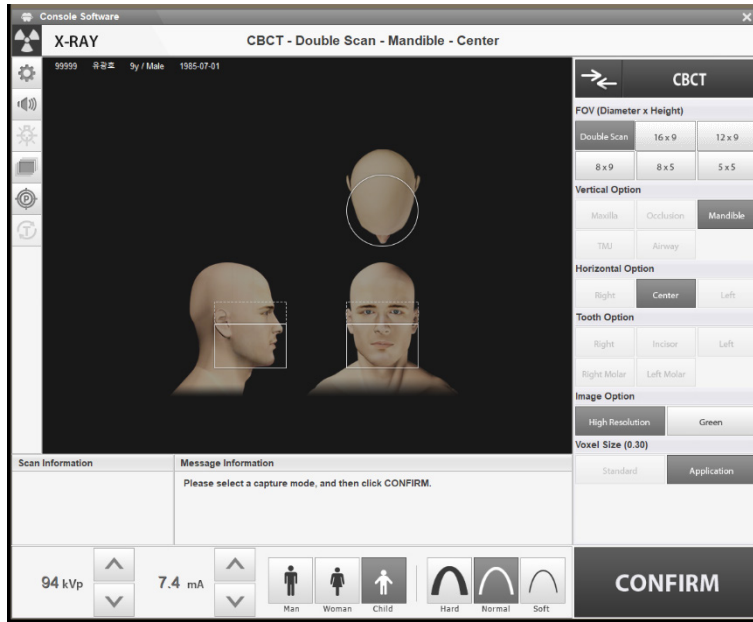

Console Software's Main Window

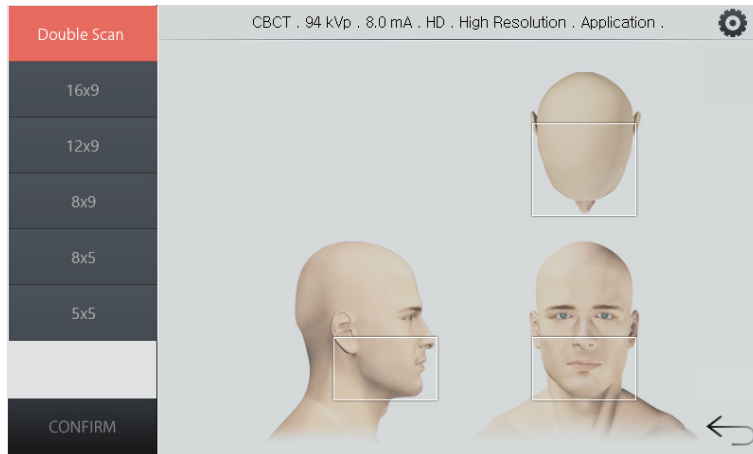

Touch Screen's Main Window

1. Select **CBCT** from the Modality Option.

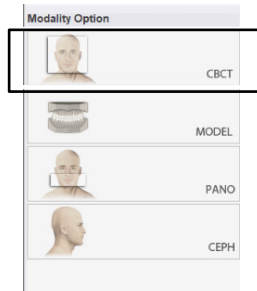

<Console Software>

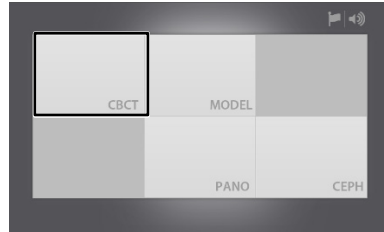

<Touch Screen>

2. Select a FOV (Field of View). Your selection automatically sets vertical Option, Horizontal Option, and Tooth Option. Go to the **table** to see corresponding options for each FOV selection.

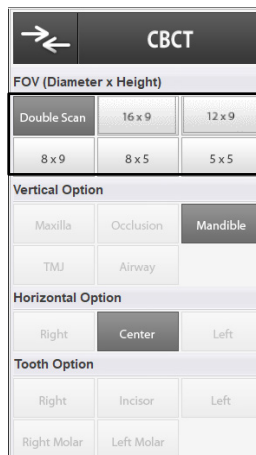

<Console Software>

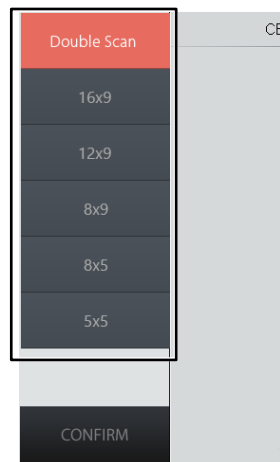

<Touch Screen>

9. Acquiring CBCT Images

Available FOV (cm)	Vertical option	Horizontal option	Tooth option
16x9	Occlusion	Center	N/A
12x9	Occlusion	Center	N/A
	TMJ	Right	
		Left	
Airway	Center		
8x9	Occlusion	Right	N/A
		Center	
		Left	
	TMJ	Right	
		Left	
8x5	Maxilla	Right	N/A
		Center	
		Left	
	Mandible	Right	N/A
		Center	
		Left	
5x5	Maxilla / Mandible	N/A	Right Molar
			Right
			Incisor
			Left
			Left Molar
16x15 (Double Scan; 16x9 stitching) (Optional)	Mandible (First Scan) Maxilla (Second Scan)	Center	N/A

3. Select an image option: **High resolution** or **Green**.



4. Select a Voxel Size: **Standard** or **Application**.



5. The patient type is automatically selected by the patient information entered earlier. Confirm or change the patient type by clicking one of the buttons in the patient menu.



Mode		Vatech Standards
Child		2~12 years of age
Adult	Man	> 12 years of age
	Woman	

6. Select an X-ray intensity according to the patient's head circumference. See the table for the suggested X-ray intensities for different head circumferences



<Console Software>



<Touch Screen>

Age	Average Head Circumference (cm)	Range (cm)	X-ray Intensity
Child	53±3	>53±3	Hard
		53±3	Normal
		<53±3	Soft
Adult	56±3	>56±3	Hard
		56±3	Normal
		<56±3	Soft

7. Click the up-down button () to change the tube voltage and current values if you want to change the pre-selected values. Each time you click the button, the voltage value is changed by ±1 kVp and the current by ± 0.1 mA.

NOTICE

The tube voltages and current values are automatically set by the patient type and the X-ray intensity.

8. Click **CONFIRM** when all parameter settings are complete. When you click the **CONFIRM** button, the following will take place:
- The rotating unit moves to its initial scanning position.
 - The vertical beam activates.
 - The patient information window displays the DAP (Dose Area Product), scan time, and exposure time.

```
DAP
127.334307 mGy x cm^2

Scan-time
13.5 Sec

Exposure-time
13.5 Sec
```

9. Ask the patient to enter the unit.

9.3 Acquiring a Double Scan Image (optional)

Double scan mode provides a full radiographic image of the upper and lower jaw. The system runs a rapid scan of upper and lower jaws and stitches two images into one image.

The following sections explain how to set exposure parameters for the double scan (see section 9.3.1 and 9.3.2). Ensure to complete the steps in 6. **Getting Started** before setting the parameters.

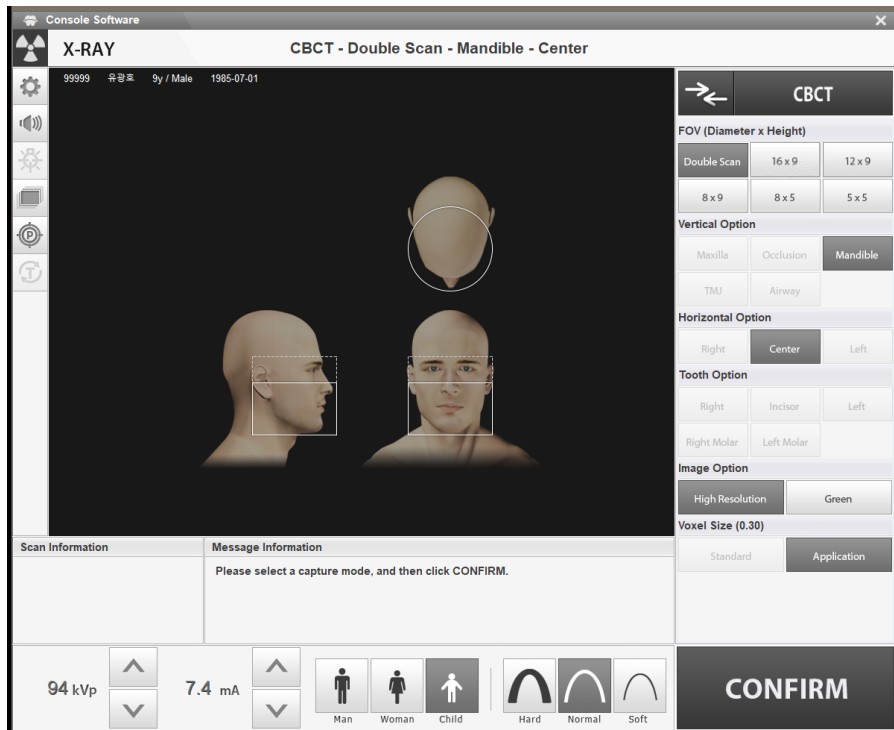

9.3.1 Acquiring the First Scan Image

Follow the procedure below to complete the first part of the double-scan procedure.

1. Click **Double Scan** from the FOV menu.

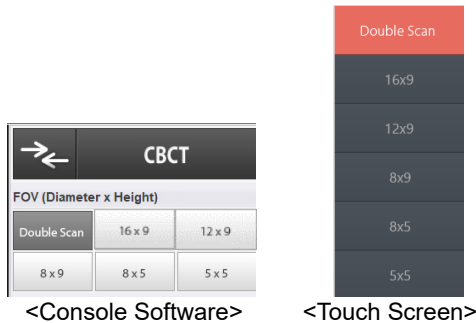

2. Select an image option: **High Resolution** or **Green**.
3. The patient type is automatically selected by the patient information entered earlier. Confirm or change the patient type by clicking one of the buttons in the patient menu.
4. Select the image option. Click the **settings** first when you are using the touch screen.
5. Select the X-ray intensity according to the patient's head circumference.
6. Click the up-down button () to change the tube voltage and current values if you want to change the pre-selected values. Each time you click the button, the voltage value is changed by ± 1 kVp and the current by ± 0.1 mA.

NOTICE

The tube voltages and current values are automatically set by the patient type and the X-ray intensity.

7. Press **CONFIRM** when all parameter settings are complete. The **CONFIRM** button turns to the **READY** button.

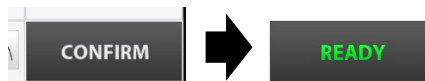

8. Ask the patient to enter the unit and position according to **9.4 Patient Positioning**.

9. Press **READY**. The x-ray exposure has not started yet.
10. Follow the procedure in **9.5 X-ray exposure** to launch the X-ray.
11. Ask the patient to leave the X-ray room.

9.3.2 Acquiring the Second Scan Image

Follow the procedure below to complete the second part of the double-scan procedure.

1. Click Maxilla from the Vertical Option menu.



2. Click the up-down button () to change the tube voltage and current values if you want to change the pre-selected values. Each time you click the button, the voltage value is changed by ± 1 kVp and the current by ± 0.1 mA.
3. Click **CONFIRM**. When you click the **CONFIRM** button, the following will take place:
 - The rotating unit moves to its initial position.
 - The vertical beam is activated
 - The patient information window displays the DAP (Dose Area Product), scan time, and exposure time.

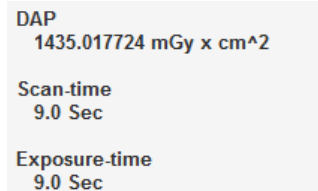

4. Ask the patient to enter the unit and position according to **9.4 Patient Positioning**.
5. Press **READY**. The x-ray exposure has not started yet.
6. Follow the procedure in **9.5 X-ray exposure** to launch the X-ray.
7. Ask the patient to leave the X-ray room and check the image quality following the procedure in **9.6 Finishing the Scan**.

9.4 Patient Positioning



- Ask the patient (especially pregnant women and children) to wear a lead apron to protect him or her from radiation exposure.
- Ensure that the laser beam does not directly enter the patient's eyes. This may lead to vision loss.



- Correct posture reduces the shadow cast by the patient's cervical spine and allows clear image acquisition.
- Metal implants or bridges can reduce the quality of the images.
- Ensure to adjust the laser beam correctly. Otherwise, the quality of images can be lowered due to ghost images or expansion/reduction of the images.

Getting prepared

1. Let the patient remove all the metal objects (glasses, earrings, hairpins, braces, false teeth, etc.). Metal objects can induce ghost images and lower image quality.
2. Let the patient wear a lead apron to protect themselves from residual radiation.
3. Use the **Column UP/DOWN** button or switch option to adjust the equipment to match the patient's height.

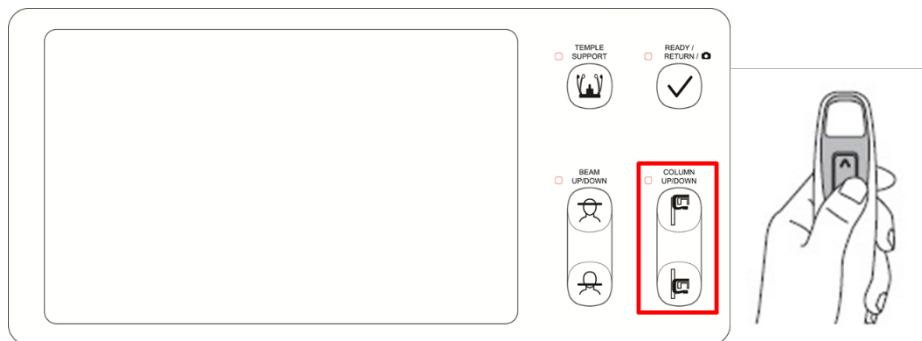

< Control Panel – LCD type >

Normal Patient Positioning

1. Insert the normal bite into the normal chinrest and cover it with a sanitary vinyl.

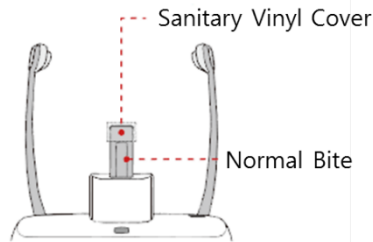

CAUTION



- The sanitary vinyl cover is for single use only. It should be replaced for each patient. Ensure to use the approved vinyl cover.
- Clean the chinrest and the bite with a non-alcoholic chlorine dioxide-based product and wipe with a dry towel before the next patient.

2. Use the **Temple Supports OPEN/CLOSE** button to widen the temple supports.

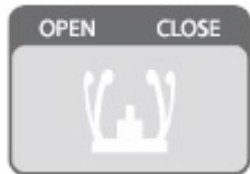

3. Guide the patient to the equipment.
4. Use the **Column UP/DOWN** button or switch option to adjust the height of the equipment so that the patient's chin reaches the Chinrest.
5. Ask the patient to stand in the center of the equipment and direct them to remain in the position outlined below.
 - Hold the handles tightly.
 - Press the chest against the equipment.
 - Keep both feet close to the inside of the base.
 - Keep both shoulders parallel.
 - Straighten the Cervical Spine and stand still.

6. Ask the patient to bite the normal bite along its grooves with his/her front teeth.

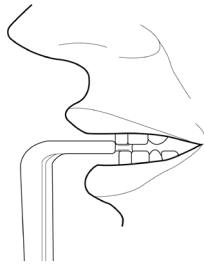

7. Ask the patient to maintain the posture as follow:
 - Close the mouth.
 - Place the tongue on the roof of the mouth.
 - Close the eyes.

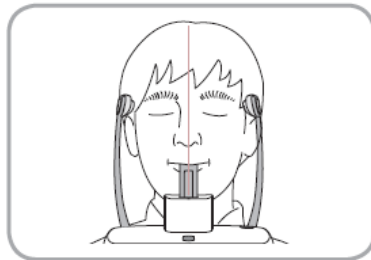

Double Scan (Mandible) Patient Positioning

1. Remove the **Special Chinrest** and insert the **Normal Chinrest** into the equipment.
2. Insert the **Special Bite B** into the **Normal Chinrest**.

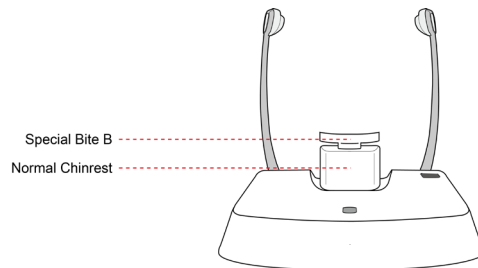

3. Use the **Temple Supports OPEN/CLOSE** button to widen the Temple Supports.

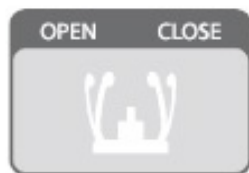

4. Guide the patient to the equipment.
5. Use the **Vertical Frame Up/Down** button or switch option to adjust the height of the equipment so that the patient's chin reaches the Chinrest.

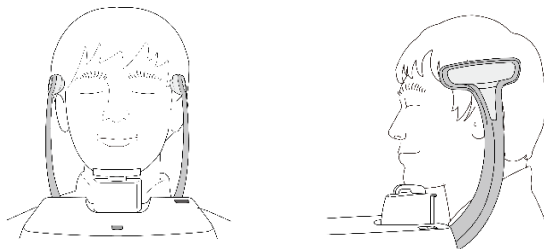

6. Ask the patient to stand in the center of the equipment and direct them to remain in the position outlined below.
 - Hold the handles tightly.
 - Press the chest against the equipment.
 - Keep both feet close to the inside of the base.
 - Keep both shoulders parallel.
 - Straighten the cervical spine and stand still.

7. Ask the patient to maintain the posture as follows:
 - Close the eyes.

Double Scan (Maxilla) Patient Positioning

1. Remove the Normal Chinrest and Special Bite B.
2. Insert the **Double Scan Support** into the equipment, then cover with a sanitary vinyl cover.

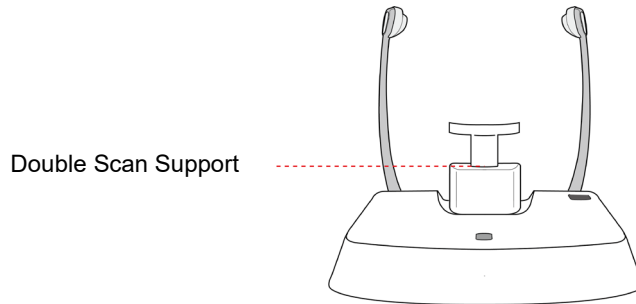

CAUTION

The sanitary vinyl cover is for single use only. It should be replaced for each patient. Ensure to use the approved vinyl cover.



3. Use the **Temple Supports OPEN/CLOSE** button to widen the temple supports.

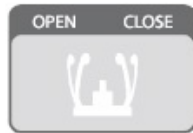

4. Guide the patient to the equipment.
5. Use the **Vertical Frame Up/Down** button or switch option to adjust the height of the equipment so that the patient's chin reaches the chinrest.

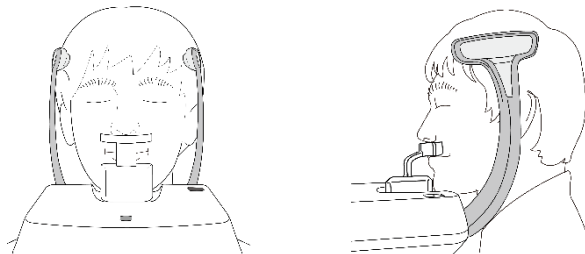

6. Ask the patient to stand in the center of the equipment and direct them to remain in the position outlined below.
 - Hold the handles tightly.
 - Press the chest against the equipment.
 - Keep both feet close to the inside of the base.
 - Keep both shoulders parallel.
 - Straighten the Cervical Spine and stand still.

7. Ask the patient to maintain the posture as follows:
 - Maintain position.
 - Close the eyes.

TMJ Patient Positioning

1. Remove the **Normal Chinrest** and insert the **Special Chinrest** into the equipment.
2. Insert the Special Bite A into the Special Chinrest

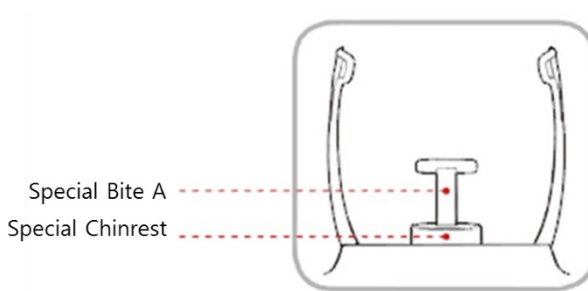

3. Use the **Temple Supports OPEN/CLOSE** button to widen the temple supports.

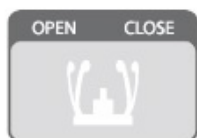

4. Guide the patient to the equipment.
5. Use the **Vertical Frame Up/Down** button or switch option to adjust the height of the equipment so that the patient's chin reaches the chinrest.
6. Ask the patient to stand in the center of the equipment and direct them to remain in the position outlined below.
 - Hold the handles tightly.
 - Press the chest against the equipment.
 - Keep both feet close to the inside of the base.
 - Keep both shoulders parallel.
 - Straighten the Cervical Spine and stand still.
7. Ask the patient to maintain the posture as follows:
 - Close the eyes.

Laser Beam Alignment

Ensure that the laser beam does not directly enter the patient's eyes. This may lead to vision loss.



Ensure to align the laser beam properly. Distortions can be found in the captured images, such as ghost shadows, if the laser beam is not correctly positioned.

Vertical Beam
/ Mid-sagittal plane

Horizontal Beam
/ Frankfurt plane

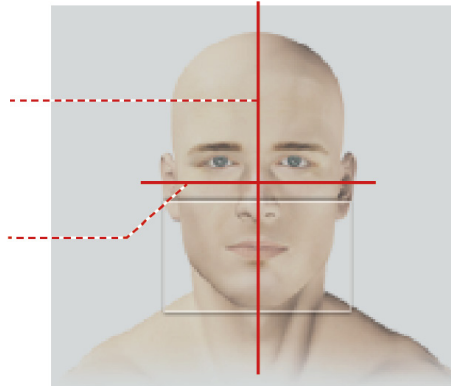

e.g. FOV 16 X 9

NOTICE

This is a sample illustration for reference only. Actual FOV may vary from the image, as shown above.

IMPORTANT

- The horizontal beam is used to point to the center of the height within the FOV.
- Unlike in the PANO mode, the horizontal beam does not move in the CT model.

1. Align the Vertical Beam with the center of the face (Mid-sagittal Line) to prevent the horizontal expansion of the image.

Finishing Patient Positioning

1. After checking the positions of the patient and the Laser Beam, click the **Temple Supports OPEN/CLOSE** button on the control panel to prevent the patient's head from moving.

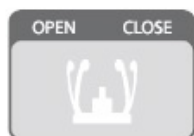

Ensure that the temple supports are at the CLOSE position before clicking the **READY** button.

2. Click the **READY** button. X-ray exposure has not started yet.
3. Move to **9.5 X-ray Exposure** to start the exposure.

9.5 X-ray Exposure



WARNING

- Release the **Exposure Switch** to stop X-ray emission if an emergency occurs during the imaging acquisition.
- The operator must follow the X-ray safety regulation and guidelines during the operation.



CAUTION

- The operator must keep vocal/visual contact with the patient during the image acquisition.
- Do not operate the PC during exposure.

IMPORTANT

- Ask patients to close their eyes during the operation.
- Ask patients to hold their breath and stop swallowing during the image acquisition.
- Ask patients to stay in their positions until the Temple Supports are open again.

1. Move out of the X-ray room and close the door.
2. Press and hold down the **Exposure Switch** until image acquisition is completed.

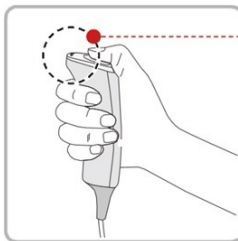

• Yellow : X-ray On

NOTICE

The image appears on the screen.

NOTICE

During X-ray exposure, the status appears as follows.

- The LED light of the Exposure Switch turns yellow.
- The LED light on the top of the equipment turns yellow.
- An alert sound comes out to indicate that X-ray emission is currently underway.
- On Console Software, the radiation mark turns yellow, and "X-RAY" changes to "X-RAY ON."



X-RAY ON

3. Release the **Exposure Switch** when the "Image capturing is completed" message appears on the screen.

9.6 Finishing the Scan

1. Open the temple supports and guide the patient out of the equipment.
2. Remove the sanitary vinyl cover from the normal bite.
3. Press the **READY** button to bring the rotating unit back to its initial position.

9.7 Checking the Captured Images

Acquired images can be reconstructed and converted to DICOM format.
The exported images can be confirmed in **EzDent-i**

NOTICE

Refer to the **EzDent-i User Manual** for more information.

1. The images are transferred to **EzDent-i** automatically.
2. The images are automatically saved if the automatic save option is default. If it is not configured as default, click the **Save** button to save manually.
3. To check the image, double-click the image on the **Patient List**.
4. **Ez3D-i** runs automatically for 3D viewing.

10. Acquiring 3D MODEL Scan Images

10.1 3D MODEL Scan Imaging Program Overview

- **Result Images**



It provides 3D modeling surface data of the Plaster Cast. (STL file)

- **Image Acquisition Method**

It acquires images with the X-ray beam scanning the Plaster Cast, reconstructs them to 3D sliced images, and converts them into 3D modeling surface data.

- **Examination Programs**

It is classified as below based on the MODEL type.

Applied FOV (cm)	Vertical Option	ROI	Description
8x9	Upper (Maxilla)		Captures a whole maxillary Plaster Cast.
	Lower (Mandible)		Captures a whole mandibular Plaster Cast.

10.2 Setting Exposure Parameters

Complete the steps in **6. Getting Started** before setting the exposure parameter on the console. You can also use the touch screen to set the exposure parameters.

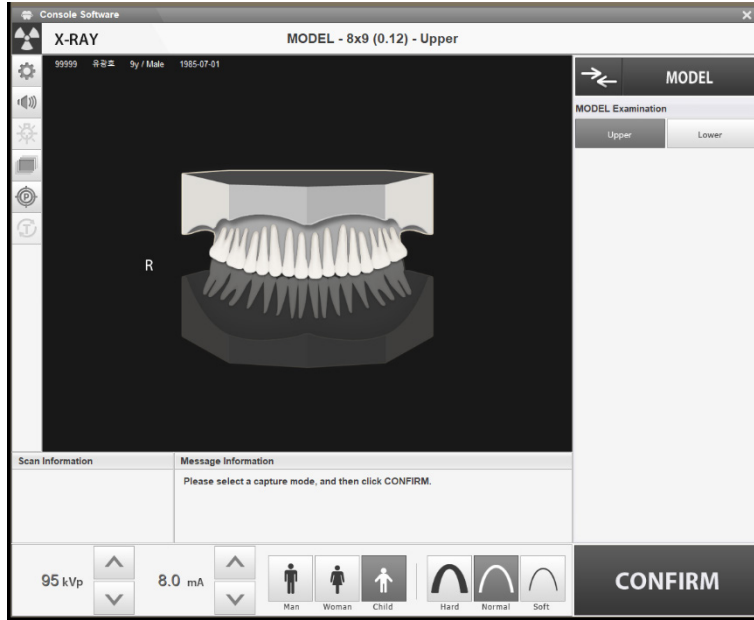

3D Model Main Window (Console Software)

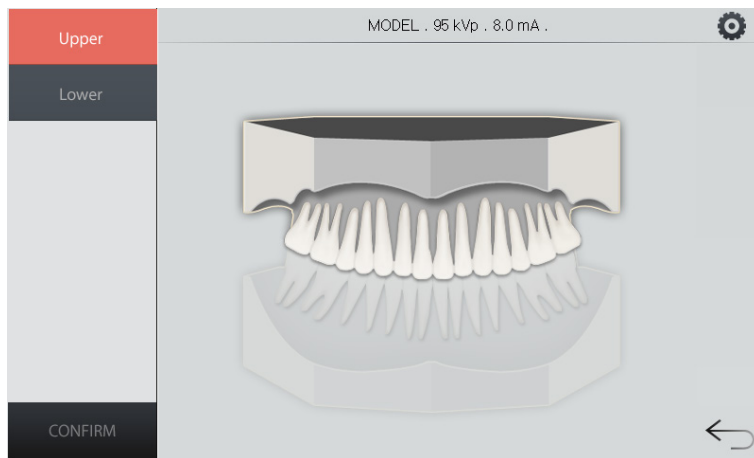

Touch Screen's Main Window

Follow the procedure below to set exposure parameters for the 3D model Scan:

1. Click **MODEL** from the modality menu.
2. Select Upper or Lower.
3. The patient type is automatically selected by the patient information entered earlier. Confirm or change the patient type by clicking one of the buttons in the patient menu.



<Console Software>

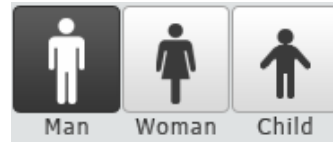

<Touch Screen>

4. Select the X-ray intensity.



<Console Software>



<Touch Screen>

5. Click the up-down button to change the tube voltage and current values if you want to change the pre-selected values. Each time you click the button, the voltage value is changed by ± 1 kVp and the current by ± 0.1 mA

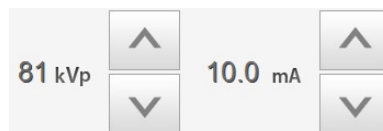

<Console Software>

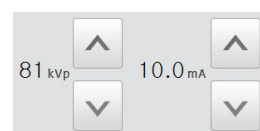

<Touch Screen>

6. Click **CONFIRM** when all parameter settings are completed.
7. Prepare the plaster cast to take the next step (see 10.3 MODEL Positioning)

10.3 MODEL Positioning

MODEL Scan Jig Installation

1. Remove the temple supports and the chinrest.
2. Insert the MODEL scan jig.

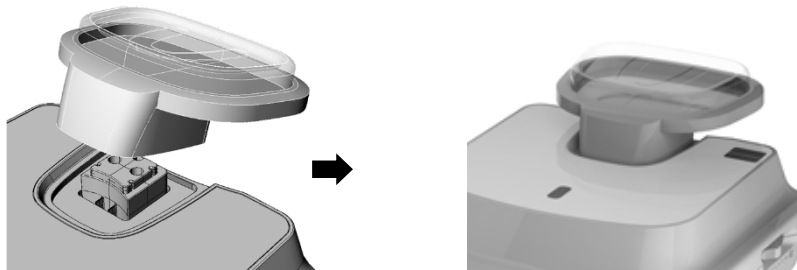

Laser Beam Alignment

1. Put the plaster cast on the MODEL scan jig. (Whether the plaster cast is for maxilla or mandibular, place it flat side down.)



2. Align the mid-sagittal plane laser beam at the center of the plaster cast to prevent the horizontal expansion of the image.



3. Click the **READY** button. X-ray exposure has not started yet.
4. Move to **10.4 X-ray Exposure** to start the exposure

10.4 X-ray Exposure



Do not operate the PC during exposure. Doing so may cause the system to malfunction.

1. Move out of the X-ray room and close the door.
2. Press and hold down the **Exposure Switch** until image acquisition is completed.

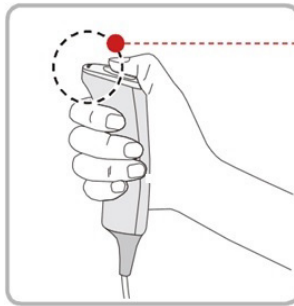

• Yellow : X-ray On

NOTICE

The image appears on the screen.

NOTICE

During X-ray exposure, the status appears as follows.

- The LED light of the **Exposure Switch** turns yellow.
- The LED light on the top of the equipment turns yellow.
- An alert sound comes out to indicate that X-ray emission is currently underway.
- On Console Software, the radiation mark turns yellow, and “X-RAY” changes to “X-RAY ON.”



X-RAY ON

3. Release the **Exposure Switch** when the “Image capturing is completed” message appears on the screen.
4. Remove the plaster cast out of the equipment.

10.5 Checking the Captured Images

Acquired images can be reconstructed and converted to DICOM or STL (Stereo Lithography).

NOTICE

Refer to the **EzDent-i User Manual** for more information.

1. The images are transferred to **EzDent-i** automatically.
2. The images are automatically saved if the automatic save option is default. If it is not configured as default, click the **Save** button to save manually.
3. To check the image, double-click the image on the **Patient List**.
4. You can check the captured image with a 3rd party STL viewer.

This Page Intentionally Left Blank

11. Troubleshooting

11.1 Troubleshooting

If a problem occurs while operating the equipment, perform the corresponding troubleshooting measures outlined below. If the problem persists, please contact our customer support staff.

If the equipment is not working

Cause	Actions to be taken
Failure of power supply	Check the equipment's power supply.
Initialization status	Wait until the equipment has been initialized, and then try again.
Failure of the Control PC's connection	Check the Communication Port (Optic) connection status, which connects the PC to the equipment.

If the Exposure Switch is not functioning

Cause	Actions to be taken
Failure of readiness	Check whether the Console Software is ready for imaging.

If imaging cannot be performed

Cause	Actions to be taken
Failure of initialization	Wait until the equipment is initialized and then try again. If this problem persists, restart the equipment.

If the Laser Beam has shut off and patient positioning cannot be performed

Cause	Actions to be taken
Expiration of the time allotted for patient positioning	Press the Laser Beam button to turn on the Laser Beam.

11.2 Error Codes

Error codes appear when the system detects abnormal activities. When you see the error code on the control panel or the console window, contact VATECH for help.

Error code is displayed in the format below:

[Code: **E00X.0XX.0XX**]

The code consists of three parts: Main code, Subcode, and Tail code.

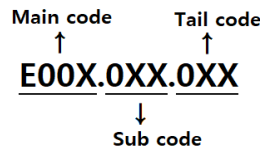

NOTICE

- **The main code** describes the source of error codes. The source is categorized as hardware, software, an acquisition module, etc.
- **Subcode** describes the specific area where the error has occurred according to the main code.
- **The tail code** describes the specific symptoms and causes of the errors mentioned in the subcode.

11.2.1 Main code - Hardware (001)

11.2.1.1 Subcode – Generator related error (001)

Tail code	Description
001	Appears when the tube is not ready for use
002	Appears when the cable between the tube tank and Inverter board is disconnected
003	Appears when a current of the inverter board exceeds the maximum allowable level during X-ray irradiation
004	Appears when there is $\pm 10\text{kV}$ or more voltage difference in tube voltage compared to a reference value
005	Appears when there is $\pm 0.5\text{mA}$ or more current difference in tube current compared to a reference value
006	Appears when there is $\pm 20\text{kV}$ or more voltage difference in tube voltage feedback compared to the average value
007	Appears when there is $\pm 1\text{mA}$ or more current difference in tube current feedback compared to the average value
008	Appears when the temperature of the mono tank is above the setting temperature

Tail code	Description
009	Appears when the inverter output current is higher than 1A during X-ray irradiation (In EP, IP condition)
010	Appears when the inverter board falsely recognizes the exposure switch signal as OFF after the irradiation on command
011	Appears when the X-ray OFF command is not sent to the inverter board in 0.5 seconds after turning off the exposure switch
012	Appears when kV feedback is over -20kV compared to the setting value during X-ray irradiation
013	Appears when kV feedback is over +20kV compared to the setting value during X-ray irradiation.
014	Appears when the mA feedback value is less than 50% compared to setting conditions during X-ray irradiation.
015	Appears when the mA feedback value is higher than 150% compared to setting conditions during X-ray irradiation.

11.2.1.2 Sub code - Motor related error (002)

Tail code	Description
020	Appears during p-axis motor origin movement
021	Appears during rotator-axis motor origin movement
027	Appears during Cephalo sensor motor origin movement
030	Appears during quadruple axis collimator Left origin movement
031	Appears during quadruple axis collimator Right origin movement
032	Appears during quadruple axis collimator Up origin movement
033	Appears during quadruple axis collimator down origin movement
037	Appears during generator tilting
038	Appears during temple support the motor operation
039	Appears during X-axis motor origin movement
040	Appears during Y-axis motor origin movement

11.2.1.3 Subcode – Exposure Switch related error (003)

Tail code	Description
060	Appears if the exposure switch is pressed when turning on the equipment.

11.2.1.4 Subcode – Other error (004)

Tail code	Description
102	Appears when there is no response during CAN communication.

11.2.2 Main code – Software (002)**11.2.2.1 Sub code – Sequence related error (001)**

Tail code	Description
001	Appears when the packing mode is enabled
002	Appears when the door is open
003	Appears when the exposure switch is pressed

11.2.2.2 Sub code – PC Resolution related error (010)

Tail code	Description
001	Appears when the resolution is less than 1280x1024
002	Appears when the resolution is less than 1200x960

11.2.2.3 Subcode – PC Network related error (024)

Tail code	Description
002	Appears when the port is invalid
003	Appears when the time is out

11.2.3 Main code - Acquisition Module (003)**11.2.3.1 Sub code – Initialization Failure related error (010)**

Tail code	Description
000	Appears when the COM port cannot be opened
001	Appears when the frame grabber interface cannot be initialized or memory for acquisition cannot be reserved

Tail code	Description
002	Appears when the MCU is not communicable or the modem ring signal is in an improper state

11.2.3.2 Sub code – Capture Failure related error (020)

Tail code	Description
000	Appears when there is a capture error

11.2.3.3 Sub code – Reconstruction Failure related error (030)

Tail code	Description
001	Appears when bugs exist in VXM-file or there is insufficient memory

11.2.3.4 Subcode – Hardware related error (061)

Tail code	Description
HW Error No	Appears when the error occurs during acquisition module operation

12. Cleaning and Disinfection



To prevent product contamination and deformation, clean the equipment and its accessories according to the guidelines in this section.

Before you start cleaning or disinfecting the equipment:

- Turn off the equipment.
- Wear safety gloves.
- Select the product that does not contain the following: phenol, acetic acid, peroxide, sodium hypochlorite, isopropyl alcohol (2-propanol, isopropanol), iodine-splitting agents, and oxygen-splitting agents.

When you are cleaning or disinfecting the equipment:

- Read and follow the instructions written on the cleaning agent's label.
- Do not apply liquids inside the unit.
- Do not spray liquid over the surface of the equipment.
- Wipe the areas thoroughly after cleaning until no liquid is left.

 WARNING	Cleaning with the power still on may lead to serious injury for you and other people around the equipment.
 WARNING	VATECH does not recommend or endorse cleaning products. It is the user's responsibility to determine what product is adequate to use for cleaning based on FDA and local regulations.
 WARNING	Spraying or pouring liquid into the equipment may cause a fire, electric shock, and serious damage to the equipment.

12.1 Cleaning

The accessories and parts that have contact with the patient’s mucous membranes must be cleaned between each patient use, including:

- Normal / Special A / Special B bite
- Temple Supports
- Chinrest
- Nasal Positioner
- Ear Rods

When you clean the accessories or the parts, use:

- A soft cloth
- Chlorine dioxide-based and non-alcoholic cleaning products

The following tables describe the proper procedure for each part and accessory:

Accessory /Part	Procedure
Bite (Normal / Special A / Special B / Deep Bite*)	1) Remove all visible soil with a paper wipe or disposable cloth. 2) Gently wipe the target areas clean using a soft cloth dampened with a cleaning product. 3) Dry the components or accessories with a paper wipe or clean & dry cloth until no liquid is left.
Temple Supports	
Chinrest	
Computer and Peripherals	Clean the components following the manufacturer’s instructions in the accompanying manual.
Outer Covers of Equipment	Wipe the covers with a dry cloth once a day.

*Deep bite is provided only in Asian countries, including Japan.

IMPORTANT	Do not use abrasive liquids such as acetone, gas, or oil, for they may cause corrosion on the equipment’s surface.
IMPORTANT	Do not use a product that contains silicone. Silicone-based products may damage the equipment’s electrical component.
IMPORTANT	Always dampen the cloth with the cleaning agent. (Do not soak the cloth into liquids.)

12.2 Disinfection

Follow the precautions below when you choose a disinfectant for the equipment.

- Use disinfectants that satisfy the national and regional standards. Your region's regulatory body must approve selected disinfectants for their safety.
- Use a disinfectant product for the parts that are frequently touched or come to contact with the patients and staff.
- Use a non-alcoholic chlorine dioxide-based disinfectant.
- Do not use a UV sterilizer to disinfect the equipment. UV light can discolor the surface of the equipment.
- Always follow the direction on the label.

This Page Intentionally Left Blank

13. Maintenance

VATECH requires periodic constancy tests to ensure image quality and the safety of the patient and the operator.

Only **VATECH**-authorized technicians can perform inspection and service for the equipment. Contact the **VATECH** service center or your local **VATECH** representative for technical assistance.

13.1 Regular Maintenance



- Always turn off the equipment before performing any maintenance.
- Do not remove equipment covers. There are no repairable parts inside.
- The only parts that the user can replace are the input fuses, which must comply with the manufacturer's specifications.
- As a precaution against fire, the replacement should be one in the same type and range.



- There are no user-serviceable parts inside this equipment.
- If any service is required, please contact your local **VATECH** representative.

- Do not unplug cables by force.
- Do not expose the equipment or components in an area susceptible to water or humidity.
- Do not expose the equipment in an area of extreme fluctuation in temperature, poor ventilation, direct sunlight, dust, salt, etc.
- Keep all detachable components well organized and clean.
- Ensure that the equipment is well-grounded.
- Do not try to modify this equipment, including the wires or cables. Doing so may damage it beyond repair.

13.1.1 Maintenance Task Checklist

Tasks	Period
Before the operation, ensure that the equipment is clean and ready for use. Ensure that all parts that come in direct contact with the patient have been cleaned thoroughly.	Daily
After using the equipment, ensure that the Main Power Switch has been turned off.	Daily
Ensure that the equipment is firmly plugged into a dedicated power source.	Daily
Ensure that the plug and the power cord are not heated abnormally.	Daily
Confirm that the LED indicator turns yellow when the Exposure Switch is pressed. Ensure that the LED indicator remains yellow for the entire duration of the exposure.	Daily
Ensure that the power cable is not kinked, broken, exposed, and free of all other defects.	Daily
Confirm that activating the Emergency Stop Switch ceases the unit's operation. Pressing the Emergency Stop Switch should stop all movement of the equipment and X-ray emission.	Weekly
Ensure that all visible labels are intact and legible.	Weekly
Check for possible damages to the Exposure Switch cable.	Monthly
Confirm that the audio message is audible throughout the exposure.	Monthly

14. Disposing of the Equipment

This equipment is designed for safe use and disposal. Many components of the equipment, except some parts like the X-ray tube, are environmentally friendly and recyclable.

All parts and components of hazardous materials must be disposed of by disposal regulations (IEC 60601-1 6.8.2 j).

Parts	Materials	Recyclable	To the special disposal site	Hazardous waste; Needs Separate Collection
Frame and Covers	Aluminum and plastics	•		
Motors		•		
Circuit Boards		•		
Cables and Transformer	Copper	•		
	Steel	•		
	Oil		•	
Packing	Wood	•		
	Cardboard	•		
	Paper	•		
X-ray Tube				•
Sensor Head	Return the Sensor Head to VATECH			
Other parts			•	



This dental equipment shall not be disposed of as domestic garbage materials.

IMPORTANT

Clean / Disinfect / Sterilize the equipment before disassembling it and disposing of its parts.

NOTICE

Check all regulations relevant to the disposal of waste in your country.

This Page Intentionally Left Blank

15. Technical Specifications

15.1 Mechanical Specifications

15.1.1 Dimensions (unit = mm)

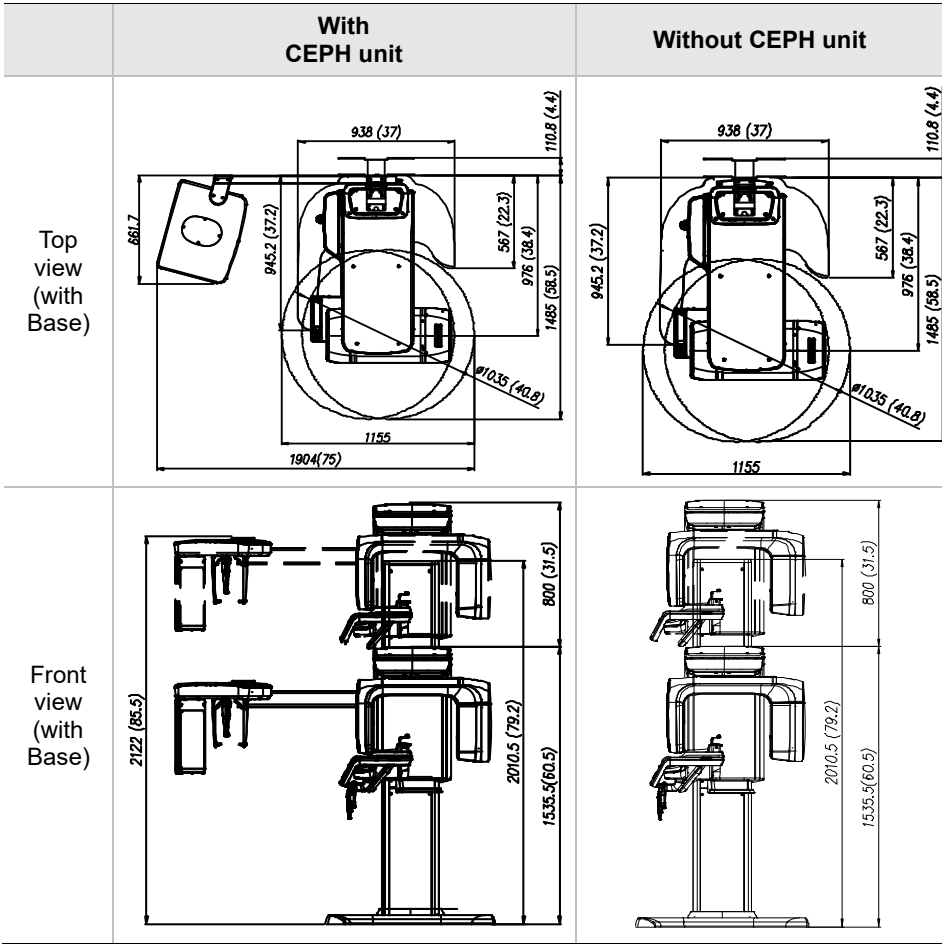

15. Technical Specifications

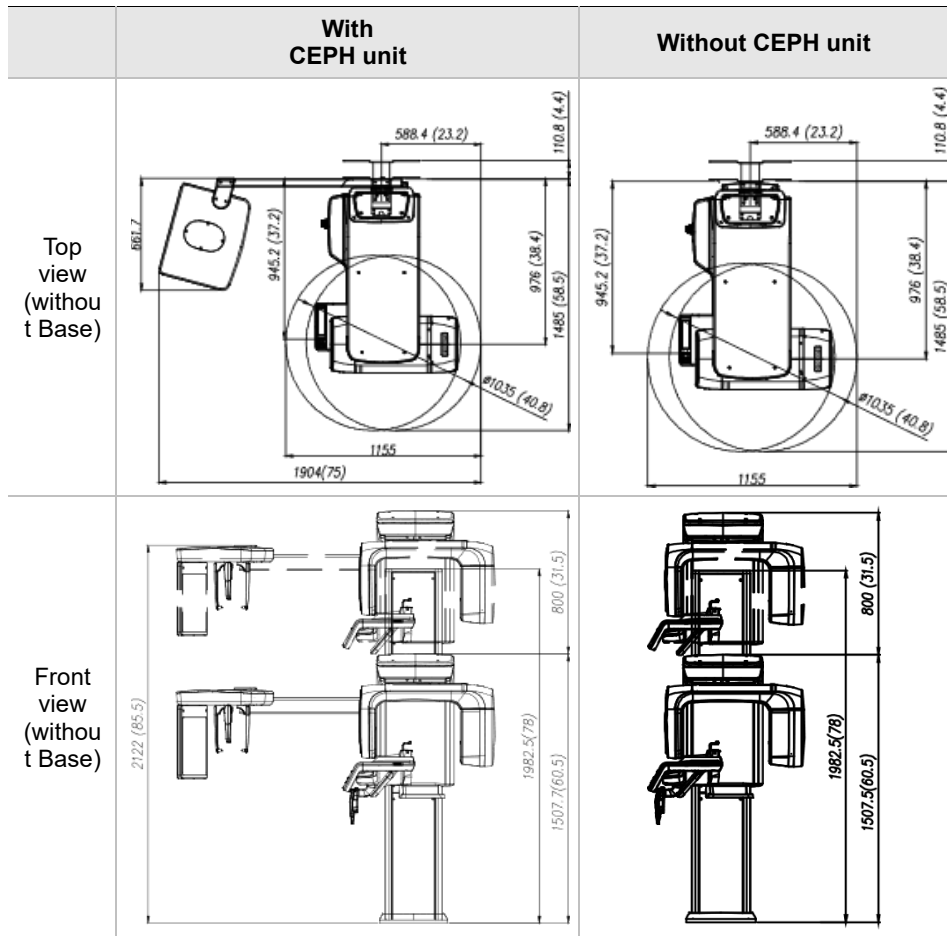

(Wall bracket dimensions)

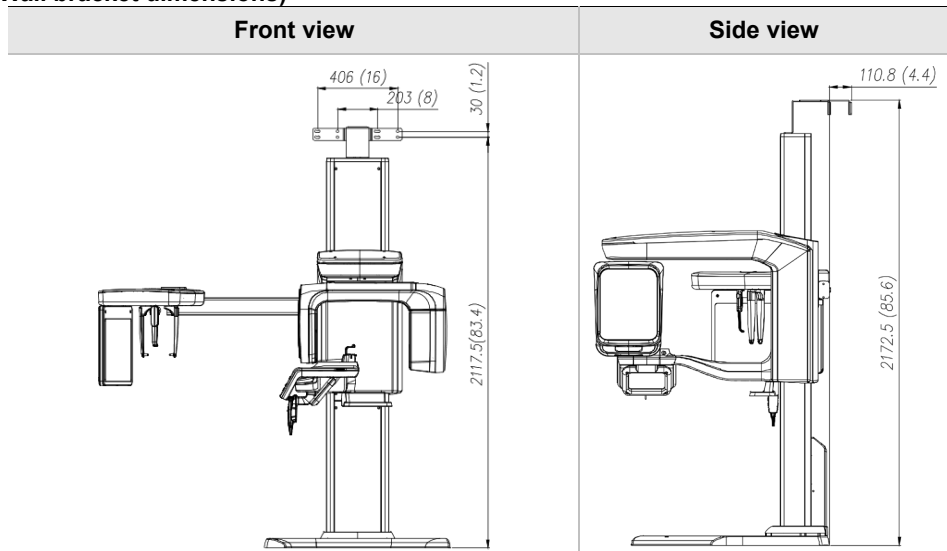

Item		Description
Weight	Without CEPH unit	137 kg (302.0 lbs. – without Base)
		190 kg (418.9 lbs. – with Base)
	With CEPH unit	162 kg (357.1 lbs. – without Base)
		215 kg (474.0 lbs. – with Base)
Total Height	Without Base	Max. 2307.5 mm (90.9")
	With Base	Max. 2335.5 mm (92.0")
Dimensions during operation (Length x Width x Height)	Without CEPH unit	1155.0 (L) x 1595.8 (W) x 2307.5 (H) (mm, without Base) 45.5 (L) x 62.9 (W) x 90.9 (H) (inch, without Base)
		1155.0 (L) x 1595.8 (W) x 2335.5 (H) (mm, with Base) 45.5 (L) x 62.9 (W) x 92.0 (H) (inch, without Base)
	With CEPH unit	1904.0 (L) x 1595.8 (W) x 2307.5 mm (H) (mm, without Base) 75.0 (L) x 62.9 (W) x 90.9 (H) (inch, without Base)
		1904.0 (L) x 1595.8 (W) x 2335.5 (H) (mm, with Base) 75.0 (L) x 62.9 (W) x 92.0 (H) (inch, with Base)
Rotating Unit Vertical Movement		Max. 800.0 mm (31.5")
Installation Type		Base Stand/Wall Mount (Default: Wall Mount type)
Packing Box Organization		Main Box, CEPH Box (Optional), Base Box (Optional)

15.1.2 Image Magnification

Mode	FDD (mm)	FOD (mm)	ODD (mm)	Magnification
PANO	600	477.7	122.3	1 : 1.25
CEPH	1745	1524	221.0	1 : 1.14
CBCT	600	428.6	171.4	1 : 1.40

- **FDD:** Focal Spot to Detector Distance
- **FOD:** Focal Spot to Object Distance
- **ODD:** Object to Detector Distance (ODD = FDD - FOD)
- **Magnification** = FDD / FOD

15.2 Technical Specifications

15.2.1 X-ray Generator Specifications

Specifications

Item		Description	
Generator	Model	DG-07E22T2	
	Rated output power	1.6 kW	
	Inverter model name	INV-22	
	Type	Inverter	
	Normal / Pulse	kVp	60 kV ~ 99 kV (1 kV increment)
		mA	4 mA ~ 16 mA (0.1 mA increment for CBCT, 1 mA increment for PANO and CEPH)
	Cooling	Cooling Protect (Optional fan cooling $\geq 60^{\circ}\text{C}$)	
	Total filtration	Min. 2.5 mm Al	
	Default filtration	1.0 mm Al	
Added filtration	1.5 mm Al (Fixed) / PANO and CEPH mode 1.5 mm Al (Fixed) + 3.0 mm Al (Automatically added) / CBCT mode		
Tube	Manufacturer	Canon Electron Tubes & Devices	
	Model	D-052SB (Stationary Anode type)	
	Focal spot size	0.5 mm (IEC 60336)	
	Target Angle	5 degree	
	Inherent Filtration	At least 0.8 mm Al equivalent at 50 kV	
	X-ray Coverage	95 mm x 380 mm at SID 550 mm	
	Anode Heat Content	35 kJ	
	Duty Cycle	1:60 or more (Exposure time: Interval time)	

Test Condition

Mode	Tube Voltage (kVp)	Tube Current (mA)	Exposure Time (s)
PANO	60 ~ 90	4 ~ 14	13.5
	60 ~ 90	4 ~ 14	11.5
	60 ~ 90	4 ~ 14	11.3
	60 ~ 90	4 ~ 14	11.1
	60 ~ 90	4 ~ 14	9.2
	60 ~ 90	4 ~ 14	7.7
	60 ~ 90	4 ~ 14	7.0
	60 ~ 90	4 ~ 14	6.8
	60 ~ 90	4 ~ 14	6.7
	60 ~ 90	4 ~ 14	6.1
	60 ~ 90	4 ~ 14	5.8
	60 ~ 90	4 ~ 14	5.7
	60 ~ 90	4 ~ 14	5.2
	60 ~ 90	4 ~ 14	5.0
	60 ~ 90	4 ~ 14	3.7
	60 ~ 90	4 ~ 14	3.5
	60 ~ 90	4 ~ 14	3.3
	60 ~ 90	4 ~ 14	2.8
	CEPH	60 ~ 99	4 ~ 16
60 ~ 99		4 ~ 15	2.4
60 ~ 99		4 ~ 15	3.9
60 ~ 99		4 ~ 14	4.9
60 ~ 99		4 ~ 14	5.4
CBCT	60 ~ 99	4 ~ 12	9.0
	60 ~ 99	4 ~ 12	4.9

Maximum Rating Charts

Constant potential high-voltage generator
Nominal Focus Spot Value: 0.5

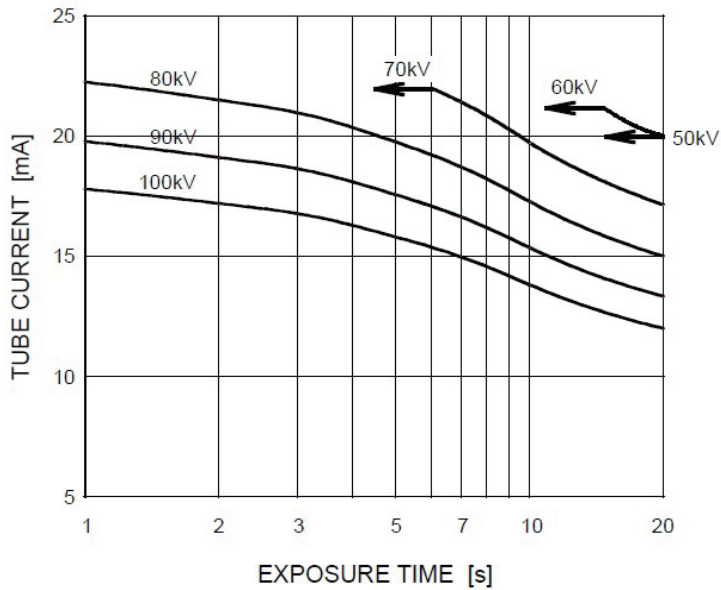

Emission & Filament Characteristics

Constant potential high-voltage generator
Nominal Focus Spot Value: 0.5

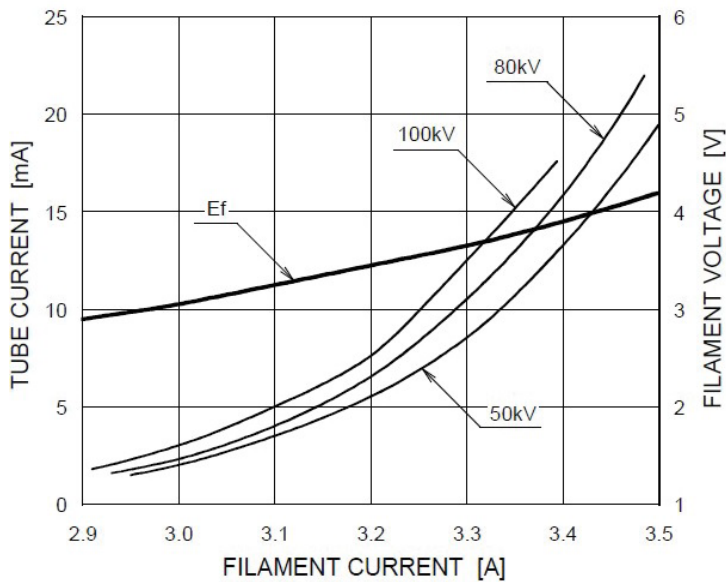

■ ■ Anode Thermal Characteristics

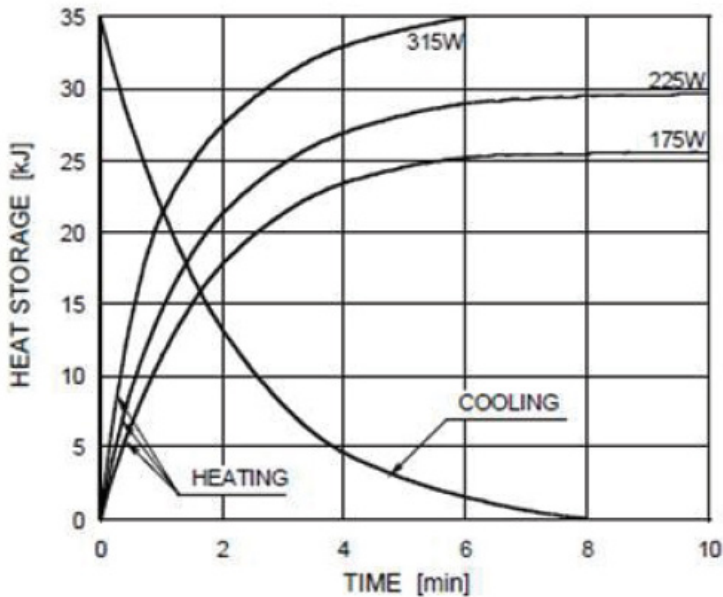

■ ■ X-ray Housing Assembly Tube Characteristics

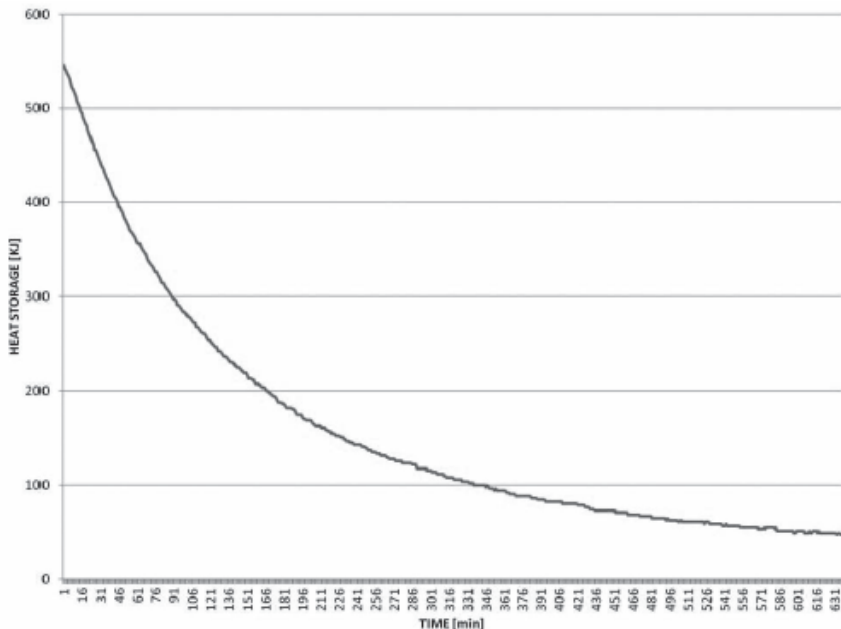

15.2.2 Detector Specifications

Item	Description	
	PANO & CBCT	CEPH
Model	Xmaru1314CF	Xmaru2602CF
Detector Type	CMOS photodiode array	
Pixel size	198 μm @ 4X4 binning (49.5 μm @ no binning)	200 μm @ 2x2 binning (100 μm @ no binning)
Active area	CBCT - 127.5 mm X 135.8 mm PANO - 5.9 mm X 135.8 mm	15.6 mm x 259 mm
Frame Rate	~ 108 Hz @ 4X4 binning	~ 330 Hz @ 2x2 binning
Analogue-Digital Conversion	14 bits	
Operating condition	10 ~ 35 °C (Temperature) 10 ~ 75 % (Humidity)	
Storage condition	-10 ~ 60 °C (Temperature) 10 ~ 75 % (Humidity)	
Sensor size	165 mm (L) x 230 mm (W) x 27 mm (H)	110 mm (L) x 279 mm (W) x 20 mm (H)
Sensor weight	1450 g	1050 g
Converter	Csl : Ti	
Energy Range	50 ~ 120 kVp	
Readout	Charge amplifier array	
Video Output	Optic	
MTF	> 45 % @ 1 lp/mm, > 10 % @ 2.5 lp/mm	> 40 % @ 1 lp/mm > 8 % @ 2.5 lp/mm
DQE	> 60 % @ ~0 lp/mm	> 70 % @ ~0 lp/mm
Dynamic Range	> 80 dB	> 70 dB

15.3 Electrical Specifications

Item	Description
Power supply voltage	100 - 240 V ~
Frequency	50 / 60 Hz
Power rating	2.0 kVA
Accuracy	Tube Voltage (kVp) \pm 10 %, Tube Current (mA) \pm 20 %, Exposure Time (s) \pm (5 % + 50 ms)

- The input line voltage depends on the local electrical distribution system.
- Allowable input voltage fluctuation requirement: \pm 10 %.
- Mode of operation: non-continuous operation (NFPA 70: long time operation) - needs waiting time (at least 60 times the exposure time) before the next exposure begins.
- Column operation time: Max. 2 min. On / 18 min. Off (Ratio 1:9)

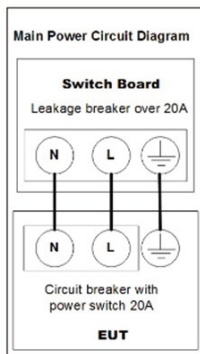
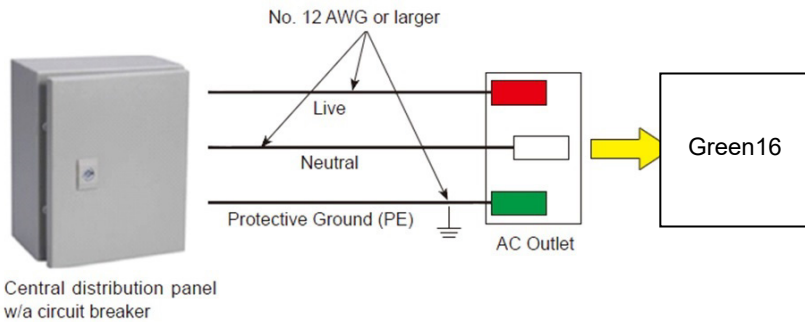

NOTICE

- A separate 3-core grounded power cable connected directly to the central distribution panel with an over-current circuit breaker rated for 20A must be used to assure line voltage quality.
- Maximally allowed deviation of the tube voltage/tube current/exposure time:
Tube Voltage (kVp) $\pm 10\%$ / Tube Current (mA) $\pm 20\%$ / Exposure Time (s) $\pm (5\% + 50\text{ ms})$ according to IEC 60601-2-63.
- The mains resistance should not exceed 0.045 ohms at 100 V and 0.19 ohm at 240 V.

15.4 Environmental Specifications

	Item	Description
During Operation	Temperature	10 ~ 35 °C
	Relative humidity	30 ~ 75 %
	Atmospheric pressure	860 ~ 1060 hPa
During Transport and Storage	Temperature	-10 ~ 60 °C
	Relative humidity	10 ~ 75 %
	Atmospheric pressure	860 ~ 1060 hPa

This Page Intentionally Left Blank

16. Appendices

16.1 Recommended X-ray Exposure Tables

16.1.1 PANO Mode

Exposure Condition

Mode	Image Option	Gender / Age group	X-ray Intensity	Tube Voltage (kVp)	Tube Current (mA)
PANO Examination	High Resolution	Man	Hard	75	12
			Normal	74	12
			Soft	73	12
		Woman	Hard	74	12
			Normal	73	12
			Soft	72	12
		Child	Hard	68	10
			Normal	67	10
			Soft	66	10
	Green (Optional)	Man	Hard	75	14
			Normal	74	14
			Soft	73	14
		Woman	Hard	74	14
			Normal	73	14
			Soft	72	14
Child		Hard	68	12	
		Normal	67	12	
		Soft	66	12	
PANO Examination (Insight PAN) (Optional)	High Resolution	Man & Woman	Normal	70	7
		Child	Normal	67	7
SPECIAL Examination	N/A	Man	Hard	75	14
			Normal	74	14
			Soft	73	14
		Woman	Hard	74	14
			Normal	73	14
			Soft	72	14
		Child	Hard	68	12
			Normal	67	12
			Soft	66	12

Scan Time / Exposure Time

Examination Mode	Arch Type	Examination Mode	High Resolution		Green (Optional)		
			Scan Time (s)	Exposure Time (s)	Scan Time (s)	Exposure Time (s)	
PANO Examination	Narrow	Standard	14.1	13.5	7.0	7.0	
		Right	14.1	6.8	7.0	3.5	
		Front	14.1	11.3	7.0	5.8	
		Left	14.1	6.8	7.0	3.5	
	Normal	Standard	14.1	13.5	7.0	7.0	
		Right	14.1	6.8	7.0	3.5	
		Front	14.1	11.3	7.0	5.8	
		Left	14.1	6.8	7.0	3.5	
	Wide	Standard	14.1	13.5	7.0	7.0	
		Right	14.1	6.8	7.0	3.5	
		Front	14.1	11.3	7.0	5.8	
		Left	14.1	6.8	7.0	3.5	
	Child	Standard	12.0	11.5	6.8	6.7	
		Right	12.0	5.7	6.8	3.3	
		Front	12.0	9.2	6.8	5.2	
		Left	12.0	5.7	6.8	3.3	
	Orthogonal	Standard	14.1	13.5	7.0	7.0	
		Right	14.1	6.7	7.0	3.5	
		Front	14.1	11.1	7.0	5.7	
		Left	14.1	6.7	7.0	3.5	
		Bitewing	14.1	9.2	7.0	5.0	
		Bitewing Incisor (Optional)	14.1	2.8	7.0	1.4	
		Bitewing Right	14.1	5.0	7.0	2.8	
		Bitewing Left	14.1	5.0	7.0	2.8	
	SPECIAL Examination	-	TMJ LAT Open	14.1	6.7	14.1	6.7
			TMJ LAT Close				

Examination Mode	Arch Type	Examination Mode	High Resolution		Green (Optional)	
			Scan Time (s)	Exposure Time (s)	Scan Time (s)	Exposure Time (s)
		TMJ PA Open (Optional)	10.0	6.1	10.0	6.1
		TMJ PA Close (Optional)				
		Sinus LAT (Optional)	4.0	3.7	4.0	3.7
		Sinus PA	8.8	7.7	8.8	7.7

- Scan Time: The actual time that the equipment shoots the patient except for the initial acceleration and late deceleration stages.
- Exposure Time: The actual time the patient is exposed to the X-ray emission.

16.1.2 CEPH Mode

Exposure Condition

Examination Program	Image Option	Gender / Age group	X-ray Intensity	Tube Voltage (kVp)	Tube Current (mA)
Lateral	High Resolution	Man	Hard	92	15.0
			Normal	90	15.0
			Soft	88	15.0
		Woman	Hard	90	15.0
			Normal	88	15.0
			Soft	86	15.0
		Child	Hard	88	15.0
			Normal	86	15.0
			Soft	84	15.0
	Green	Man	Hard	92	16.0
			Normal	90	16.0
			Soft	88	16.0
		Woman	Hard	90	16.0
			Normal	88	16.0
			Soft	86	16.0
Child		Hard	88	16.0	
		Normal	86	16.0	
		Soft	84	16.0	
Full Lateral (Optional)	High Resolution / Green	Man	Hard	92	14.0
			Normal	90	14.0
			Soft	88	14.0
		Woman	Hard	90	14.0
			Normal	88	14.0
			Soft	86	14.0
		Child	Hard	88	14.0
			Normal	86	14.0
			Soft	84	14.0

Examination Program	Image Option	Gender / Age group	X-ray Intensity	Tube Voltage (kVp)	Tube Current (mA)
PA SMV Waters' view	High Resolution	Man	Hard	92	14.0
			Normal	90	14.0
			Soft	88	14.0
		Woman	Hard	90	14.0
			Normal	88	14.0
			Soft	86	14.0
		Child	Hard	88	14.0
			Normal	86	14.0
			Soft	84	14.0
	Green	Man	Hard	92	15.0
			Normal	90	15.0
			Soft	88	15.0
		Woman	Hard	90	15.0
			Normal	88	15.0
			Soft	86	15.0
		Child	Hard	88	15.0
			Normal	86	15.0
			Soft	84	15.0
Carpus	High Resolution / Green	Man	Hard	90	6.0
			Normal	88	6.0
			Soft	86	6.0
		Woman	Hard	88	6.0
			Normal	86	6.0
			Soft	84	6.0
		Child	Hard	86	6.0
			Normal	84	6.0
			Soft	82	6.0

Scan Time / Exposure Time

Examination Program	High Resolution		Green	
	Scan Time (s)	Exposure Time (s)	Scan Time (s)	Exposure Time (s)
Lateral	3.9	3.9	1.9	1.9
Full Lateral (Optional)	5.4	5.4	3.9	3.9
PA	4.9	4.9	2.4	2.4
SMV	4.9	4.9	2.4	2.4
Waters' view	4.9	4.9	2.4	2.4
Carpus	4.9	4.9	2.4	2.4

- Scan Time: The actual time that the equipment shoots the patient except for the initial acceleration and late deceleration stages.
- Exposure Time: The actual time the patient is exposed to the X-ray emission.

16.1.3 CBCT Mode

Exposure Area

FOV (cm)	Vertical Position	Horizontal Position		
		Right	Center	Left
16x9	Occlusion	X	O	X
12x9	Occlusion	X	O	X
	TMJ	O	X	O
	Airway	X	O	X
8x9	Occlusion	O	O	O
	TMJ	O	X	O
8x5	Maxilla / Mandible	O	O	O
5x5	Maxilla / Mandible	Right Molar / Right / Incisor / Left / Left Molar		
Double scan (Optional)	First Exposure: Mandible Second Exposure: Maxilla	X		

Exposure Condition

FOV (cm)	Image Option	Gender / Age Group	X-ray Intensity	Tube Voltage (kVp)	Tube Current (mA)
16x9 & 12x9 & Double scan (Optional)	High Resolution	Man	Hard	95	8.0
			Normal	94	8.0
			Soft	93	8.0
		Woman	Hard	95	7.7
			Normal	94	7.7
			Soft	93	7.7
		Child	Hard	95	7.4
			Normal	94	7.4
			Soft	93	7.4
	Green	Man	Hard	88	6.1
			Normal	87	6.1
			Soft	86	6.1
Woman		Hard	88	5.8	
		Normal	87	5.8	

FOV (cm)	Image Option	Gender / Age Group	X-ray Intensity	Tube Voltage (kVp)	Tube Current (mA)	
8x9, 8x5, 5x5.		Child	Soft	86	5.8	
			Hard	88	5.5	
			Normal	87	5.5	
					Soft	86
	8x9, 8x5, 5x5.	High Resolution	Man	Hard	95	8.0
				Normal	94	8.0
				Soft	93	8.0
			Woman	Hard	95	7.7
				Normal	94	7.7
				Soft	93	7.7
			Child	Hard	95	7.4
				Normal	94	7.4
Soft				93	7.4	
Green		Man	Hard	88	6.1	
			Normal	87	6.1	
			Soft	86	6.1	
	Woman	Hard	88	5.8		
		Normal	87	5.8		
		Soft	86	5.8		
	Child	Hard	88	5.5		
		Normal	87	5.5		
		Soft	86	5.5		

Scan Time / Exposure Time

FOV (cm)	Scan Time (s) (High Resolution / Green)	Exposure Time (s) (High Resolution / Green)
16x9	9.0	9.0
12x9	9.0	9.0
8x9	4.9	4.9
8x5	4.9	4.9
5x5	4.9	4.9
Double scan (Optional)	18.0	18.0

- Scan Time: The actual time that the equipment shoots the patient except for the initial acceleration and late deceleration stages.
- Exposure Time: The actual time the patient is exposed to the X-ray emission.

Reconstruction Time / File Size (Measured Object: Skull)

FOV (cm)	Voxel Size (mm)	Reconstruction Time (s)		File Size (MB)
		Fast	HD	
Double scan (Optional)	0.3	60	-	282
16x9	0.2	22	145	550
	0.3	15	78	163
12x9	0.2	16	101	309
	0.3	13	58	92
8x9	0.12	18	160	635
	0.2	11	56	138
8x5	0.12	12	98	359
	0.2	9	37	77
5x5	0.08	18	114	466
	0.12	8	44	138

- The above data is obtained from a computer system based on Intel E5-1607 v3@3.10GHz (16GB of RAM) and NVIDIA GeForce GTX1060 6GB.
- Image reconstruction time varies depending on computer specifications and working conditions.

16.1.4 3D MODEL Scan Mode

Exposure Area

FOV (cm)	MODEL Type	Horizontal Position		
		Right	Center	Left
8x9	Upper (Maxilla)	X	O	X
	Lower (Mandible)	X	O	X

Exposure Condition

FOV (cm)	Gender / Age Group	X-ray Intensity	Tube Voltage (kVp)	Tube Current (mA)
8x9	Man / Woman / Child	Hard / Normal / Soft	95	8.0

Scan Time / Exposure Time

FOV (cm)	Scan Time (s)	Exposure Time (s)
8x9	9.0	9.0

- Scan Time: The actual time that the equipment shoots the plaster cast except for the initial acceleration and late deceleration stages.
- Exposure Time: The actual time that the plaster cast is exposed to the X-ray emission.

Reconstruction Time / File Size

FOV (cm)	Voxel Size (mm)	Reconstruction Time (s)	File Size (MB)
8x9	0.12	269	635

- The above data is obtained from a computer system based on Intel i7-6700 and NVIDIA GeForce GTX1060 6GB.
- Image reconstruction time varies depending on computer specifications and working conditions.

16.2 X-ray Dose Data

16.2.1 DAP (Dose Area Product)

The X-ray dose data is extracted from the X-ray Dose Test Report for **Green 16 (PHT-65LHS)**.

X-ray Dose Test Report for the **Green 16 (PHT-65LHS)** maintains dosimetric evaluation that the **VATECH** dental diagnostic system meets all requirements specified in the IEC Collateral Standard. To limit unnecessary exposure to the patient, operator, or other staff, **Green 16 (PHT-65LHS)** is designed to comply with IEC 60601-1-3 Part 1 General Requirements for Safety.

Test Hardware	
Brand Name (Model)	Green 16 (PHT-65LHS)
Sensor Type	PANO & CBCT: Xmaru1314CF CEPH: Xmaru2602CF
X-ray Generator	DG-07E22T2
Tube	D-052SB

DAP (Dose Area Product) is a quantity used in assessing the radiation risk from diagnostic X-ray examination procedures. It is defined as the absorbed dose multiplied by the area irradiated, expressed in gray square centimeters ($\text{mGy}\cdot\text{cm}^2$). Despite the limitation, DAP is the best way to predict effective dose value and is currently the most convenient method for patient dose monitoring.

- *PHE (Public Health England) recommends that any national reference dose that achievable dose (DAP) value of 250 [$\text{mGy}\cdot\text{cm}^2$] for a clinical protocol for a standard male patient.*

DAP (Dose Area Product) Calculation

$$\text{DAP}[\text{mGy} \cdot \text{cm}^2] = \text{Dose}[\text{mGy}] \times \text{Exposed Area}[\text{cm}^2]$$

NOTICE

When you need more information on DAP measurement procedures or test results for the equipment, please contact **VATECH** service center or your local **VATECH** representative and get assistance from **VATECH**-authorized technicians

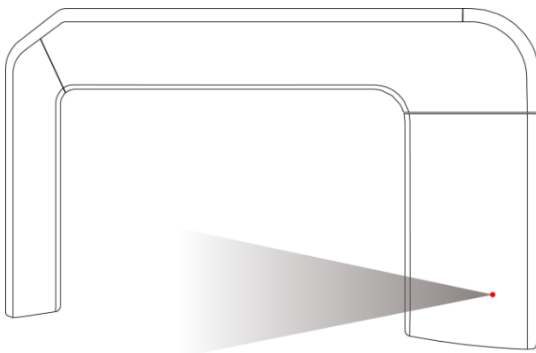
Measurement Overview**Results**

Mode	Exposure Condition	DAP [mGy·cm ²]
PANO Adult Man Normal (High Resolution)	74 kVp / 12.0 mA / 13.5 s	110
PANO Child Normal (High Resolution)	67 kVp / 10.0 mA / 11.5 s	55
PANO Adult Man Normal (Green)	74 kVp / 14.0 mA / 7.0 s	65
PANO Child Normal (Green)	67 kVp / 12.0 mA / 6.7 s	35
CEPH Adult Man LAT (High Resolution)	90 kVp / 15.0 mA / 3.9 s	41
CEPH Child LAT (High Resolution)	86 kVp / 10.0 mA / 3.9 s	38
CEPH Adult Man LAT (Green)	90 kVp / 16.0 mA / 1.9 s	25
CEPH Child LAT (Green)	86 kVp / 16.0 mA / 1.9 s	23
CBCT 16x9 Adult Man (High Resolution)	94 kVp / 8.0 mA / 9.0 s	1435
CBCT 16x9 Adult Man (Green)	87 kVp / 6.1 mA / 9.0 s	913
CBCT 12x9 Adult Man (High Resolution)	94 kVp / 8.0 mA / 9.0 s	1147
CBCT 12x9 Adult Man (Green)	87 kVp / 6.1 mA / 9.0 s	730

Mode	Exposure Condition	DAP [mGy·cm ²]
CBCT 8x9 Adult Man (High Resolution)	94 kVp / 8.0 mA / 4.9 s	802
CBCT 8x9 Adult Man (Green)	87 kVp / 6.1 mA / 4.9 s	510
CBCT 8x5 Maxilla/Mandible (High Resolution)	94 kVp / 8.0 mA / 4.9 s	490
CBCT 8x5 Maxilla/Mandible (Green)	94 kVp / 8.0 mA / 4.9 s	307
CBCT 5x5 Maxilla Adult Man (High Resolution)	94 kVp / 8.0 mA / 4.9 s	331
CBCT 5x5 Maxilla Adult Man (Green)	87 kVp / 6.1 mA / 4.9 s	211
CBCT 5x5 Mandible Adult Man (High Resolution)	94 kVp / 8.0 mA / 4.9 s	331
CBCT 5x5 Mandible Adult Man (Green)	87 kVp / 6.1 mA / 4.9 s	211
CBCT Double Scan Adult Man (High Resolution) (Optional)	94 kVp / 8.0 mA / 9.0 s	2870
CBCT Double Scan Adult Man (Green) (Optional)	87 kVp / 6.1 mA / 9.0 s	1826

- In Double Scan mode, exposure the FOV 16x9 twice, then stitch the acquired images to provide one image.

16.2.2 Leakage Dose

X-ray Leakage Dose Test is performed to protect patients against excessive and unnecessary radiation that is not purposed, and this document evaluates the leakage dose amount based on the following standard defined by IEC regulation. It has been performed by covering each collimator region in use.

Standard

National Deviation	Terminology	Permissive Range
International Standard IEC 60601-1-3	Leakage	limits leakage at 1M from the source to 100 mR in 1hr

Measurement Overview

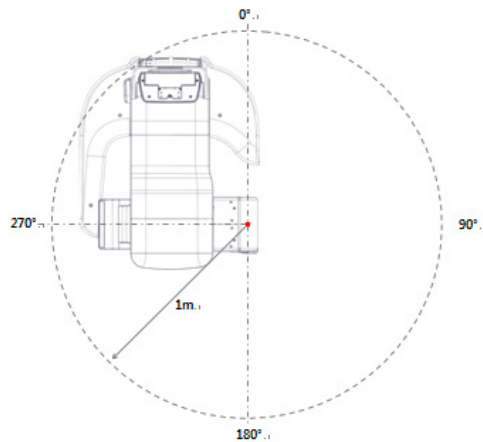

Test Condition

Test mode	Tube Voltage (kVp)	Tube Current (mA)	Exposure Time (s)
PANO Adult Man Normal (High Resolution)	99	14.0	13.5
CEPH Adult Man LAT (High Resolution)	99	16.0	3.9
CBCT16x9 Adult Man (High Resolution)	99	12.0	9.0

- In Double Scan mode, exposure the FOV 16x9 twice, then stitch the acquired images to provide one image.

Results

Direction [°]	PANO Adult Man Normal (High Resolution) [mR/h]	CEPH Adult Man LAT (High Resolution) [mR/h]	CBCT 16x9 Adult Man (High Resolution) [mR/h]
0	7.3	5.4	14.6
45	5.8	4.5	8.3
90	1.1	2.8	4.8
135	3.5	4.5	5.2
180	10.5	21.0	11.7
225	22.4	11.8	33.5
270	6.8	18.5	7.4
315	24.5	5.5	48.7

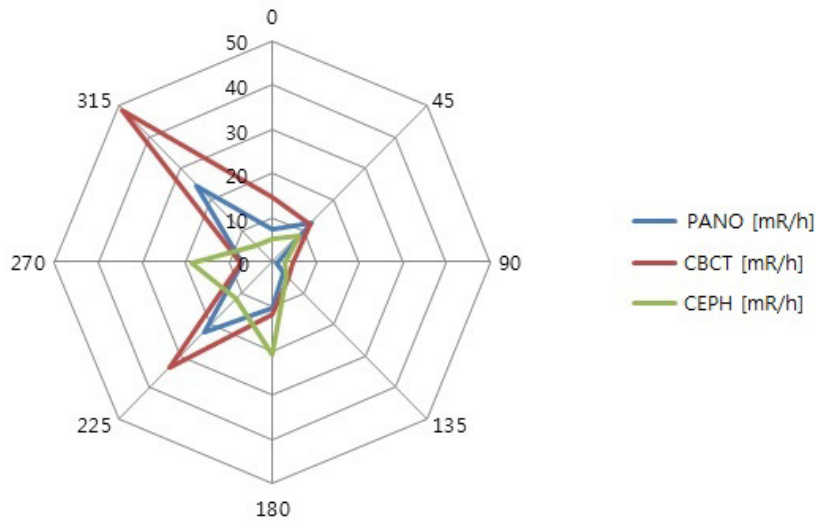

16.2.3 Scattered Dose

X-ray Scattered Dose data concerning different angles and distances are examined for recommendations about appropriate radiation level insignificant zones of occupancy, and the effectiveness of protective shielding facility around the patient's position. This information states the identity and intended position of the tested phantom and scattered dosimetric evaluation under the defined scope and test circumstances to ensure the magnitude of risks to the operator and staff during both accident situations and routine work.

Measurement Overview

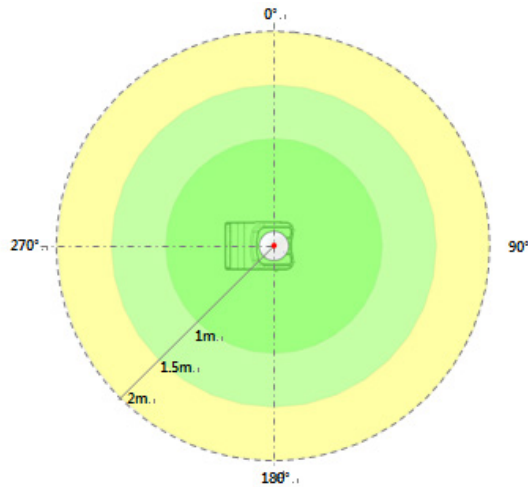

Test Condition

Test mode	Tube Voltage (kVp)	Tube Current (mA)	Exposure Time (s)
PANO Adult Man Normal (High Resolution)	99	14.0	13.5
CBCT 16x9 Adult Man (High Resolution)	99	12.0	9.0
CEPH Adult Man LAT (High Resolution)	99	16.0	3.9

- In Double Scan mode, exposure the FOV 16x9 twice, then stitch the acquired images to provide one image.

Results

■ (PANO / Adult, Man / Normal / High Resolution)

Direction [°]	1 m [mR]	1.5 m [mR]	2 m [mR]
0	0.079	0.049	0.021
45	0.039	0.025	0.016
90	0.079	0.050	0.020
135	0.050	0.032	0.013
180	0.162	0.085	0.034
225	0.175	0.082	0.035
270	0.272	0.077	0.031
315	0.224	0.066	0.030

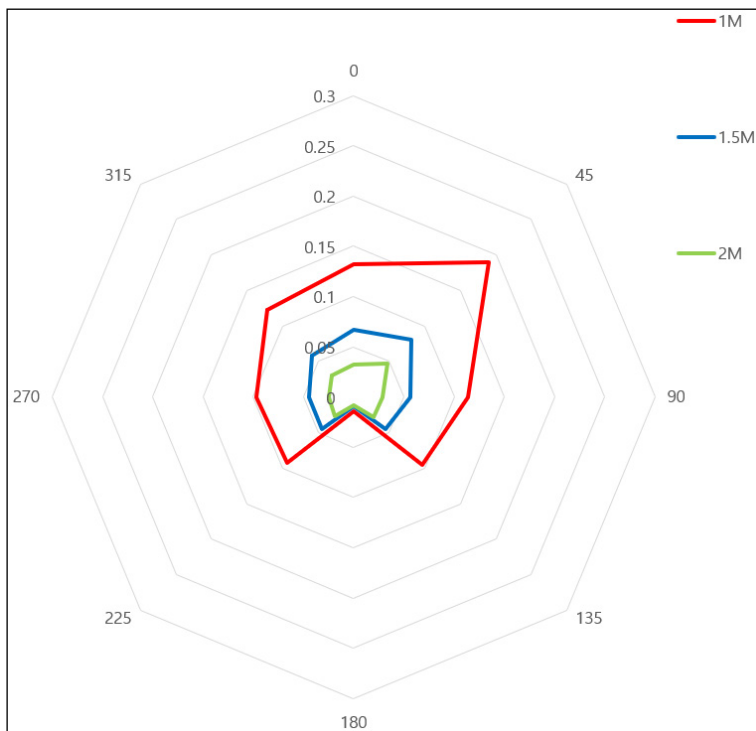

■ CBCT / 16x9 / Adult, Man / High Resolution

Direction [°]	1 m [mR]	1.5 m [mR]	2 m [mR]
0	1.727	0.971	0.482
45	1.817	0.952	0.499
90	0.656	0.170	0.044
135	2.392	1.121	0.525
180	2.541	1.104	0.480
225	2.399	1.095	0.500
270	2.415	1.185	0.581
315	1.874	0.936	0.467

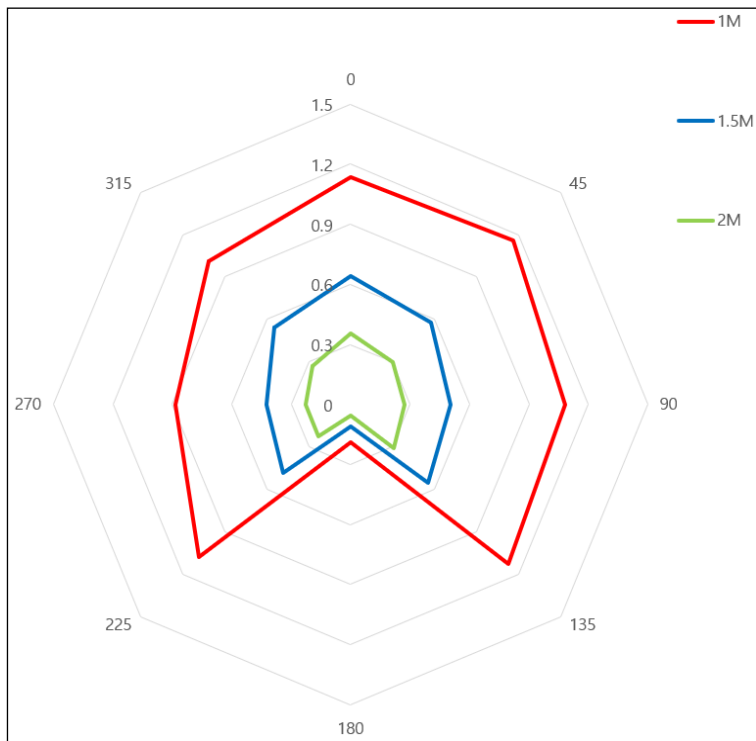

■ CEPH / Full Lateral / Adult, Man / High Resolution

Direction [°]	1 m [mR]	1.5 m [mR]	2 m [mR]
0	0.031	0.021	0.012
45	0.013	0.009	0.003
90	0.011	0.007	0.004
135	0.033	0.006	0.004
180	0.025	0.013	0.004
225	0.045	0.034	0.019
270	-	-	0.022
315	0.073	0.048	0.025

- Data of 1 m and 1.5 m at 270 ° are not measured since the Ion chamber is located between the generator and the object.



16.3 Electromagnetic Compatibility (EMC) Information

Guidance and manufacturer's declaration - electromagnetic emissions

The **PHT-65LHS** is intended for use in the electromagnetic environment specified below. The customer or the user of the **PHT-65LHS** should assure that it is used in such an environment.

Immunity test	Compliance	Electromagnetic environment - Guidance
RF emissions CISPR 11	Group 1	The PHT-65LHS uses RF energy only for its internal function. Therefore, its RF emissions are very low and are not likely to cause any interference in nearby electronic equipment.
RF emissions CISPR 11	Class A	The PHT-65LHS is suitable for use in all establishments other than domestic and may be used in domestic establishments and those directly connected to the public low-voltage power supply network that supplies buildings used for domestic purposes, provided the following warning is heeded:
Harmonic emissions IEC 61000-3-2	Class A	
Voltage fluctuations / flicker emissions IEC 61000-3-3	Complies	<p>Warning: This equipment/system is intended for healthcare professionals only. This equipment/ system may cause radio interference or may disrupt the operation of nearby equipment. It may be necessary to take mitigation measures, such as re-orienting or relocating the PHT-65LHS or shielding the location.</p>

NOTE) the actual RF shielding effectiveness and filter attenuation of the shielded location must be verified to ensure they meet or exceed the specified minimum values.

Guidance and manufacturer's declaration - electromagnetic immunity

The **PHT-65LHS** is intended for use in the electromagnetic environment specified below. The customer or the user of the **PHT-65LHS** should assure that it is used in such an environment.

Immunity test	IEC 60601-1-2 Test level	Compliance level	Electromagnetic environment - Guidance
Electrostatic discharge (ESD) IEC 61000-4-2	± 8 kV Contact ± 2 kV, ± 4 kV, ± 8 kV, ±15 kV air	± 8 kV Contact ± 2 kV, ± 4 kV, ± 8 kV, ±15 kV air	Floors should be wood, concrete, or ceramic tile. If floors are covered with synthetic material, the relative humidity should be at least 30%.
Electrical fast transient/burst IEC 61000-4-4	±2 kV for power supply lines ±1 kV for input/output lines	±2 kV for power supply lines ±1 kV for input/output lines	The main power quality should be a typical commercial or hospital environment.
Surge IEC 61000-4-5	±1 kV line(s) to line(s) ±2 kV line(s) to earth	±1 kV line(s) to line(s) ±2 kV line(s) to earth	The main power quality should be a typical commercial or hospital environment.
Voltage dips, short interruptions and voltage variations on power supply input lines IEC 61000-4-11	0 % U_T : 0.5 cycle At 0°, 45°, 90°, 135°, 180°, 225°, 270° and 315° 0 % U_T : 1 cycle and 70 % U_T : 25/30 cycles Single-phase: at 0°	0 % U_T : 0.5 cycle At 0°, 45°, 90°, 135°, 180°, 225°, 270° and 315° 0 % U_T : 1 cycle and 70 % U_T : 25/30 cycles Single-phase: at 0°	The main power quality should be a typical commercial or hospital environment. If the user of the PHT-65LHS image intensifier requires continued operation during main power interruptions, it is recommended that the PHT-65LHS image intensifier be powered from an uninterruptible power supply or a battery.
Power frequency (50/60 Hz) magnetic field IEC 61000-4-8	30 A/m 50 Hz/60 Hz	30 A/m 50 Hz/60 Hz	Power frequency magnetic fields should be at levels characteristic of a typical location in a typical commercial or hospital environment.

NOTE U_T is the a.c. Mains voltage before application of the test level.

Guidance and manufacturer's declaration - electromagnetic immunity

The **PHT-65LHS** is intended for use in the electromagnetic environment specified below. The customer or the user of the **PHT-65LHS** should assure that it is used in such an environment.

Immunity test	IEC 60601-1-2 Test level	Compliance level	Electromagnetic environment - Guidance
Conducted RF IEC 61000-4-6	3 Vrms 150 kHz to 80MHz	$V_1=3V_{rms}$	Portable and mobile RF communications equipment should be used no closer to any part of the PHT-65LHS , including cables, than the recommended separation distance calculated from the equation applicable to the transmitter's frequency. Recommended separation distance: $d = \left[\frac{3,5}{V_1} \right] \sqrt{P}$ $d = \left[\frac{3,5}{E_1} \right] \sqrt{P} \quad 80 \text{ MHz to } 800 \text{ MHz}$ $d = \left[\frac{7}{E_1} \right] \sqrt{P} \quad 800 \text{ MHz to } 2,5 \text{ GHz}$ <p>Where P is the maximum output power rating of the transmitter in watts(W) according to the transmitter manufacturer, and d is the recommended separation distance in meters(m).</p> <p>Field strengths from fixed RF transmitters, as determined by an electromagnetic site survey, should be less than the compliance level in each frequency range. ^b</p> <p>Interference may occur in the vicinity of the equipment marked with the following symbol:</p> 
Radiated RF IEC 61000-4-3	3 V/m 80 MHz to 2.7 GHz	$E_1=3V/m$	

NOTE 1) At 80MHz and 800MHz, the higher frequency range applies.

NOTE 2) These guidelines may not apply in all situations. Electromagnetic propagation is affected by absorption and reflection from structures, objects, and people.

The **PHT-65LHS** is intended for use in the electromagnetic environment specified below. The customer or the user of the **PHT-65LHS** should assure that it is used in such an environment.

Field strengths from fixed transmitters, such as base stations for radio (cellular/cordless) telephones and land mobile radios, amateur radio, AM and FM radio broadcasts, and TV broadcasts, cannot be predicted theoretically with accuracy. To assess the electromagnetic environment due to fixed RF transmitters, an electromagnetic site survey should be considered. If the measured field strength in the location where the **PHT-65LHS** is used exceeds the applicable RF compliance level above, the **PHT-65LHS** should be observed to verify normal operation. If abnormal performance is observed, additional measures may be necessary, such as re-orienting or relocating the **PHT-65LHS**.

^b Over the frequency range 150kHz to 80MHz, field strengths should be less than $[V_1]$ V/m.

Recommended separation distances between portable and mobile RF communications equipment and the PHT-65LHS

This is intended for use in an electromagnetic environment in which radiated RF disturbances are controlled. The customer or the user of the **PHT-65LHS** can help Prevent electromagnetic interference by maintaining a minimum distance between portable and mobile RF communications equipment (transmitters) and the **PHT-65LHS** as recommended below, according to the maximum output power of the communications equipment.

Separation distance according to the frequency of transmitter [m]

IEC 60601-1-2

Frequency of Transmitter	150kHz to 80MHz	80MHz to 800MHz	800MHz to 2.7GHz
Equation	$d = \left[\frac{3,5}{V_1}\right]\sqrt{P}$	$d = \left[\frac{3,5}{E_1}\right]\sqrt{P}$	$d = \left[\frac{7}{E_1}\right]\sqrt{P}$
The rated maximum output power of the transmitter [W]	$V_1=3V_{rms}$	$E_1=3V/m$	$E_1=3V/m$
	Separation Distance (meters)	Separation Distance (meters)	Separation Distance (meters)
0.01	0.116	0.1166	0.2333
0.1	0.368	0.3687	0.7378
1	1.166	1.1660	2.3333
10	3.687	3.6872	7.3785
100	11.660	11.6600	23.333

This is intended for use in an electromagnetic environment in which radiated RF disturbances are controlled. The customer or the user of the **PHT-65LHS** can help Prevent electromagnetic interference by maintaining a minimum distance between portable and mobile RF communications equipment (transmitters) and the **PHT-65LHS** as recommended below, according to the maximum output power of the communications equipment.

For transmitters rated at a maximum output power not listed above, the recommended separation distance d in meters (m) can be estimated using the equation applicable to the frequency of the transmitter, where p is the maximum output power rating of the transmitter in watts (W) according to the transmitter manufacturer.

NOTE 1) At 80MHz and 800MHz, the separation distance for the higher frequency range applies.

NOTE 2) These guidelines may not apply in all situations. Electromagnetic propagation is affected by absorption and reflection from structures, objects, and people.

a. Field strength from fixed transmitters, such as base stations for radio (cellular/cordless) telephones and land mobile radios, amateur radio, AM and FM radio broadcasts, and TV broadcasts cannot be predicted theoretically with accuracy. To assess the electromagnetic environment due to fixed RF transmitters, an electromagnetic site survey should be considered. If the measured field strength in the location in which the **PHT-65LHS** is used exceeds the applicable RF compliance level above, the **PHT-65LHS** should be observed to verify normal operation. If abnormal performance is observed, additional measures may be necessary, such as re-orienting or relocating the **PHT-65LHS**

b. Over the frequency range 150kHz to 80MHz, field strengths should be less than $[V_1]$ V/m.

Immunity and Compliance Level

Immunity test	IEC 60601-1-2 Test level	Actual Immunity Level	Compliance Level
Conducted RF IEC 61000-4-6	3Vrms 150kHz to 80MHz	3Vrms	3Vrms
Radiated RF IEC 61000-4-3	3Vrms 80MHz to 2.7GHz	3V/m	3V/m

16.4 Hand-wrist Image Evaluation References

Radiographic Evaluation of Skeletal Maturation. A clinically oriented method based on hand-wrist films.

Fishman LS. 1982

The system of Skeletal Maturation Assessment (SMA)

The System uses only four stages of bone maturation. All were found at six anatomical sites located on the thumb, third finger, fifth finger, and radius, as seen in Fig.1. Eleven discrete adolescent skeletal maturational indicators (SMI's), covering the entire period of adolescent development, are found on these six sites (See Fig.1).

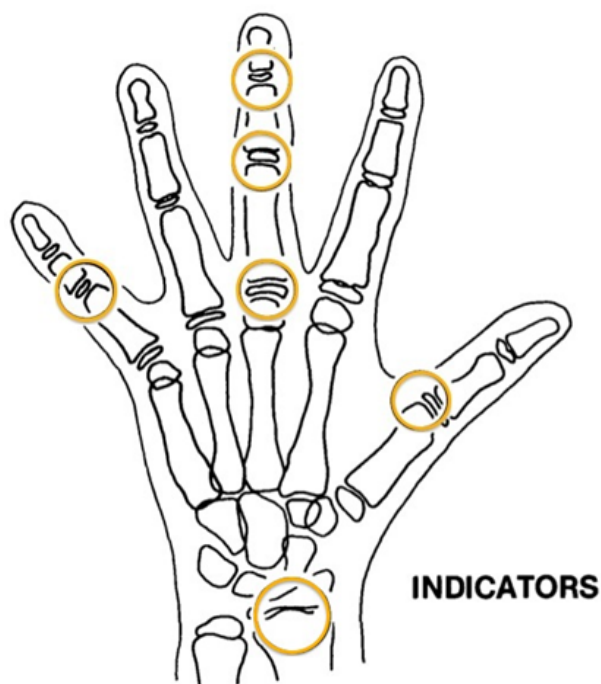

[Fig1. The site of skeletal maturity indicators]

Skeletal Maturity Indicators (SMI)

A system of skeletal maturation assessment based on four stages of bone maturation at six anatomical sites in the hand wrist.

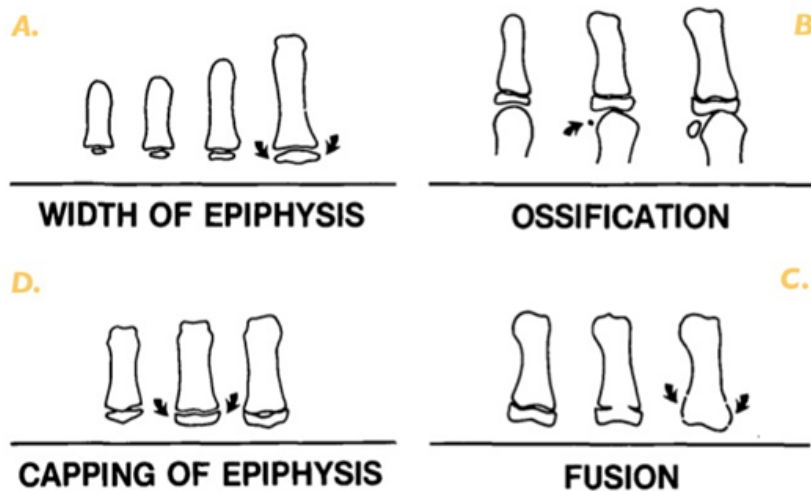

Fig. 2 Radiographic identification of skeletal maturity indicators.

- A. Epiphysis equal in width to diaphysis.
- B. Appearance of adductor sesamoid of the thumb.
- C. Capping of epiphysis.
- D. Fusion of epiphysis.

[Fig2. Radiographic identification of skeletal maturity indicators]

A. The width of the epiphysis as wide as the diaphysis

1. Third finger – a Proximal phalanx
2. Third finger – a middle phalanx
3. Fifth finger – a middle phalanx

B. Ossification

1. Adductor sesamoid of thumb

C. Capping of epiphysis

1. Third finger – a distal phalanx
2. Third finger – a middle phalanx
3. Fifth finger – a middle phalanx

D. Fusion

1. Third finger – a distal phalanx
2. Third finger – a proximal phalanx
3. Third finger – a middle phalanx
4. Radius

Eleven Skeletal maturity indicators (SMIs)

The System uses only four stages of bone maturation. All were found at six anatomical sites located on the thumb, third finger, fifth finger, and radius, as seen in Fig.1. Eleven discrete adolescent skeletal maturational indicators (SMI's), covering the entire period of adolescent development, are found on these six sites (See Fig 1.).

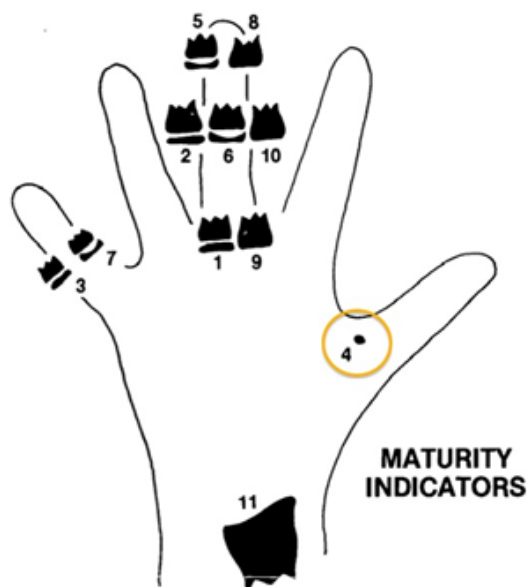

[Fig3. Eleven Skeletal maturity indicators (SMIs)]

A systematic observational scheme, such as that shown in the figure above, can further facilitate SMI evaluation. With this approach, key stages are checked first, rather than looking for maturity indicators in numerical order. A useful step is to determine if the adductor sesamoid of the thumb can be seen (orange circle). If not, then the applicable SMI will be one of those associated with early epiphyseal widening rather than capping. If the sesamoid is visible, then either the sesamoid or an SMI based on capping or fusion will be applicable.

HAND-WRIST OBSERVATION SCHEME

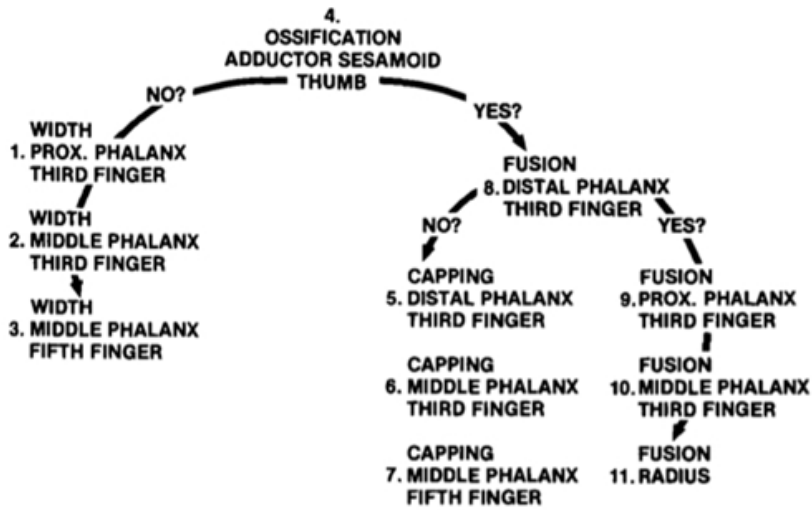

16.5 Acquiring Images for Pediatric Dental Patients

16.5.1 Age Group: Classification Table

Ages are classified loosely into the following correspondence between the FDA definition and the one used in this manual.

Age Group	FDA's standard	VATECH's Standard
Infant	1 month to 2 years	N/A
Child	2 ~ 12 years of age	Child
Adolescent	12 ~16 years of age	Adult
Other	16 ~ 21 years of age	
Adult	> 21 years of age	

16.5.2 Positioning the Pediatric Dental Patients

1. Use a laser light beam guide to locate the midsagittal plane. The direct patient focuses on mirroring reflection. Affix decal to mirror to aid the patient in maintaining the correct position throughout the exposure.
2. Move the Chinrest into a position that is slightly higher than the patient's chin height before requesting that the weak place chins onto the rest. Direct the patient to assume a position that resembles the erect stance of a soldier.
3. Direct the patient to stick out the chest while dropping the chin down. While holding the unit handles for stability, direct the patient to take a half step toward the vertical column of the X-ray device into a position that feels as if he/she is slightly leaning backward.
4. Direct the patient to stick out the chest while dropping the chin down. While holding the unit handles for stability, direct the patient to take a half step toward the vertical column of the X-ray device into a position that feels as if he/she is slightly leaning backward.
5. Direct the patient to close lips around the Bite Block during the exposure.
6. Direct the patient to swallow and note the flat position of the tongue. Request that the patient sucks in the cheeks, pushing the tongue into the correct flat position against the palate, and maintain this position throughout the exposure.

<How to produce error-free radiographic images for the pediatric patient>

(<http://www.dimensionsofdentalhygiene.com/print.aspx?id=3612>)

- By Evelyn M. Thomson, BSDH, MS

Panoramic radiographs are often recommended for assessing the growth and development of the pediatric patient and for evaluation of developing third molars during adolescence.¹⁻³ While the panoramic technique seems relatively straightforward, producing a diagnostic quality image of the pediatric patient requires a mastery of technical skills.⁴ Modern panoramic x-ray equipment is designed for ease of use, yet studies continue to demonstrate a high incidence of errors.⁵⁻⁷ Positioning errors may occur at an even higher rate in pediatric panoramic radiographs.⁷ The goal of the dental hygienist is to maximize the use of panoramic imagery in the assessment of the pediatric patient while minimizing the occurrence of retakes that result from the radiographic error.

Producing A Quality Panoramic Image

A quality panoramic radiograph should image all of the teeth, erupted and unerupted, in both the maxillary and mandibular arches from condyle to condyle in the horizontal dimension, and from the superior third of the orbit in the superior region to the inferior border of the mandible in the inferior region.^{8,9} The arches should appear straight or slightly U-shaped with the occlusal plane parallel to the horizontal edges of the film **(Figure 1)**. The anterior teeth must not be magnified or diminished in size, and overlapping of adjacent posterior teeth should be kept to a minimum.



Figure 1: Example of a diagnostically acceptable panoramic radiograph of an adolescent patient undergoing orthodontic intervention. (Courtesy of Jamie Mace and Will Wright of Schick Technologies Inc.)

The most critical component in producing a diagnostically acceptable panoramic image is patient positioning. All panoramic x-ray machines have guidelines to assist with positioning the dental arches within the three dimensions of the focal trough, an

area where the anatomical structures will be imaged in relative clarity. Most panoramic x-ray machines have a bite block to indicate the correct anterior-posterior position, or how far forward or back the patient should be positioned, side positioner guides for determining the correct lateral alignment, and chin rest to correctly locate the superior-inferior dimension or how far up or down the chin should be positioned.^{4,10} Panoramic x-ray machines are available with a mirror and laser light beam guide that shoots on the patient's face to illustrate various anatomical planes (**Figure 2**). Incorrectly positioning the patient in any of these three dimensions will produce unique and distinct radiographic image errors (**Table 1**).



Figure 2: Laser light beam guides that assist with determining correct patient positioning.

Table 1. Common Panoramic Positioning Errors

Error	Cause	Corrective action	Tips for pediatric patients
Anterior teeth narrow Severe posterior overlap Vertebrae superimposed over condyles	Arches positioned too far anterior	Position anterior teeth in appropriate position on bite guide. Locate appropriate position with anterior laser light guide.	Use a cotton roll to fill in missing primary teeth or partially erupted permanent teeth. Adapt adult recommendation for direction of laser light beam guide for use with primary teeth. Observe laser light beam guide on both the right and left sides.
Anterior teeth wide, blurred out of image Condyles not imaged	Arches positioned too far posterior	Locate appropriate position with anterior laser light guide.	Observe laser light beam guide on both the right and left sides.
Teeth on the right side appear narrowed, severely overlapped Teeth on the left side appear broad, poorly defined Condyles asymmetrical in width and height	Arches tipped or tilted to the right	Position the midsagittal plane perpendicular to the floor.	Use laser light beam guide to locate midsagittal plane. Direct patient focus to mirror reflection. Affix decal to mirror to aid patient in maintaining the correct position throughout exposure.
Teeth on the left side appear narrowed, severely overlapped Teeth on the right side appear broad and poorly defined Condyles asymmetrical in width and height	Arches tipped or tilted to the left	Position the midsagittal plane perpendicular to the floor.	Use laser light beam guide to locate midsagittal plane. Direct patient focus to mirror reflection. Affix decal to mirror to aid patient in maintaining the correct position throughout exposure.
Flat, downward-turned, "frown" appearance to the occlusal plane Palate appears as a widened, thick, dense radiopacity Condyles flare out off the edges of the image Anterior teeth appear wide, elongated	Arches positioned too far superior	Position the Frankfort or the canthomeatal plane parallel to the floor, or the ala-tragus line 5° down toward the floor.	Move chin rest into a position that is slightly higher than the patient's chin height before requesting that the patient place chin onto the rest. Direct the patient to assume a position that resembles the erect stance of a soldier.
Exaggerated upward curve of the occlusal plane creating a "smile" appearance Hyoid bone superimposed over the mandible Condyles tilt inward	Arches positioned too far inferior	Position the Frankfort or the canthomeatal plane parallel to the floor, or the ala-tragus line 5° down toward the floor.	Move chin rest into a position that is slightly higher than the patient's chin height before requesting that the patient place chin onto the rest. Direct the patient to assume a position that resembles the erect stance of a soldier.
Pyramid-shaped radiopacity superimposed over the anterior teeth	Patient in slumped position	Position the back and neck straight.	Direct the patient to stick out the chest while dropping the chin down. While holding the unit handles for stability, direct the patient to take a half step in toward the vertical column of the x-ray machine into a position that feels as if he/she is slightly leaning backward.
Radiolucent shadow of the commissure superimposed over the teeth, mimicking caries	Lips not closed around bite block	Position the lips around the bite block.	Direct the patient to keep the lips closed around the bite block during the exposure.
Radiolucency superimposed over the maxillary teeth apices	Tongue not placed against palate	Position the tongue flat against the roof of the mouth.	Direct the patient to swallow and note the flat position of the tongue. Request that the patient suck in the cheeks, pushing the tongue into the correct flat position against the palate and maintain this position throughout the exposure.

FEBRUARY 2009

Dimensions OF DENTAL HYGIENE

Anterior-Posterior Positioning Error

When the arches are positioned incorrectly in the anterior-posterior direction, distortion or ghosting of the anterior anatomy occurs. unerupted teeth in the anterior region may not be imaged on the radiograph if positioned outside of the focal trough. It is important to note that an error of only 3 mm to 4 mm in either direction will result in a significantly compromised image.¹¹ When the arches are positioned too far anterior, the anterior teeth will appear narrow and diminished in size. The vertebrae of the spinal column may be superimposed over the condyles at the edges of the film and, depending on the size of the child, may be superimposed over the rami of the mandible, blocking a clear view of the posterior teeth (**Figure 3**). When the arches are positioned too far posteriorly, the anterior teeth will appear broad or widened. If the position is excessively posterior, anterior teeth may be blurred entirely from the image, and the condyles may be cut off from the edges of the film.



Figure 3: Incorrect position too far anteriorly. Note the narrow anterior teeth and superimposition of the spinal column over the condyles. The radiolucency superior to the maxillary apices indicates that the tongue was not placed against the palate. An open lip line can also be detected.

To avoid these imaging errors, the anterior teeth must occlude edge-to-edge onto the designated area of the bite block. Achieving this position is easily compromised during exfoliation of primary teeth, making precise occlusion difficult when one tooth or multiple teeth are missing or partially erupted. A cotton roll may be attached to the bite block to fill in the space created by the missing tooth or teeth. Additionally, an adjustment may be necessary when using a laser light beam guide. The manufacturer's instructions for directing the laser light beam at a predetermined tooth or interproximal space usually apply to adult patients. These instructions may need to be modified for the pediatric patient with primary or mixed dentition.

Lateral Left-Right Positioning Error

When the arches are positioned incorrectly in the lateral left-right dimension, the posterior teeth on one side will appear broad or widened, while the teeth on the other side will appear narrowed or diminished in width and severely overlapped (**Figure 4**). This image distortion is like that which occurs with an incorrect anterior-posterior position. When the arches are rotated or tilted, the posterior teeth on one side move out of the focal trough to a position further away (back) from the image receptor, while the opposite side simultaneously moves closer (forward) to the image receptor. Depending on the severity of rotation or tilting, the inferior border of the mandible will appear distorted, and the condyles and rami will appear asymmetrical.



Figure 4: Incorrect lateral position tilted to the right. Note the teeth on the left are wide and poorly defined, while the teeth on the right are narrowed and severely overlapped. The inferior border of the mandible is distorted and the condyles appear asymmetrical.

To avoid imaging errors that result from incorrect lateral positioning, the midsagittal plane must be positioned perpendicular to the floor. Most panoramic x-ray machines have a head positioner and laser light beam guide, along with a mirror, to assist in determining the correct lateral head position. The pediatric patient may need additional instructions to maintain the correct position throughout the exposure.

The movement of the tube head during exposure may pique the pediatric patient's curiosity, causing the head to rotate as the eyes follow the movement of the tube head. A vertical line decal affixed to the mirror can serve as a visual aid and a focus point. An eye-catching sticker, such as those purchased from a craft store, can be adhered to the mirror in a position that aligns with the midsagittal plane. The patient can be directed to position the head so that the sticker appears at the tip of the nose and to maintain focus on this reflection throughout the exposure. Pediatric patients may find looking at themselves in the mirror entertaining and a fun way to participate in the process.⁹

Superior-Inferior (Up-Down) Positioning Error

Positioning the dental arches within the superior-inferior (up-down) dimension of the focal trough can be challenging to achieve, especially with children whose smaller size reduces the distance between the shoulders and the inferior border of the chin. When the arches are positioned incorrectly in the superior-inferior direction, the image exhibits multiple distortions, including increased overlap in the premolar regions. When the arches are positioned too far up or down, the teeth will simultaneously move into a position that is too far back or too far forward, respectively, out of the focal trough.¹¹

Positioning the arches too far superiorly produces a characteristic "frown" or flat, downward-turned appearance to the occlusal plane (**Figure 5**). The condyles flare out and off the edges of the image, and the palate appears as a widened, thick, dense radiopacity. This positioning error results in a widened appearance of the palate and obliterates the apical regions of the maxillary teeth, compromising the images of the unerupted developing dentition. As the maxillary arch tips upward, the anterior teeth tilt backward, producing the same widened appearance that results from an incorrect anterior-posterior position. Positioning the arches too far inferior produces a characteristic "smile" appearance or the upward curve of the occlusal plane, with the condyles tilting inward toward the center of the image (**Figure 6**). Depending on the severity of the downward position, the vertebrae may also curve inward and appear superimposed over the condyles, and the hyoid bone may be superimposed over the mandible blocking a clear view of the erupted and unerupted mandibular teeth.

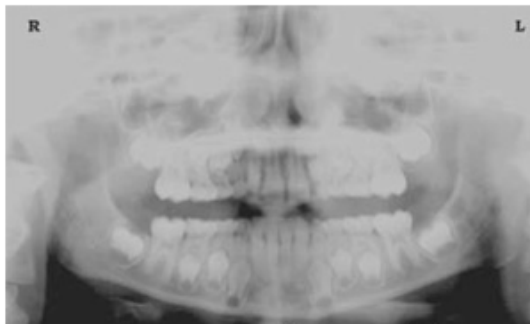

Figure 5: Chin positioned too far up. Note the characteristic "frown" or flat, downward-turned appearance to the occlusal plane. The widened palate obscures the view of the maxillary apices and the developing permanent dentition.

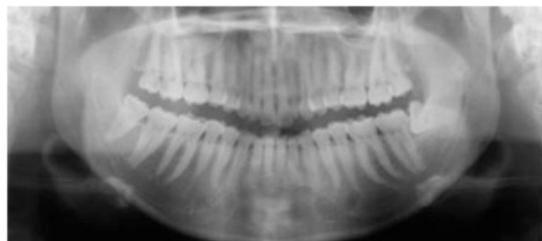

Figure 6: Chin positioned too far down. Note the characteristic “smile” or upward curved appearance to the occlusal plane and the hyoid bone superimposed over the mandible.

Correct positioning of the arches in the superior-inferior dimension requires that the patient stands with erect posture while tucking the chin in and down slightly, a direction that both adults and pediatric patients often find difficult to follow without specific guidance. The result is often a slumped position with the patient hunching the neck and shoulders over to place the chin on the chin rest. The vertebrae collapse causing attenuation of the x-ray beam that produces a triangular radiopacity superimposed over the mandible, and if severe, over the anterior maxillary regions as well.

Depending on the manufacturer, panoramic x-ray machines direct the operator to position the Frankfort or the canthomeatal plane parallel to the floor, or the ala-tragus line 5° down toward the floor. This is achieved by raising or lowering the chin rest so that the appropriate landmark lines up with indicators on the machine (**Figure 2**). The patient should be directed to stand in front of the panoramic x-ray machine allowing the operator to place the chin rest in a position that is slightly higher than the patient's chin. The patient is then requested to move into the overhead assembly of the machine and remain standing tall. If further adjustment is needed, it is usually to a lowered chin position. Once the patient's chin is resting on the chin rest, it is easier to move to a lower position than to a higher one. To assist with placing the chin on the chin rest while maintaining an erect posture, the pediatric patient can be directed to stand like a soldier. Most children are familiar with the straight back, chest forward tucked chin position demonstrated by military persons, and can readily mimic this stance.

Further Recommendations

Before beginning the exposure, the patient should be directed to close the lips around the bite block and to place the tongue against the palate. Leaving the lips open will create a soft tissue shadow across the teeth that that can be mistaken for caries.⁷ Leaving the tongue at rest during the exposure allows the radiation to easily penetrate the space of the oral cavity between the dorsal surface of the tongue and the palate,

producing a radiolucent shadow that diminishes the diagnostic quality of the radiograph (Figure 3).

"Filling in" this space with the soft tissue of the tongue can increase the quality of the image by diminishing this radiolucent shadow. When directed to place the tongue on the roof of the mouth, the pediatric patient is likely to press only the tip of the tongue against the palate. While an adult patient can usually understand what is required when directed to swallow and note the position of the tongue, a child may be directed to suck in the cheeks, which results in pushing the tongue into a position flat against the palate.⁷

Conclusion

In addition to these guidelines for producing error-free radiographic images for pediatric patients, panoramic machines should be evaluated periodically for accuracy. Changes may occur over time to the focal trough that interferes with the diagnostic quality of the machine.⁶ If a decrease in image quality is noted despite following accurate patient positioning steps, the panoramic x-ray machine should be inspected, and the focal trough recalibrated. The dental hygienist who is skilled in understanding general equipment operation and pediatric patient management is more likely to produce radiographic images that result in higher diagnostic yields.

References

1. Public Health Service, Food and Drug Administration, American Dental Association Council on Dental Benefits Program, Council on Dental Practice, Council on Scientific Affairs. *The Selection of Patients for Dental Radiographic Examinations*. Washington, DC: United States Department of Health and Human Services; 1987 (revised 2005):1-23.
2. Pinkham PS, Casamassimo, Fields HW, McTigue DJ, Nowak AJ. *Pediatric Dentistry Infancy Through Adolescence*. 4th ed. St. Louis: Elsevier Saunders; 2005:677.
3. Thomson EM. *Panoramic radiographs and the pediatric patient*. *Dimensions of Dental Hygiene*. 2008;6(2):26-29.
4. Rushton VE, Rout J. *Panoramic Radiology*. London: Quintessence Publishing Co Ltd; 2006:17, 84-85.
5. Kullman L, Joseph B. *Quality of digital panoramic radiography in a newly established dental school*. *Swedish Dent Journal*. 2006; 30: 165-170.
6. Akarslan ZZ, Erten H, Güngör K, et al. *Common errors on panoramic radiographs taken in a dental school*. *J Contemp Dent Pract*. 2003; 4:24-34.
7. Rushton VE, Horner K, Worthington HV. *The quality of panoramic radiographs in a sample of general dental practices*. *Br Dent J*. 1999; 26: 630-633.

8. White SC, Heslop EW, Hollender LG, Mosier KM, Ruprecht A, ShROUT MK. *Parameters of radiologic care: an official report of the American Academy of Oral and Maxillofacial Radiology. Oral Surg Oral Med Oral Pathol.* 2001; 91:498-511.
9. McDonald RE, Avery DR, Dean JA. *Dentistry for the Child and Adolescent. 8th ed. St. Louis: Elsevier Mosby; 2000:71-72.*
10. Johnson ON, Thomson EM. *Essentials of Dental Radiography for Dental Assistants and Hygienists. 8th ed. Upper Saddle River, NJ: Prentice-Hall 2007:388-397.*
11. Serman N, Horrell BM, Singer, S. *High-quality panoramic radiographs. Tips and tricks. Dentistry Today.* 2003;22(1):70-73.

16.5.3 Setting Exposure Values to the Age Group

For more information about this topic, refer to the Appendices **16.1 Recommended X-Ray Exposure Table**.

16.5.4 The References Pertinent to the Potential Risks for the Pediatric Patients

1) Literature

- I. ESPELID, I. MEJÅRE, K. WEERHEIJM:
EAPD guidelines for the use of radiographs in children, P40-48. *European Journal of Pediatric Dentistry* 1/2003
Guidelines in dental radiology are designed to avoid unnecessary exposure to X-radiation and to identify individuals who may benefit from a radiographic examination. Every prescription of radiographs should be based on an evaluation of the individual patient's benefit. Due to the relatively high frequency of caries among 5-year-old children, it is recommended to consider dental radiography for each child even without any visible caries or restorations. Furthermore, radiography should be considered at 8-9 years of age and then at 12-14, which is 1-2 years after the eruption of premolars and second molars. Additional bitewing controls should be based on an overall assessment of the caries activity/risk. The high-risk patient should be examined radiographically annually, while a 2-3 year interval should be considered when caries activity/risk is low. A routine survey by radiographs, except for caries, has not been shown to provide enough information to be justified considering the balance between cost (radiation and resources) and benefit.
- MICHAEL L. TAYLOR, B.SC. TOMAS KRON, PH.D., AND RICK D. FRANICH, PH.D.:

ASSESSMENT OF OUT-OF-FIELD DOSES IN RADIOTHERAPY OF BRAIN LESIONS IN CHILDREN, *Int. J. Radiation Oncology Biol. Phys.*, Vol. -, No. -, pp. 1–7, 2010 To characterize the out-of-field doses in pediatric radiotherapy and to identify simple methods by which out-of-field dose might be minimized, to reduce the risk of secondary cancers Out-of-field doses to pediatric patients can be minimized by using simple treatment

- C. THEODORAKOU, K. HORNER, K. HOWARD, A. WALKER:

Pediatric organ and effective doses in dental cone beam computed tomography Dental CBCT has been associated with higher radiation risk to the patients compared to conventional dental X-ray imaging. Several studies have investigated the radiation doses involved in dental CBCT for adults, but none has investigated pediatric doses. This study estimates the organ and effective doses to two pediatric tissue-equivalent phantoms using thermoluminescent dosimeters for three dental CBCT units and six imaging protocols. The doses to the thyroid, salivary glands and brain ranged from 0.068mSv to 1.131mSv, 0.708mSv to 2.009mSv and 0.031mSv to 1.584mSv respectively. The skin and red bone marrow have received much lower doses than the other three organs. The effective doses ranged from 0.022 mSv to 0.081 mSv. The effective doses calculated in this study were much higher than these of panoramic X-ray imaging but lower than conventional CT

- CHIYO YAMAUCHI-KAWAURA & KEISUKE FUJII & TAKAHIKO AOYAMA & SHUJI KOYAMA & MASATO YAMAUCHI:

Radiation dose evaluation in the head and neck MDCT examinations with a 6-year-old child anthropomorphic phantom, *Pediatr Radiol* (2010) 40:1206–1214 DOI 10.1007/s00247-009-1495-z

Background: CT examinations of the head and neck are the most commonly performed CT studies in children, raising concerns about radiation dose and their risks to children.

Objective: The purpose of this study was to clarify radiation dose levels for children 6 years of age undergoing head and neck multi-detector CT (MDCT) examinations.

Materials and methods: Radiation doses were measured with small-sized silicon photodiode dosimeters that were implanted at various tissue and organ positions within a standard 6-year-old anthropomorphic phantom. Organ and effective

doses of brain CT were evaluated for 19 protocols in nine hospitals on various (2–320 detector rows) MDCT scanners.

Results: The maximum value of the mean organ dose in brain CT was 34.3 mGy for the brain. Maximum values of mean doses for the radiosensitive lens and thyroid were 32.7 mGy for a lens in brain CT and 17.2 mGy for thyroid in neck CT. The seventy-fifth percentile of effective dose distribution in brain CT was approximately the same as the diagnostic reference level (DRL) in the 2003 UK survey.

2) Website

For additional information on pediatric X-ray imaging, please refer to the websites below.

- <http://www.fda.gov/radiation-emittingproducts/radiationemittingproductsandprocedures/medicalimaging/ucm298899.htm>
- <http://www.imagegently.org/>

16.6 Abbreviations

AC	Alternating Current
AF	Auto-Focusing
AMPT	Adaptive layer Mode Panoramic Tomography
CAN	Controlled Area Network
CBCT	Cone-Beam Computed Tomography
CMOS	Complementary Metal-Oxide -Semiconductor
CT	Computed Tomography
DAP	Dose Area Product
DC	Direct Current
DICOM	Digital Imaging and Communications in Medicine
EMC	Electromagnetic Compatibility
ENT	Ear, Nose, and Throat
ESD	Electrostatic Discharge
EUT	Equipment Under Test
FDD	Focal spot to Detector Distance
FOD	Focal spot to Object Distance
FOV	Field of View
FPD	Flat Panel Detector
IEC	International Electrotechnical Commission
ISO	International Standards Organization
LCD	Liquid Crystal Display
LED	Light-Emitting Diode
MAR	Metal Artifact Reduction

MPSO	Multiple Portable Socket-Outlet
ODD	Object to Detector Distance
PA	Posterior / Anterior
RF	Radio Frequency
ROI	Region of Interest
SID	Source to Image Receptor Distance
SIP	Signal Input Part
SOP	Signal Output Part
SMV	Submento-Vertical
STL	Stereo Lithography
TMJ	Temporomandibular Joint
UHD	Ultra-High Definition

This Page Intentionally Left Blank

Copyright by © 2017 VATECH Co., Ltd.

All rights reserved.

The documentation, brand name, and logo used in this manual are copyrighted.

No part of this manual may be reproduced, transmitted, or transcribed without the expressed written permission of the manufacturer.

We reserve the right to make any alterations that may be required due to technical improvement. For the most current information, contact your **VATECH** representative.

Tel: +82-1588-9510

Email: gcs@vatech.co.kr

Website: www.vatech.com

Headquarters: 13, Samsung 1-ro 2-gil, Hwaseong-si, Gyeonggi-do, 18449, Korea

Factory: 13, Samsung 1-ro 2-gil, Hwaseong-si, Gyeonggi-do, 18449, Korea



The CE symbol grants this product compliance to the European Directive for Medical Devices 93/42/EEC as amended by 2007/47/EC as a class IIb device.



EU Representative; VATECH Global France (SARL)

51 Quai de Dion Bouton 92800 Puteaux France

Tel: +33 1 64 11 43 30 Fax: +33 1 64 11 43 39

Australia Sponsor; VATECH Medical Pty Ltd.

ABN: 78 155 258 923

Address: Suite 5.04 Gateway Business Park 63-79 Parramatta Road,
Silverwater, NSW 2128

Tel: 1300 789 454 (+61 2 9644 4866)

E-mail: info@vatechanz.com.au

Green 16™

ZIP Code : 18449
13, Samsung 1-ro 2-gil, Hwaseong-si, Gyeonggi-do, Republic of Korea
www.vatech.com

vatech