

EzCam™

User Manual



vatech

TABLE OF CONTENTS

1. Introduction	2
2. Safety Information	4
3. Installation	6
4. Operation	7
5. Maintenance	9
6. Specification	10

1. Introduction

1.1 Overview

The EzCam is the latest hand-held Intraoral Camera from Vatech. The advanced ergonomics of the handpiece design are comfortable and easy to use. The camera's integrated capture button makes image acquisition simple.

The EzCam has the following features:

- 5M CMOS image sensor
- 2 LEDs for illumination
- Autofocus
- Capture buttons are on the handpiece
- Direct connection to computer via standard USB cable
- No separate power supply required

1. Introduction



Note

Please read the entire contents of this manual before operating your EzCam Intra oral camera. Please keep this manual in a safe place for future reference.

1.2 System Parts

- Handpiece
- USB 2.0 Cable: 3m (Option: 5m)
- Disposable Sheathes
- Handpiece Holder
- User Manual

1.3 System Requirements

- OS: Windows Vista / Windows 7,8,10
- CPU: Pentium(R) Dual-core 2Ghz or above
- RAM: 1GB
- Communication Port: USB 2.0

2. Safety Information

The EzCam is designed in conformity with ISO, EMC & CE standards. To prevent damage to equipment and minimize the risks to patients, users, and third parties getting injured, please follow the safety notes and operate with care. Liability cannot be accepted for damage resulting from misuse or failure to operate in compliance with the safety notes.

2.1 Safety & Storage Information

- Conformed Safety Standard
 - Safety: IEC 60601-1: 2005 + CORR. 1 (2006) + CORR. 2 (2007) +AM1(2012)or IEC60601-1:2012
 - EMC: EN 60601-1-2 : 2007
- Transportation and Storage Conditions
 - Temperature: 10~ 55 °C (50~131°F)
 - Relative Humidity: 10~ 90%
 - Ambient pressure: 700~ 1060 hPa

2. Safety Information

2.2 Precautions

- Do not expose your camera to liquids or store in a damp place (it is not waterproof).
- Do not drop the handpiece.
- Store the camera in a clean, dry and well ventilated place.
- Avoid physical impacts on the handpiece.
- Place the handpiece in the handpiece holder when not in use.
- Use disposable sheaths to avoid cross contamination and to maintain warranty coverage.
- Operating Condition
 - Temperature: 10~ 40 °C(50~104°F), Relative Humidity: 10~ 80%, Ambient Pressure: 700~ 1060 hPa
- Camera may reach a maximum temperature of 46°C (114.8°F) if operated in an ambient temperature of 40°C(104°F).

2.3 Classification

- Medical Devices Directive (93/42/EEC): Class I
- Type of protection against electric shock: Class II Equipment
- Degree of protection against electric shock: B Type
- Degree of protection against the ingress of water: IPX0
- Equipment not suitable for use in the presence of a flammable anesthetic mixture with air or with oxygen or nitrous oxide.

3. Installation



Warning

- The EzCam is not waterproof. Do not immerse in water or any form of liquid.
- Do not sterilize the handpiece by autoclave.
- Beware of electromagnetic radiation generated from other electrical appliances, as they may cause the EzCam to malfunction.
- Do not operate with devices that do not comply with EN60601-1, EN60601-1-2 medical equipment standards.

3. Installation

3.1 Connect the supplied USB cable to the handpiece.

3.2 Connect the supplied USB cable to a USB 2.0 port on your PC.

- The EzCam does not require proprietary drivers. Once the camera is connected to a PC that meets the system requirements, the camera will function.

4. Operation

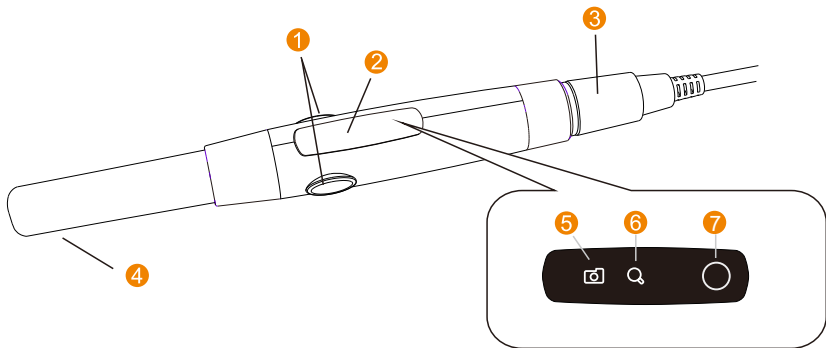

- ① Image capture button/ ② User interface/ ③ USB Plug /④ Camera lens/
⑤ Camera status indicator/ ⑥ Macro indicator/ ⑦ Macro button

4. Operation

4.1 Camera On/Off

- Open your dental imaging software's intraoral camera acquisition feature. The EzCam will automatically turn on and the Camera status indicator 5 will turn green.
- When you close the intraoral camera image acquisition feature in your imaging software, the EzCam will automatically turn off and the Camera status indicator 5 will change to blue.
- The EzCam may be manually turned on/off by pressing and holding the power on/off button on the handpiece. The camera will automatically turn itself off after 10 minutes of inactivity.

4.2 Focusing

- When you turn on the camera - auto-focus mode.
- Press the macro button 7, zoom-in and fix the focus (Macro indicator 6 will be turned on).
- Pressing the macro button 7 again reverts to the auto-focus mode (Turn off macro indicator 6).

4.3 Image capture

- Press the image capture button 1 on the handpiece to store still images in your imaging software.

5. Maintenance

5.1 Handpiece Cleaning

- Please disconnect the camera from the USB port and detach the USB cable from the handpiece before starting any cleaning procedures. Do not immerse the handpiece in fluids. Do not spray any cleaning solutions directly on the handpiece. To clean the handpiece housing, use a soft, clean, and lint-free cloth dampened with non-corrosive disinfectant solution.

5.2 Test

- Monthly test
 - Inspect the USB cable and connector to prevent damage on the camera system.



Warning

- The PC workstation that connects to the EzCam via compatible USB cable is an integral part of a Medical Electrical System. The PC must be a CE-approved computer system conforming with the EN60601-1 or EN60950-1.
- No modification of this equipment is allowed.

6. Specification

- Sensor: CMOS/5MP
- Resolution: 1280X720
- Light Source: 2 White LEDs
- Focus Range: 9mm~35mm
- Angle of View: 62°
- Length of Cable: USB 2.0, 3m (Option: 5m)
- Dimension: 198 x 24 x 23mm (77.95x 9.45x 9 inch)
- Weight: 40g (0.088 lb)
- Rating: 5 VDC, 500mA
- Power Supply: No separate power supply required (through USB 2.0 port)

**Vatech France**

Floor 4, 51 Quai de Dion Bouton
92800 Puteaux, France













**DENTALL Co.,Ltd.**

301-905 Bucheon Technopark, 345 Seokcheon-ro, Ojeong-gu,
Bucheon-si, Gyeonggi-do, 14501 KOREA
Tel: +82-32-327-6026 Fax: +82-32-327-6027

**Disposal**

The device must be disposed of properly. Within the European Union,
the device must be disposed of in accordance with EU Directive 2012/19/EU(WEEE).

SYMBOLS

	Direct current		See instruction for use
	Attention, consult accompanying documents		Manufacturer
	Keep dry		Manufacture date
	Disposed of correctly in accordance with EU Directive 2012/19/EU(WEEE)		CE mark
	Serial NO.		Type B applied part
	Temperature limit		Humidity limitation
	Atmospheric Pressure Limitation		

EzCam™

EzCam-V1.0/20200916

Postal Code: 18449
13, Samsung 1-ro 2-gil, Hwaseong-si, Gyeonggi-do, Korea

vatech