

EzRay Air™ Wall

User Manual

English v 1.41

EzRay Air™ Wall

User Manual

English



vatech

EzRay Air™ Wall

13, Samsung 1-ro 2-gil, Hwaseong-si, Gyeonggi-do, Republic of Korea
ZIP Code : 18449
www.vatech.com

Notice

The **EzRay Air Wall (VEX-S300W)** is an intra-oral dental X-ray system.

This manual contains descriptions, operating instructions, imaging procedures for the **EzRay Air Wall (VEX-S300W)** dental X-ray system. It is recommended that you thoroughly familiarize yourself with this manual to make the most effective use of this equipment. Read and understand all cautions, safety messages, and warnings in this manual.

Always keep this manual with the equipment and review the operating procedures and safety instructions if needed.

The illustrations/photos of the equipment in this manual are only for illustration purposes. The actual equipment may look different.

Due to continuous technological improvements, the manual may not contain the most updated information. For further information not covered in this manual, please contact us at:

Phone: (+82) 1588 9510

E-mail: gcs@vatech.co.kr

This document is originally written in English.

The **EzRay Air Wall (VEX-S300W)** is referred to as **Equipment** or **System** in this manual.

Manual Name: EzRay Air Wall (Model: VEX-S300W) User Manual

Document Number: VDH-UM-071

Version: 1.41

Publication Date: 2024-06

This Page is Left Blank Intentionally

Table of Contents

Notice		v
Table of Contents		vii
1.	General and Regulatory Information	1
	1.1 Manufacturer's Liability.....	1
	1.2 Owner and Operator's Obligations	1
	1.3 Conventions In This Manual	2
	1.4 Marks and Symbols.....	3
	1.5 Standards and Regulations.....	7
2.	Safety Instructions	9
	2.1 General Safety Guidelines	9
	2.2 Warnings and Safety Instructions	10
3.	System Overview	13
	3.1 Indications for Use	13
	3.2 Principles of Operation	13
	3.3 Intended User Profile	13
	3.4 Components.....	14
	3.5 Features.....	15
	3.6 General View of the Equipment	16
4.	Operation	21
	4.1 Turning the Power On / Off	21
	4.2 Switching the Operation Mode	22
	4.3 Sleep Mode	28
	4.4 Positioning the Patient	29
	4.5 Acquiring the Image.....	37
5.	Service Mode	42
	5.1 Overview	42
	5.2 Changing System Parameters	43
	5.3 Service Mode Menu.....	47
6.	Troubleshooting	58

7.	User Maintenance	60
8.	Cleaning and Disinfection	62
	8.1 Cleaning	62
	8.2 Disinfection	63
9.	Disposing of the Unit	64
10.	Product Specifications	66
	10.1 Mechanical Specifications	66
	10.2 Technical Specifications	71
	10.3 Electrical Specifications	74
	10.4 Environmental Specifications	75
Appendix		76
	A.1 Using the Rotating Rectangular Cover	76
	A.2 Tables of Exposure Times (Default)	78
	A.3 X-ray Dose Data	79
	A.4 Electromagnetic Compatibility (EMC) Information	87
	A.5 Abbreviations	90

1. General and Regulatory Information

1.1 Manufacturer's Liability

The manufacturers and retailers of this equipment assume responsibility for the safe and normal operation of this product only when:



- Genuine VATECH approved equipment and components have always been used.
- A VATECH authorized agent has performed all maintenance and repairs.
- The equipment has been used normally following the user's manual.
- The equipment damage or malfunction is not the result of an error on the part of the owner or operator.

1.2 Owner and Operator's Obligations

- The owner of this equipment shall perform maintenance at regular intervals to ensure patient and operator safety. These tests must be performed following local X-ray safety regulations.
- The owner of this equipment shall perform regular inspection and maintenance of the mechanical and electrical components of this equipment to ensure safe and consistent operation (IEC 60601-1).
- The owner of this equipment shall ensure inspection and cleaning work is performed following the maintenance schedule outlined in **7. User Maintenance**.











1.3 Conventions In This Manual

This manual uses the following conventions to inform users. Please familiarize yourself with each convention and follow the accompanying instructions.









 WARNING	WARNING	Failure to comply with the given information may result in severe injuries to the people or damage to the equipment.
 CAUTION	CAUTION	Requires the user's immediate attention or action due to the possibility of safety issues.
IMPORTANT	IMPORTANT	Requires the user's attention because the stated action and environment may cause trouble.
NOTICE	NOTICE	Indicates useful information for users.
	RADIATION	Indicates a possible danger from radiation exposure.

1.4 Marks and Symbols

The following table describes the purpose and location of safety symbols and other valuable information provided on the equipment.

Mark/Symbol	Description	Location
	Alternate current	Main Label
	Attention: consult accompanying documents	Main Label
	Dangerous voltage	Powerboard, X-ray Generator, Generator Label
	Protective earth (Ground)	Power Box Base
	Off (power: disconnected to the Main Power Switch)	Main Power Switch
	On (power: connected to the Main Power Switch)	Main Power Switch
	IEC60601-1 The degree of Protection from Electric Shock TYPE B Equipment	Main Label
	Radiation hazard	Main Label, Generator Label
	Authorized European Representative name and address	Main Label
	The CE symbol indicates that this product complies with the European Directive for Medical Devices 93/42/EEC as amended by 2007/47/EC as a class IIb device.	Main Label
	UL mark No. E476672	Main Label

1. General and Regulatory Information

Mark/Symbol	Description	Location
	Prescription Requirement label Caution: Federal law restricts this device to sale by or on the order of a licensed healthcare practitioner.	Main Label
	Manufacturer's name and address	Main Label, Generator Label
	Date of manufacture	Generator Label, Manufacture Label
	Serial Number	Generator Label, Manufacture Label
	This symbol indicates that electrical and electronic equipment must not be disposed of as unsorted municipal waste and must be collected separately.	Main Label
	ESD susceptibility symbols indicate that an item is susceptible to damage from electrostatic discharges.	Board package
	Refer to the User Manual.	Main Label
	This symbol indicates the direction of cover attachment/detachment.	Cone upper part

1.4.1 Label Locations

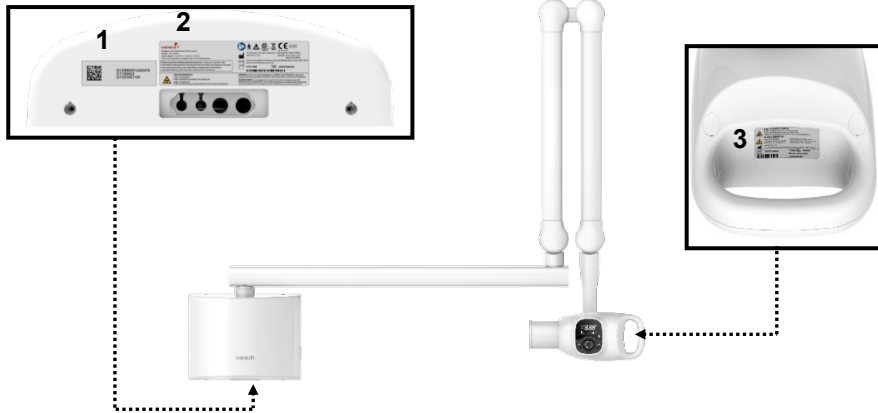

1. UDI Label

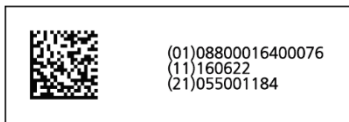

2. Main Label

Product: Dental X-ray System Model: VEX-S300W Power Input: 100-240 V~, 50/60 Hz, 4-2 A This X-ray equipment complies with 21 CFR Subchapter J.		13, Samsung 1-ro 2-gil, Hwaseong-si, Gyeonggi-do, 18449, KOREA VATECH Co., Ltd. Website: www.vatech.com		51 Quai de Dion Bouton 92800 Puteaux France, Vatech Global France (SARL)		MADE IN KOREA	
Mode of operation (Mode de fonctionnement): Continuous operation with intermittent loading—This equipment needs a rest time of at least 60 times the exposure time before starting the next exposure. (Fonctionnement en continu avec chargement intermittent — Cet équipement nécessite une période de repos d'au moins 60 fois le temps d'exposition avant de commencer l'exposition suivante.)		CAUTION (PRUDENCE) X-RAY / ATTENTION: X-RAY ON WHEN EQUIPMENT IN OPERATION X-RAY / ATTENTION: X-RAY ACTIVE LORSQUE L'ÉQUIPEMENT EST EN FONCTIONNEMENT		WARNING: X-ray unit may be dangerous to PATIENT and OPERATOR unless safe exposure factors, operating instructions and maintenance schedules are observed. AVERTISSEMENT: Cet équipement à rayons X peut être dangereux pour les PATIENTS et les OPÉRATEURS si les facteurs d'exposition sécuritaires, les instructions de fonctionnement et les programmes de maintenance ne sont pas respectés.			

3. Generator and manufacture Label

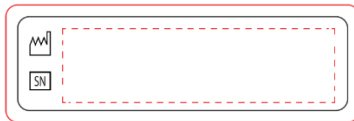
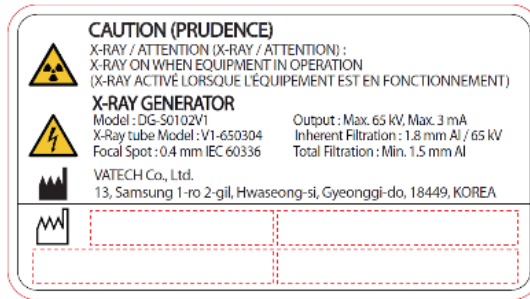

NOTICE

The labels in this manual are only for illustration purposes. Actual labels may look different.

NOTICE

The Canadian warning label (See below) is attached only to products sold in Canada.





1.5 Standards and Regulations

Standards

The **EzRay Air Wall (VEX-S300W)** is designed and manufactured to meet the following

- MEDICAL - APPLIED ELECTROMAGNETIC RADIATION EQUIPMENT AS TO ELECTRICAL SHOCK, FIRE AND MECHANICAL HAZARDS ONLY IN ACCORDANCE WITH
ANSI/AAMI ES60601-1 (2005) + AMD 1 (2012),
CAN/CSA-C22.2 No. 60601-1 (2014), IEC 60601-1-3:2008 + AMD1:2013, IEC 60601-2-65:2012 + AMD1:2017
- 21 CFR 1020.30 & 1020.31
- ISO 13485

	<p>This is Class IIb equipment and obtained CE marking in April 2007 for regulations compliance by the revised European Union's MDD (Medical Devices Directive) 93/42 EEC.</p>
	<p>This equipment received the UL certification mark in accordance with ANSI/AAMI, CAN/CSA-C22.2 No. 60601-1 regulations.</p>

Classifications (IEC60601-1 6.1)

Protection against the ingress of water: Ordinary Equipment (IPX0). Protection against electric shock: Class I equipment, Type B Applied Parts: Conehead







This Page is Left Blank Intentionally

2. Safety Instructions

2.1 General Safety Guidelines

- This equipment is designed and manufactured to ensure the greatest safety of operation. Operate and maintain it in strict compliance with the safety precautions and operating instructions contained in this manual.
- Legally qualified people must only operate this equipment.
- Observe all local fire regulations. Always keep a fire extinguisher near the equipment.
- The equipment must be installed, maintained, and serviced by qualified service personnel according to the procedures and preventive maintenance schedules.
- Ensure that the on/off switch is set to off when the equipment is not in use.
- Always disconnect the power supply before cleaning the equipment.
- DO NOT keep the equipment or its parts in a humid place or near a liquid substance.
- Avoid placing the equipment near chemical storage and gas-filled storage facilities.

2.2 Warnings and Safety Instructions

 WARNING	<p>This X-ray unit may be dangerous to patient and operator unless safe exposure factors, operating instructions, and maintenance schedules are observed.</p>
 WARNING	<p>It is essential to read this user manual carefully and strictly abide by all warnings and cautions stated within it.</p>
 WARNING	<p>To avoid the risk of electric shock, this equipment must only be connected to supply mains with protective earth.</p>
 WARNING	<p>Since rules and regulations concerning radiation safety differ between countries, it is the responsibility of the owner and operator of this equipment to comply with all applicable rules and regulations concerning radiation safety and protection in their area.</p>

- Never expose this equipment to liquids, mist, or sprays. Exposing this equipment to liquids may cause an electrical shock or otherwise damage the system.
- Never use this equipment in an environment that is susceptible to explosion.
- Never touch the patient while also touching the SIP/SOP connectors.
- Never try to modify this equipment, including the wires or cables. Modifying this equipment may damage it beyond repair.
- DO NOT open or remove the cover panels on this equipment.
- DO NOT use spray cleaners on this equipment, as this could cause a fire.
- DO NOT place flammable materials near this equipment.
- The medical electrical equipment is subject to special EMC preventive measures. For more details, refer to **A.4 Electromagnetic Compatibility (EMC) Information**.
- We recommend that the patient and the operator wear protective lead-lined aprons unless other Radiation Protection Protocols apply locally.
- Children and pregnant women must consult with a doctor before X-ray exposure.
- Serious dangers may occur from electromagnetic interference (i.e., Noise) between other equipment in the area during specific examinations or medical treatment.

Radiation Safety



When using the equipment, it is recommended that all users comply with the following radiation safety guidelines for the safety of the users and the patients.

- This equipment should be operated by a trained and qualified dentist or a dental technician in a controlled environment.
- All users and patients should wear protective equipment, such as a lead apron, thyroid collar, etc.
- Pregnant women should not be exposed to X-rays unless it is strictly necessary.
- All users should comply with the Radiation Protection Policies established by the government.
- Any person or organization that installs an external Door Interlock Switch is responsible for ensuring that the Switch has a radiation indicator or an equivalent alarm system to show the state of the current.
- This equipment should be operated at least 2 m away from the operator when operated in or outside of the room. For details on the Scattered Dose data, please refer to Scattered Dose section of **A.3 X-ray Dose Data**.

This Page is Left Blank Intentionally

3. System Overview

The **EzRay Air Wall (VEX-S300W)** is an intra-oral dental X-ray system intended for intra-oral imaging. It consists of an X-ray generator, an X-ray controller, a beam limiting device, an operation panel, and a mechanical arm. The X-ray controller allows for accurate exposure control, and the adjustable mechanical arm allows for easy positioning. The system can be used with an imaging system.

3.1 Indications for Use

The **EzRay Air Wall (VEX-S300W)** is an intra-oral dental X-ray system (extra-oral X-ray source system) intended for use by a trained and qualified dentist or dental technician for both adult and pediatric subjects for producing diagnostic dental radiographs for treatment of diseases of the teeth, jaw, and other oral structures using intra-oral image receptors.

3.2 Principles of Operation

X-rays are emitted when a high voltage is supplied to the X-ray tube assembly, which frees electrons from the cathode. They hit the anode to produce X-rays. The equipment acquires images by emitting X-rays continuously on the human tooth.

3.3 Intended User Profile

Considerations	Requirement Description
Education	A licensed dentist or dental hygiene, radiologist and graduates of relevant bachelor's degree (national qualifications)
Knowledge	The operator must have understood: <ul style="list-style-type: none"> ▪ Treatment and diagnosis of dental disease ▪ Terms and guidance of diagnostic medical radiation devices ▪ Device connection, installation, and operating conditions.
Language understanding	The operator must have understood: <ul style="list-style-type: none"> ▪ The English or Korean manuals (or other languages provided).
Experience	The operator must have understood: <ul style="list-style-type: none"> ▪ Objectives and effects of treatment and diagnosis of dental disease using diagnostic medical radiation devices ▪ Normal operation of diagnostic medical radiation devices ▪ The contents of the user manual.

3.4 Components

No.	Item	Standard	Option	Qty.
1	PowerBox Assembly	•		1
2	Scissor Arm Assembly	•		1
3	X-ray Generator Assembly	•		1
4	User Manual	•		1
5	Installation Manual	•		1
6	Round Cover	•		1
7	Remote Exposure Switch*	•	•	1
8	Remote Exposure Switch (Doorbell type)	• (USA Only)	•	1
9	Remote Exposure Switch Cable (Doorbell type)	• (USA Only)	•	1
10	Door Interlock Cable	•	•	1
11	AC Power Cable		•	1
12	Rectangular Cover (2x3)		•	1
13	Rectangular Cover (4x3)	•	•	1
14	Double Stud		• (USA Only)	1
15	Horizontal Arm Assembly 450 mm		•	1
16	Horizontal Arm Assembly 600 mm		•	1
17	Horizontal Arm Assembly 900 mm		•	1
18	Scissor Arm Cover		•	1
19	Rotating Rectangular Cover (2x3)		•	1
20	Rotating Rectangular Cover (4x3)		•	1

* The standard **Remote Exposure Switch** can additionally be provided as an optional item if needed. For details on the Remote Exposure Switch and Power Cable Connections, refer to **4.5.1 Remote Exposure Switch and Power Cable Connections**.

3.5 Features

The **EzRay Air Wall (VEX-S300W)** is an intra-oral dental X-ray system that offers safety, reliability, and greater functionality:

- Ergonomic design and shape for the safety and comfort of patients
- Easy-to-use Control Panel that provides a straightforward process
- Full swivel revolve in all directions
- Tube head revolves freely around the sphere
- Compact, lightweight components

3.6 General View of the Equipment

Main Body

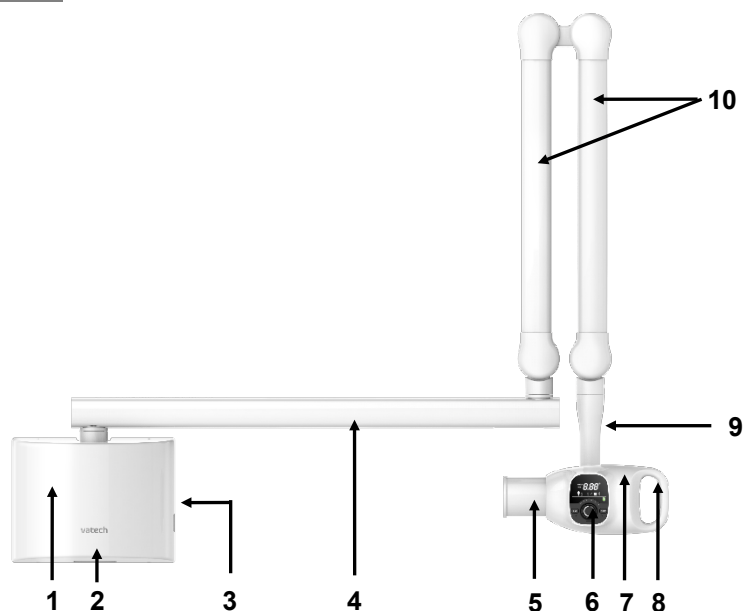













No.	Item	Description
1	Power Box Assembly	Controls the electrical power of the system.
2	Remote Exposure Switch and Power Cable Connectors	Connect the X-ray Exposure Switch cable and AC power cable (manufacturing option). Refer to 4.5.1 Remote Exposure Switch and Power Cable Connections for detail information.
3	Main Power Switch	Main Power On/Off switch
4	Horizontal Arm	Connection arm between the power box assembly and the scissor arm assembly. (3 length options: 450 mm, 600 mm, 900 mm)
5	X-ray Beam Limiting Device	Limits the X-ray exposure area. Default type: Round Cone + Round Cover (FOV: Ø 6 cm)
6	Control Panel	Display for the X-ray exposure settings and operation conditions
7	X-ray Generator	Includes the X-ray tube and the high-voltage generator.
8	Handle	Grip the handle securely when using the system.
9	X-ray Generator Arm	Connection arm between the X-ray generator and the scissor arm assembly
10	Scissor Arm Assembly	Adjusts the length of the entire arm by folding and unfolding the scissor arm assembly. Connection arm assembly between the horizontal arm and the X-ray generator assembly.

Control Panel

No.	Item	Description
1	Tube Voltage/Current Indicator	Indicates the tube voltage and tube current of the system.
2	Angle/Time Display	Displays the X-ray exposure time, error code, cooling time, and exposure angle.
3	Adult/Child Selection	Indicates a patient type (adult or child).
4	Tooth Type Selection	Indicates a tooth type (incisor, canine, molar/premolar, bitewing).
5	X-ray Exposure Indicator	Indicates the X-ray exposure status. (Green: Ready / Yellow: X-ray ON)
6	SET Button (with LED lamp)	Resets the X-ray exposure angle. (SET button is pressed. → The LED lamp flickers one time.)
7	Jog Dial	Turn the jog dial left (-) or right (+) to select X-ray exposure settings, press the jog dial to confirm the operating settings.
8	AUTO Button (with LED lamp)	Selects a tooth and exposure time automatically based on the X-ray exposure angle. (1. If the AUTO button is pressed, the LED lamp flickers one time. 2. If the AUTO Mode is ON, the LED lamp is ON.)
9	Speaker	Sound alarm for X-ray exposures

Available Option Items

No.	Illustration/Photo	Option name	Usage	Material
1		Rectangular Cover 2x3 (FOV: 2x3 / 3x2 cm)	Used for limiting the X-ray exposure area by covering the X-ray Beam Limiting Device except for the 2x3 (3x2) rectangular area	ABS (Acrylonitrile butadiene styrene) copolymer
2		Rotating Rectangular Cover 4x3 (3x4) FOV: 4x3cm, 3x4cm (This adaptor can be used as both 4x3 and 3x4.)	Performs the same function as the Rectangular Cover. Moreover, Rectangular Cover rotates in 360 degrees and adjustable in 90-degree and 10-degree increments.	ABS (Acrylonitrile butadiene styrene) copolymer
3		Rotating Rectangular Cover 2x3 (3x2) FOV: 2x3cm, 3x2cm (This adaptor can be used as both 2x3 and 3x2.)	Performs the same function as the Rectangular Cover. Moreover, Rectangular Cover rotates in 360 degrees and adjustable in 90-degree and 10-degree increments.	ABS (Acrylonitrile butadiene styrene) copolymer
4	 ESW-K1 & ESW-K2	Exposure Switch, Exposure Switch Holder (if the Control Panel is installed to the wall framework)	Used to remotely perform exposure by pressing the Remote Exposure Switch	ABS (Acrylonitrile butadiene styrene) copolymer
5		Remote Exposure Switch (Doorbell type)	Used with the standard 'Remote Exposure Switch' (only if needed)	Steel (painted)
6		Remote Exposure Switch Cable (Doorbell type)	Used to connect the Remote Exposure Switch to the Remote Exposure Switch Connector on the bottom of the PowerBox Assembly	PVC

7		Door Interlock Cable	Used to connect the Door Interlock Switch to the Door Interlock Cable Connector on the bottom of the PowerBox Assembly	PVC
8		Scissor Arm Cover	Used to cover the Scissor Arm	PVC
9		AC Power Cable	Used to connect the power (AC 220 V) to the Power Box Assembly	PVC
10		Double Stud	Used for fixing the power box to the wall (when installing the power box on the wooden wall in the North America regions)	ABS (Acrylonitrile butadiene styrene) copolymer + SPCC
11		Horizontal Arm 450 mm	Used as a connection arm (length: 450 mm) between the Power Box Assembly and the Scissor Arm Assembly	AL6061 + ABS (Acrylonitrile butadiene styrene)
12		Horizontal Arm 600 mm	Used as a connection arm (length: 600 mm) between the Power Box Assembly and the Scissor Arm Assembly	AL6061 + ABS (Acrylonitrile butadiene styrene)
13		Horizontal Arm 900 mm	Used as a connection arm (length: 900 mm) between the Power Box Assembly and the Scissor Arm Assembly	AL6061 + ABS (Acrylonitrile butadiene styrene)

This Page is Left Blank Intentionally

4. Operation

4.1 Turning the Power On / Off

1. Turn on the system referring to the following figure and table.

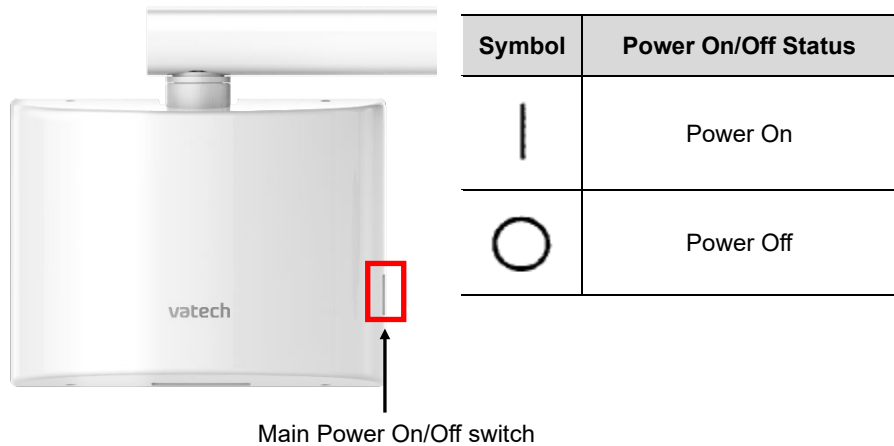

2. The following displays light up. For further information, see 'Control Panel' on page 15.



4.2 Switching the Operation Mode

This system can be operated with Manual Mode and Auto Mode, and you can set up the mode by using the **AUTO** button.

Manual Mode

1. To start the Manual Mode, check if the lamp under the **AUTO** button is turned off.



2. When the tooth type selection area flickers, turn the jog dial to select the tooth type. To see the Control Panel before and after selection, refer to the figures below.



Before tooth type selection





After tooth type selection



Tooth Type

Symbol	Type
	Incisor
	Canine



	Molar/Premolar
	Bitewing

- After tooth type selection, the patient type should be selected. When the Adult/Child selection area flickers, turn the jog dial to select the patient type. To see the Control Panel after selection, refer to the figure below.

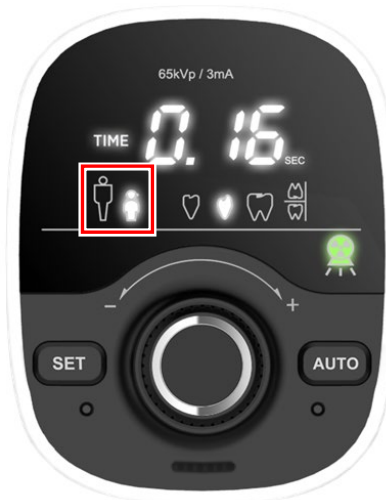
After patient type selection



Patient Type

Symbol	Type
	Adult
	Child

NOTICE

After the tooth type and patient type are selected, the exposure time is automatically displayed.

- If you want to change the exposure time, turn the jog dial to adjust the exposure time from 0.05 to 0.5 s. (increments: 0.01 s)

NOTICE

If you press the jog dial after adjusting the exposure time in Manual Mode, the exposure time is returned to the default setting.

To save the exposure time as default in Manual Mode, press and hold the jog dial for about 3 seconds.

Auto Mode

1. When the Auto Mode is turned on by pressing **AUTO**, the default angle is displayed, as shown in the following figure.



NOTICE

To set the starting point during exposure, press **SET**.

2. Position the system to the teeth to perform exposure. To see how to perform the patient positioning, refer to **4.4 Positioning**. (The following figure is an example of the maxilla incisor.)



3. When tooth types are selected, the exposure angles are automatically set according to the tooth type. To check the default exposure angles, refer to the following table.

Tooth Type	Angle of Inclination
Incisor	Maxilla: +40° ~ +50°
	Mandible: -22° ~ -28°
Canine	Maxilla: +40° ~ +50°
	Mandible: -17° ~ -23°
Molar/Premolar	Maxilla: +25° ~ +35°
	Mandible: -2° ~ -8°
Bitewing	+3° ~ +12°

NOTICE

Since the angles of inclination for the maxilla incisor and canine are the same, the exposure time of the canine is applied to both the maxilla incisor and canine.

Refer to the following figure to see the angle for molar/premolar.



4.3 Sleep Mode

When the device remains inactive for 5 minutes, the system enters 'sleep mode', and all displays, except for the LEDs under the SET and AUTO buttons, are turned off as illustrated below.



During the sleep mode, the LEDs under the SET and AUTO buttons will blink at every one second.

NOTICE



To leave the sleep mode, take one of the following actions:

- Press the SET button or AUTO button.
- Press or turn the jog dial.
- Move header up or down.
- Press the X-ray exposure button on the device.

WARNING

Pressing the X-ray exposure button activates X-ray emission. When exiting sleep mode by pressing the button, ensure that the X-ray emitter (head) is not directed toward a person.

4.4 Positioning the Patient

Positioning the Patient

To obtain high-quality intra-oral radiography with maximum details, take extra care in all steps of the radiography process: positioning the patient and the X-ray imaging system, exposing the intra-oral sensor.

1. Place a protective lead apron on the patient's chest.
2. Have the patient sit on the chair with the sagittal plane vertical.
 - For radiography of the upper maxillary, the Frankfort Plane must be horizontal.

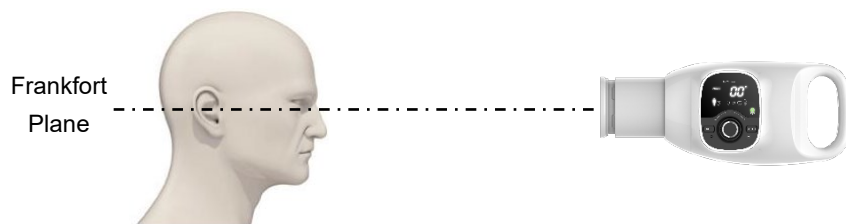

- For radiography of the lower maxillary, the Occlusal Plane must be horizontal.

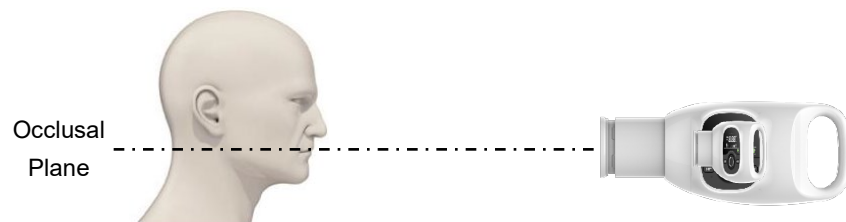

3. Place the tube head cone in the area you want to take an image.

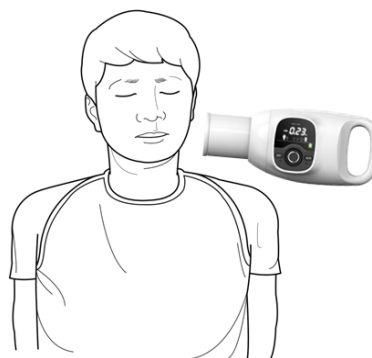

For further information about the patient positioning and beam angle for each mode, refer to the following **Positioning Instructions**.

Positioning Instructions

Paralleling technique: The sensor is placed in a holder that is used to align the sensor parallel to the long axis of the teeth.

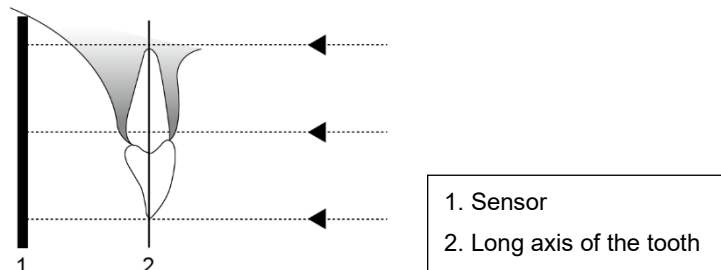

Bisected angle technique: The patient holds the sensor in place with his/her finger. The X-ray beam is directed perpendicularly towards an imaginary line, which bisects the angle between the sensor plane and the long axis of the tooth.

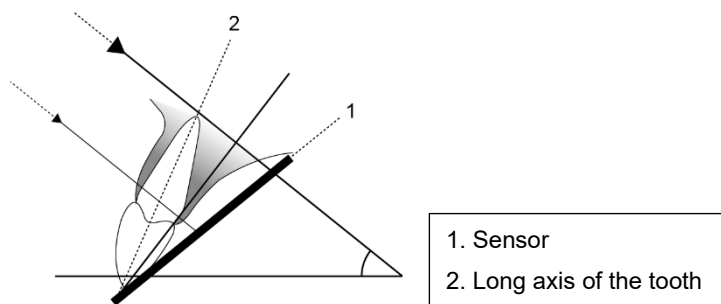

Position the tube head to the patient using the accepted standard positioning procedures.

Here are the specific angulations and directions for the tube head to take the best images of a particular tooth (i.e., **Bisected angle technique**).



Position the receptor carefully not to damage the soft tissue of the patient's intra-oral area.

- **Maxillary Incisor**

The x-ray beam is directed downward at 45°.

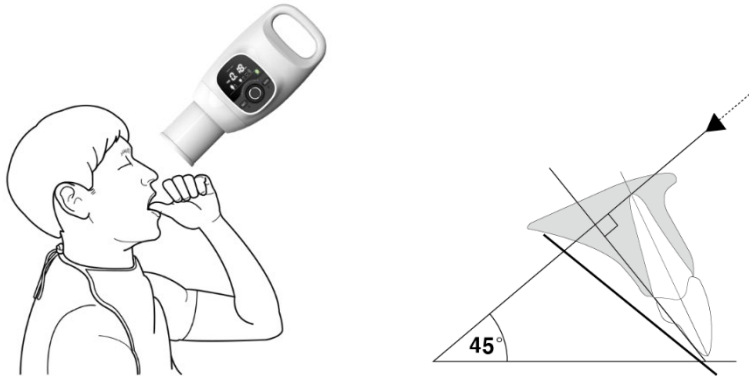

Teeth		Angle of inclination
Incisor	Maxilla	+45°

- **Mandibular Incisor**

The x-ray beam is directed upward at 25°.

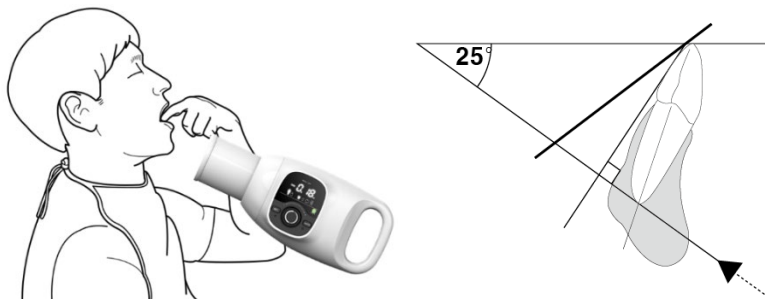

Teeth		Angle of inclination
Incisor	Mandible	-25°

- **Maxillary Canine**

The x-ray beam is directed downward at 45°.

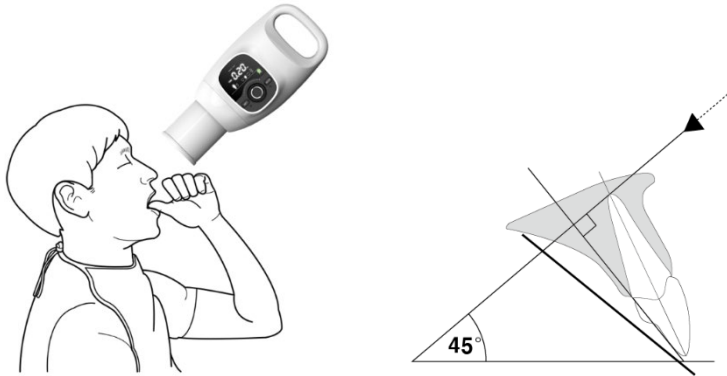

Teeth		Angle of inclination
Canine	Maxilla	+45°

- **Mandibular Canine**

The x-ray beam is directed upward at 20°.

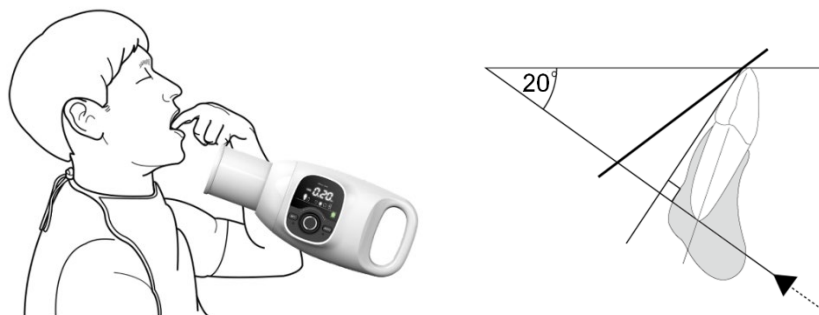

Teeth		Angle of inclination
Canine	Mandible	-20°

- **Maxillary Molar and Premolar**

The x-ray beam is directed downward at 30°.

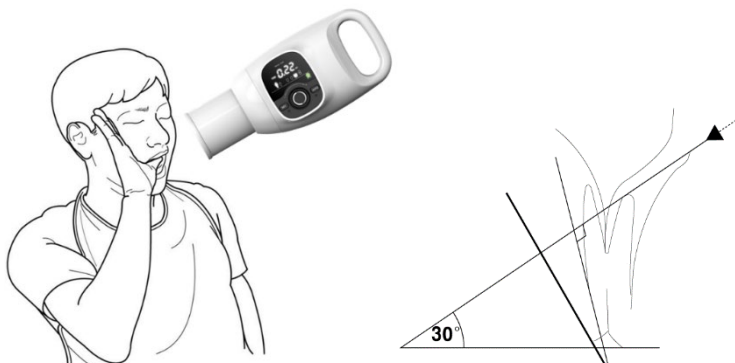

Teeth		Angle of inclination
Molar and Premolar	Maxilla	+30°

- **Mandibular Molar and Premolar**

The x-ray beam is directed upward at 5°.

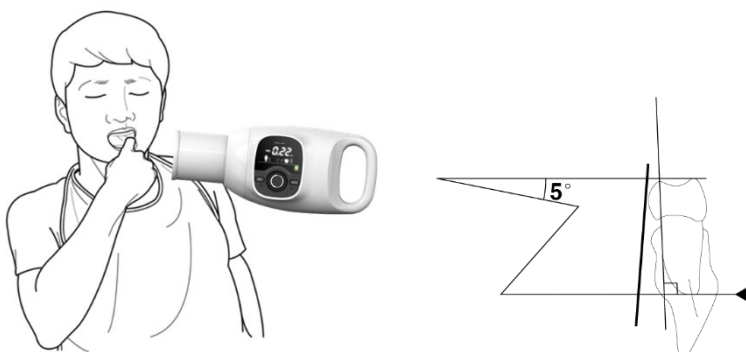

Teeth		Angle of inclination
Molar and Premolar	Mandible	-5°

- **Bitewing**

For a bitewing exposure, the patient closes their teeth during exposure on the sensor holder.

The x-ray beam is directed downward at $5^{\circ} \sim 8^{\circ}$.

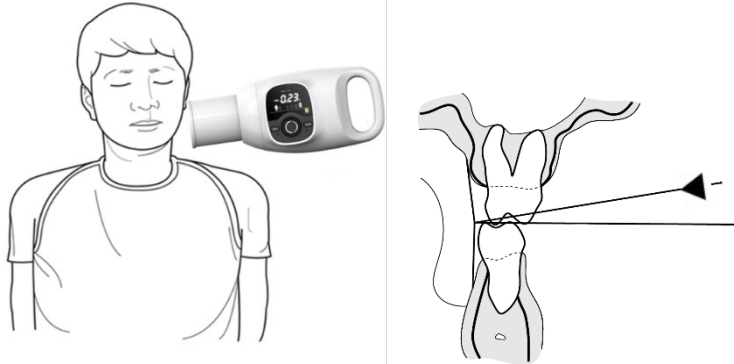

Teeth	Angle of inclination
Bitewing exposure	$+5^{\circ} \sim +8^{\circ}$

Positioning the Imaging Sensor

To ensure image quality, the digital imaging sensor must be appropriately positioned (for information about the proper placement of the imaging sensor, please refer to 'Positioning Instructions' on *page 26*).

- Failure to position the imaging sensor properly can result in errors on the radiograph, such as distorted teeth and roots, elongation, magnification, and overlapping contacts.

NOTICE

The paralleling technique generally reduces the risk of such errors, but if you position the sensor improperly, angulation errors may occur (angulation of the sensor to the tooth itself).

- Failure to align the imaging sensor with the exit pattern of the X-ray beam can result in cone-cuts on the radiograph. The cone-cuts are bright areas that are shown on the radiograph when part of the radiograph is not exposed to radiation. Please refer to the following figure as an example of cone-cuts.

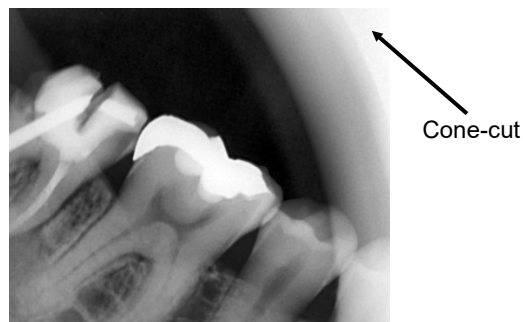

The following figure indicates how the cone-cut occurred by showing the position of the imaging sensor and the radiation area.

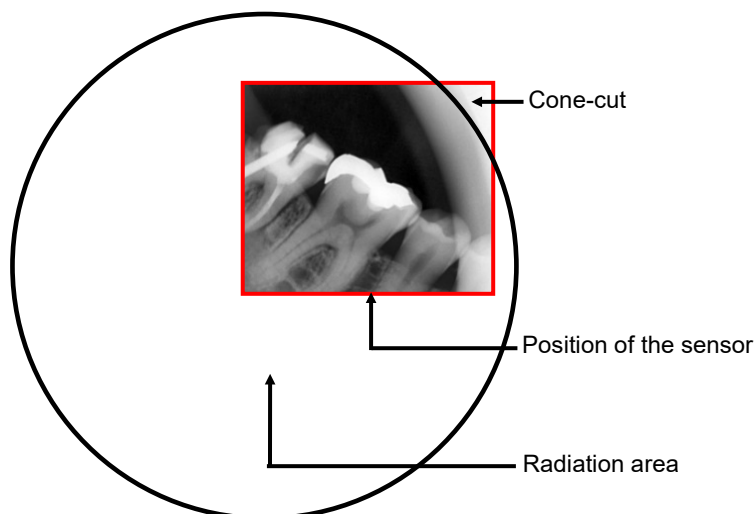

4. Operation

To ensure proper alignment between the imaging sensor and the X-ray beam, it is recommended to use a PID (Position Indicating Device).

When using the PID, the exit pattern of the X-ray device should be aligned perpendicular to the target receptor.

NOTICE

Once the PID is properly aligned, instruct the patient not to move.

4.5 Acquiring the Image

IMPORTANT

The operator should guide the patient to maintain their position during the exposure process.

To acquire the image,

1. Press the exposure switch.

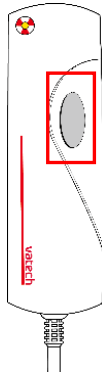



(ESW-K1)



(ESW-K2)

2. During the X-ray exposure,
 - The X-ray indicator lights up with an audible sound.
 - Keep pressing the exposure button until the X-ray indicator goes off and the sound stops.

Location of the X-ray Exposure Indicator	Indicator Status	
	Green: Ready	Yellow: X-ray ON
Control Panel		

IMPORTANT

Hold the Exposure Button or switch until the audible sound stops. Otherwise, the exposure fails and an error message appears on the Control panel.

IMPORTANT

Keep vocal/visual contact with the patient during exposure. In an emergency, release the exposure switch immediately.

IMPORTANT

If the Door Interlock Switch (option) has been installed, X-ray exposure will be stopped once the door of the X-ray room is opened.

If DAP Display Mode is On

The DAP value for each exposure appears on display panel for a preset period of time.

- If DAP value is lower than 10, the panel displays the rounded value down to 1 decimal place.
(e.g. 4.11 → 4.1)
- If DAP value is 10 or higher, the panel displays the rounded value of integer only.
(e.g. 16.94 → 17)



NOTICE

All functions except jog dial are locked until the DAP display time is over. Operator may skip the DAP display by pressing the jog dial once.

NOTICE

User can configure the settings of DAP Display Mode through the Service Mode.

- To activate / deactivate the DAP display mode, refer to **5.3.9 DAP Display Mode On/Off**.
- To set the display time of the DAP value, refer to **5.3.10 DAP Display Time Setting**.

4.5.1 Cooling Time

If the exposure button is pressed again before cooling time is over, the display panel shows the remaining cooling time before the next exposure.

(e.g. **C.06** = remaining cooling time : 6 seconds)



The cooling time per exposure is fixed as below.

$$\text{Cooling Time} = \text{Exposure time} \times 60$$







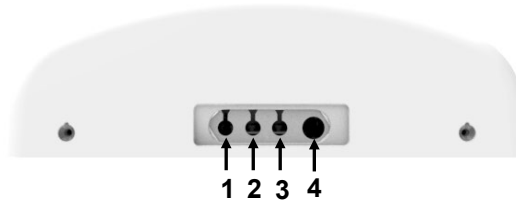

4.5.2 Remote Exposure Switch and Power Cable Connections

There are four connectors on the bottom of the PowerBox Assembly, as described below.

- **Connector 1, 2, 3:** Remote Exposure Switch Connectors
- **Connector 4:** AC Power Cable Connector

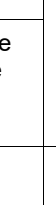

The standard and optional **Remote Exposure Switches**, and the **Door Interlock Cable** are connected to the **Connector 1, 2, and 3**. Please check all seven possible options in the table below.

Option No.	Description	Connector 1	Connector 2	Connector 3	Connector 4
Option 1	Press (1).	 or  (1) Remote Exposure Switch (Standard)	N/A	N/A	AC Power Cable (Option)
Option 2	Press (1) and (2) at the same time.	 or  (1) Remote Exposure Switch (Standard)	N/A	 or  (2) Remote Exposure Switch (Option)	AC Power Cable (Option)
Option 3	Press (1) and (2) at the same time.	 or  (1) Remote Exposure Switch (Standard)	N/A	 (2) Remote Exposure Switch (Doorbell type) (Option)	AC Power Cable (Option)

Option No.	Description	Connector 1	Connector 2	Connector 3	Connector 4
Option 4	Press (1).	or	N/A		AC Power Cable (Option)
		(1) Remote Exposure Switch (Standard)		(2) Door Interlock Cable (Option)	
Option 5	Press (1) or (2).	or		N/A	AC Power Cable (Option)
		(1) Remote Exposure Switch (Standard)	(2) Remote Exposure Switch (Option)		
Option 6	Press (1) or (2).	or		N/A	AC Power Cable (Option)
		(1) Remote Exposure Switch (Standard)	(2) Remote Exposure Switch (Doorbell type) (Option)		
Option 7	Press (2) and (3) at the same time. (1): Not used in this option.	or			AC Power Cable (Option)
		(1) Remote Exposure Switch (Standard)	(3) Remote Exposure Switch (Doorbell type) (Option)	(2) Remote Exposure Switch (Doorbell type) (Option)	

This Page is Left Blank Intentionally

5. Service Mode

5.1 Overview

In the Service Mode, users can check and change the following settings:

- 5.3.1 Factory Default Settings
- 5.3.2 Exposure Time Settings (for each patient and tooth type)
- 5.3.3 User Default Settings (for each patient and tooth type)
- 5.3.4 Password Mode On/Off
- 5.3.5 Angle Increments Setting
- 5.3.6 Waiting Time Setting for the Sleep Mode
- 5.3.7 Password Setting
- 5.3.8 Cone Type Setting
- 5.3.9 DAP Display Mode On/Off
- 5.3.10 DAP Display Time Setting

5.2 Changing System Parameters

To change system parameters:

1. Press and hold the **SET button** and **jog dial** simultaneously (for about 3 seconds).



2. Enter the 3 digits of password using the jog dial. (default password: 000)



NOTICE

To customize the password, refer to **5.3.7 Password Setting**.

5. Service Mode

3. Turn the dial to choose a number and press it to move to the next digit.



4. When all three digits are set, press the **jog dial** again to save the setting.
5. After entering the password is completed, the service mode starts as the figure below.



6. The system provides **24** service modes. To change the setting of each mode from **n.01** to **n.24**, press the **AUTO button** on the right. Upon pressing the button, n.01 is displayed on the control panel.

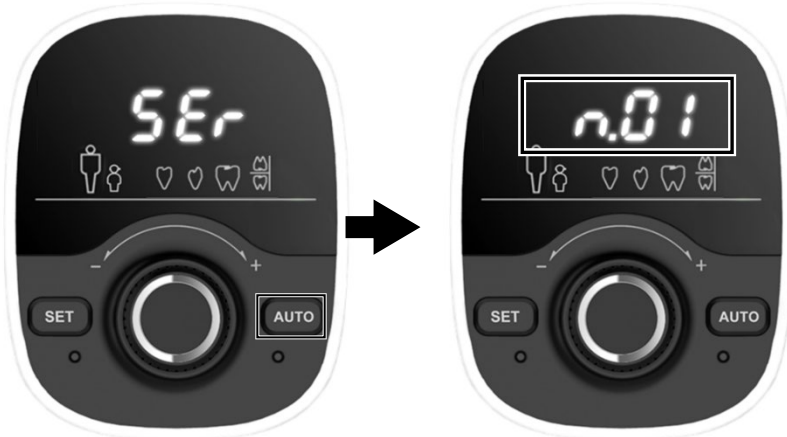

7. To move to the next mode, press the **AUTO button** again. Each time you press the button, the service mode number goes up by one. To return to the previous mode, press the **SET button** on the left. (See **5.3 Service Mode Menu** to learn more information on each mode)
8. Each time you finish changing the system parameter, press the **jog dial** and hold it until you hear a beep.



5. Service Mode

- To quit service mode and resume the operation, press the **SET button** and the **jog dial** simultaneously and hold them for about 3 seconds.



- Restart the device to check if the change is saved correctly.

5.3 Service Mode Menu

See 5.2 Changing System Parameters for entering each service mode.

5.3.1 Factory Default Setting

Factory default setting restore all system mode parameters to their default values except for **n.20 password setting**.

Service Mode No.	Item
n.01	Factory default settings

To restore the system to the factory default settings,

1. Select **n.01** and press the jog dial. When the message “**YES**” is displayed on the control panel, the system is restored to its initial settings.



2. To save the setting, press the jog dial and hold it until you hear a beep.
3. Restart the device to check if the factory default setting is on.

5.3.2 Exposure Time Setting (for each patient and tooth type)

Select a service mode from **n.02** to **n.09** to set up an exposure time for each patient and tooth type. See the table below for more information.

Service Mode No.	Item
n.02	Adult Incisor
n.03	Adult Canine
n.04	Adult Molar/ Premolar
n.05	Adult Bitewing
n.06	Child Incisor
n.07	Child Canine
n.08	Child Molar/ Premolar
n.09	Child Bitewing

To set the exposure time for a specific patient and tooth type as described above,

1. Select the service mode number according to the patient and tooth type (i.e., **n.06** for Child Incisor)



2. After entering the mode, turn the jog dial to adjust the exposure time.
3. Press the jog dial again and hold it until you hear a beep.
4. Restart the device to apply the new changes.

5.3.3 User Default Settings (for each patient and tooth type)

User default settings are activated as the device starts. See the table to change each service mode number aligned with the patient or tooth type.

Service Mode No.	Item
n.10	Adult
n.11	Child
n.12	Incisor
n.13	Canine
n.14	Molar/Premolar
n.15	Bitewing

1. To set the default setting for a specific patient type or a tooth type,
2. Select a service mode number between **n.10** (Adult) and **n.11** (Child) for a specific patient type and from **n.12** to **n.15** for a tooth type. For instance, when selecting **n.10** by pressing the jog dial to set the patient type 'adult' as default, then "YES" is displayed on the Control panel.



3. Press the jog dial again and hold it until you hear a beep.
4. Restart the device to apply the new changes.

5.3.4 Password Mode On/Off

Follow the procedure below to turn on and off the password mode.

Service Mode No.	Item
n.16	Password On
n.17	Password Off

To activate the password mode,

1. Select **n.16** and press the jog dial. The message “**YES**” is displayed on the Control panel.

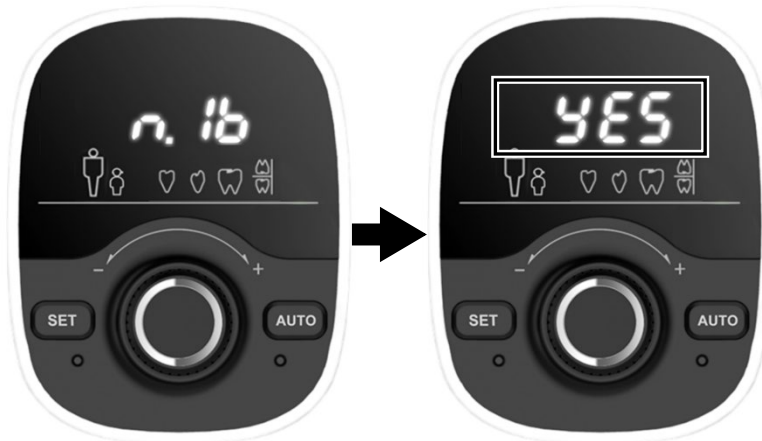

2. Press the dial again and hold it until you hear a beep.
3. Restart the device to apply the new changes.
4. To deactivate the password mode, select **n.17**, and repeat the procedure.

IMPORTANT

In the United States, Password Mode is set as a default and cannot be turned off by users.

5.3.5 Angle Increments Setting

IMPORTANT

Available only in countries that allow the auto mode for use. The mode is not available in the United Kingdom, the United States, and some countries (Consult the sales representative in your country for details). When the auto button is pressed, only "NA" is displayed on the panel.

Follow the procedure below to set up the angle increments for the **Auto Mode**.

Service Mode No.	Item
n.18	Angle increments setting

When using the Auto Mode, the angle value increases and decreases according to the increments setting (default: 1 degree).

The angle increments can be set **from 1 to 5 degrees**.

To change the angle increments setting,

1. Select **n.18** and press the jog dial. The default angle increment "001" is displayed on the control panel, as shown in the right figure.



2. Turn the jog dial to adjust the angle increments you want.
3. Press the dial again and hold it until you hear a beep.
4. Restart the device to apply the new changes.

5.3.6 Waiting Time Setting for the Sleep Mode

Follow the procedure below to set up the waiting time for Sleep Mode.

Service Mode No.	Item
n.19	Waiting time setting for Sleep Mode

To change the waiting time for Sleep Mode,

1. Select **n.19** and press the jog dial. The default time “**005**” (5 minutes) is displayed on the control panel, as shown in the right figure.



2. Turn the jog dial to change the time (The selection is available from **1 to 999** minutes).
3. Press the dial again until you hear a beep.
4. Restart the device to apply the new changes.

5.3.7 Password Setting

Follow the procedure below to change the password.

Service Mode No.	Item
n.20	Password Setting

To change the password,

1. Select **n.20** and press the jog dial. The default password **"000"** is displayed on the control panel, as shown in the right figure.



2. When the first digit flashes, turn the jog dial to change the password and then save it by pressing the jog dial.
3. Follow the same procedure for the next two digits.
4. Press the dial until you hear a beep.
5. Restart the device to apply the new changes.

5.3.8 Cone Type Setting

Follow the procedure below to change the cone type.

Service Mode No.	Item
n.21	Cone Type Setting

To change the cone type,

1. Select **n.21** and press the jog dial. Currently set cone type is displayed on the screen.



2. Each number corresponds to the cone type as the table below.

001	Ø 6 Round Cone (Default)
002	3 x 2 Rectangular Cone
003	3 x 4 Rectangular Cone

3. Turn the jog dial to select the cone type and press the jog dial until you hear a beep.
4. Restart the device to apply the new changes.

IMPORTANT

Changing the cone type affects the amount of dose and the DAP value displayed after each exposure. Refer to **A.3 X-ray Dose Data** for the DAP value of each cone type.

5.3.9 DAP Display Mode On/Off

Follow the procedure below to change the DAP Display Mode.

Service Mode No.	Item
n.22	DAP Display On
n.23	DAP Display Off (Default)

To activate or deactivate the DAP display mode,

1. Select **n.22** or **n.23** and press the jog dial.

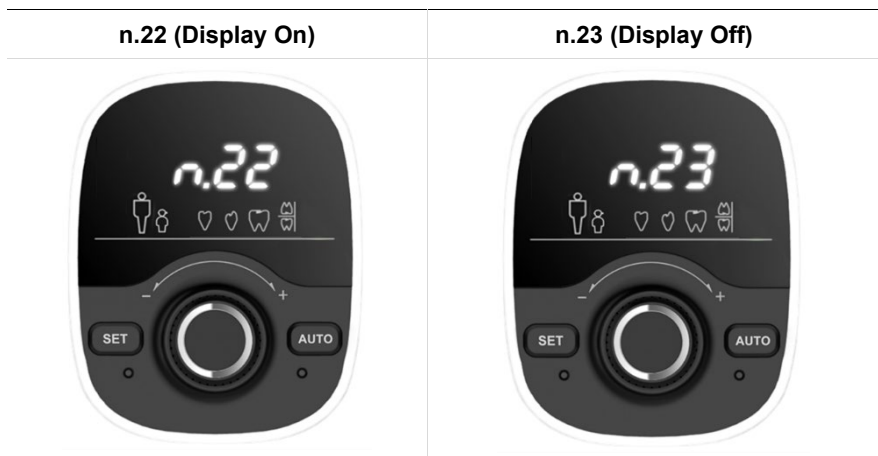

2. "YES" is displayed on the screen.



3. Press the jog dial until you hear a beep.
4. Restart the device to apply the new changes.

5.3.10 DAP Display Time Setting

Follow the procedure below to configure the time for DAP Display Mode.

Service Mode No.	Item
n.24	DAP Display Time Setting

To change the DAP display time,

1. Select **n.24** and press the jog dial.



2. The display time can be adjusted between 001 to 030 by rotating the jog dial as the table below.

001 ~ 030 (Default : 010)	1 ~ 30 second(s), ± 1 sec. increment (Default : 10 seconds)
------------------------------	--

3. Press the jog dial until you hear a beep.
4. Restart the device to apply the new changes.

NOTICE

Regardless of the preset DAP display time, operator can always skip the DAP display after the exposure by pressing jog dial once.

This Page is Left Blank Intentionally

6. Troubleshooting

In instances of abnormal operation, error messages will be displayed on the Control Panel. If a problem persists, please request assistance from the customer support information services.

Error Messages

NOTICE

A.0X: A problem occurred, and the system performs the correction automatically. This alarm clears after the correction is completed.

E.0X: An error occurred. Turn the power off, and then turn it back on. If the error persists, contact your Service Representative.

Error Code	Check Parameter	Description
E.02	X-ray Generator	An error related to X-ray exposure is not possible to exposure X-ray in the state while "E.02", "E.03", "E.04", "E.05" where power is maintained. After an X-ray exposure-related error occurs, when the equipment is turned off and turned on, X-ray exposure is normally performed.
E.03		
E.04		
E.05		
A.06	X-ray Generator	Appears when the system needs cooling time due to continuous operation. This alarm clears when the system temperature goes down to normal.
A.07	System	Appears when the Remote Exposure Switch has been held down. Release the switch.
A.08	User	Appears when the exposure button has been pressed and released before the X-ray exposure finished with the default exposure time. Press and hold the exposure button for the duration of the exposure time.

Troubleshooting

Problem	Cause	Solution
Equipment is not turned on.	The power switch is not turned on properly.	Turn the equipment power switch off and turn it back on.
	Battery discharged	Recheck after charging the battery with a charger.
	Battery cable is not connected correctly.	Contact your Service Representative.
	Defective battery	Contact your Service Representative.
Control Panel is not turned on.	Defective mainboard	Contact your Service Representative.
	Internal cable disconnected	Contact your Service Representative.
No X-ray emission	The generator is cooling.	Wait for the cooling time (refer to 'Duty Cycle' on page 70).
	Defective Remote Exposure Switch	Contact your Service Representative.
	Internal cable disconnected	Contact your Service Representative.
	Defective generator	Contact your Service Representative.
	Tube lifecycle termination	Contact your Service Representative.
X-ray emission works, but exposure is too light or completely white.	The equipment has been positioned incorrectly.	Adjust the position of the equipment.
	Exposure time is too long.	Decrease the exposure time.
	The receptor is facing the the wrong way.	Reposition the receptor.
X-ray emission works, but the exposure is too dark.	Exposure time is too short.	Increase the exposure time.

7. User Maintenance

To ensure that the equipment operates at maximum efficiency, it is recommended to perform the following procedures for the customer's routine maintenance activities.

Maintenance Task Checklist



Always turn off the equipment before performing any maintenance.

Tasks	Period
Wipe all components in contact with the patient and operator using a soft cloth.	Daily
Wipe the outer covers of the equipment with a dry cloth at the end of each day's operation.	Daily
Ensure that the main power button has been turned off after using the equipment.	Daily
Ensure the audible signal is audible, and the X-ray exposure light is visible when you perform an exposure.	Daily
Ensure that the wall framework is securely attached to the wall.	Daily
Ensure that the yellow (exposure) indicator light turns on when the exposure button is pressed.	Daily
Ensure that the power cable does not have cuts or abrasions.	Monthly
Ensure that all cable connectors are not mechanically defective.	Monthly
Ensure that the control panel has no defects.	Monthly
Ensure that the power cable does not have cuts or abrasions.	Monthly
Ensure that all visible labels are intact and legible.	Monthly



DO NOT use detergents or solvents to clean the outer covers of the equipment.



If any defects are found, do not operate the equipment since it has to be handled by a qualified person. Contact your Service Representative.

This Page is Left Blank Intentionally

8. Cleaning and Disinfection

8.1 Cleaning



Before cleaning, turn off the device for your safety.

When selecting a cleaner to clean the device, follow the cautions below:

- Your cleaner may contain powerful chemicals that could harm the equipment and the user's health. Verify the cleaner ingredients before using it.
- Do not use cleaners or disinfectant agents containing Phenol, acetic acid, peroxide, or other oxygen splitting agents, sodium hypochlorite, isopropyl alcohol(2-propanol, isopropanol) or iodine-splitting agents.
- Use cleaners or disinfectant agents that are alcohol-free and non-corrosive.

When cleaning the device, follow the precautions below:

- Wear safety gloves when handling cleaning or disinfectant agents.
- Before using chemicals, gently wipe away dust and dirt using a soft and lint-free cloth.
- Follow the provided instructions for the cleaning or disinfectant agent.
- Ensure that cleaning or disinfectant agent does not enter the device.
- Avoid directly spraying the cleaning or disinfectant agent onto the device. Always apply the agent to a clean cloth and gently wipe the device with it.
- Do not use sponge to clean the device.

8.2 Disinfection



Before disinfecting, turn off the device for your safety.

When disinfecting the device, follow the precautions below:

- Use disinfectants that comply with the regulations and requirements of the country where the device is used or those that have been verifiably tested and approved for their bactericidal, fungicidal, and virucidal properties.
- Sterilize and disinfect the device parts and its accessories that frequently contact with patients and operators.
- Avoid using UV systems to disinfect the device as this can cause discoloration.
- Using unsuitable cleaning or disinfectant agents and procedures can damage the device and its accessories.
- Avoid mixing different cleaning or disinfectant agents when cleaning the device as this can lead to damage.
- Use a non-alcoholic, chlorine dioxide-based disinfectant.

9. Disposing of the Unit

To reduce environmental contamination, this equipment is designed to be as safe as possible to use and dispose of. Many components of this equipment are environment-friendly and can be recycled.

All parts and components that contain hazardous materials must be disposed of by disposal regulations. (IEC 60601-1 Clause 7.9.2.15)

Part	Material	Recyclable	Waste Disposal Site	Hazardous waste; Needs Separate Collection
Covers	Plastics	•		
Boards		•		
Cables and transformer	Copper	•		
Packing	Polystyrene	•		
	Cardboard	•		
	Paper	•		
X-ray tube				•
Other parts			•	

IMPORTANT

Observe all regulations relevant to the disposal of waste in your country.



This symbol on the product and accompanying documents mean that used electrical and electronic equipment (WEEE) should not be mixed with general household waste.

For professional users in the European Union

If you wish to discard electrical and electronic equipment (EEE), please contact your dealer or supplier for further information.

For disposal in countries outside of the European Union

This symbol is only valid in the European Union (EU). If you wish to discard this product, please contact your local authorities or dealer and ask for the correct method of disposal.

This Page is Left Blank Intentionally

10. Product Specifications

10.1 Mechanical Specifications

Dimensions

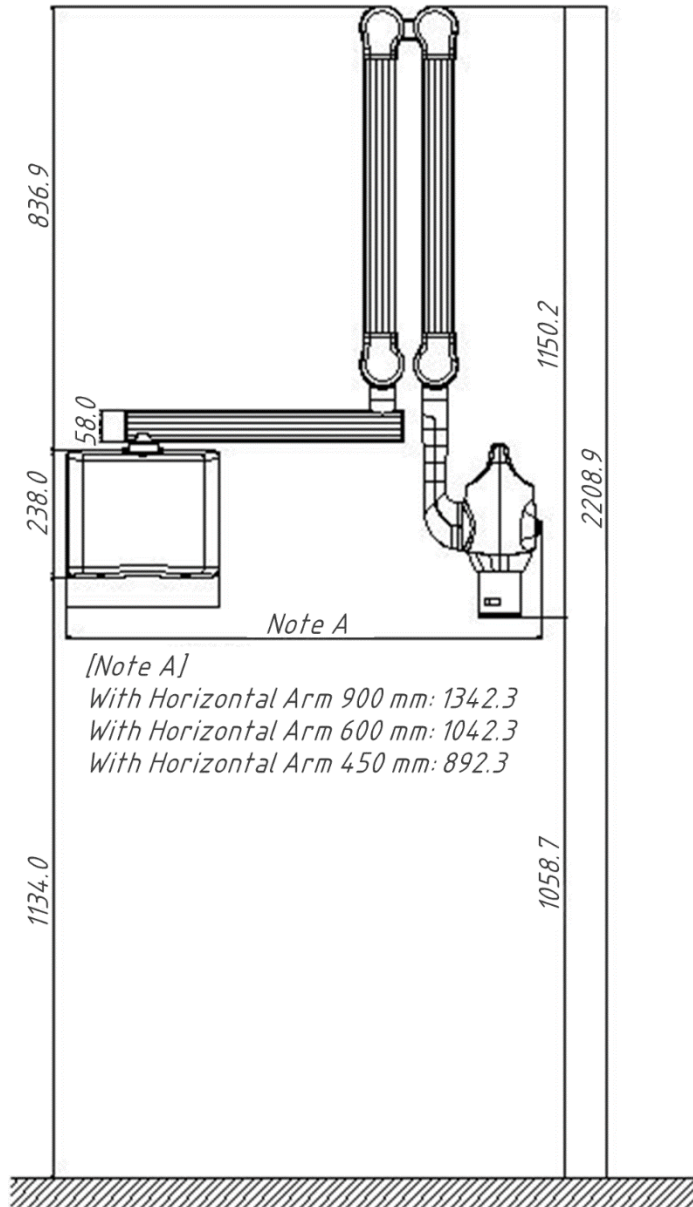

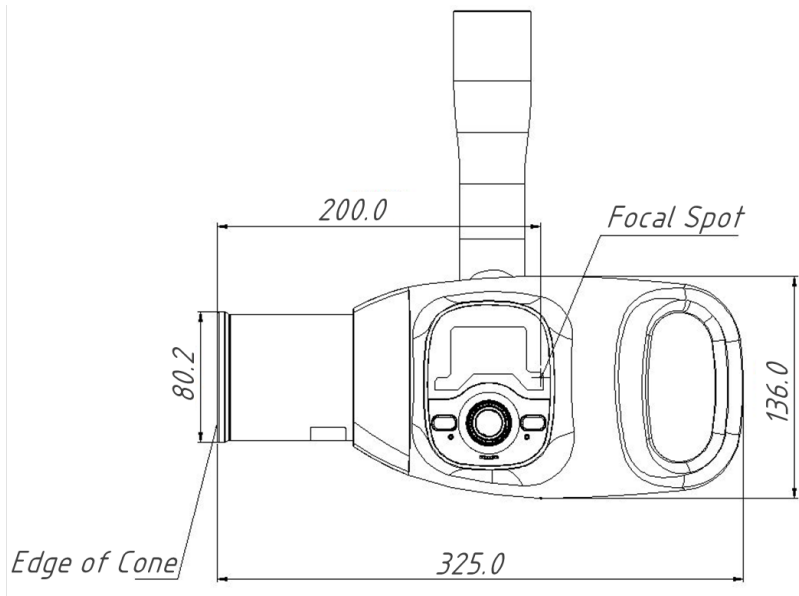
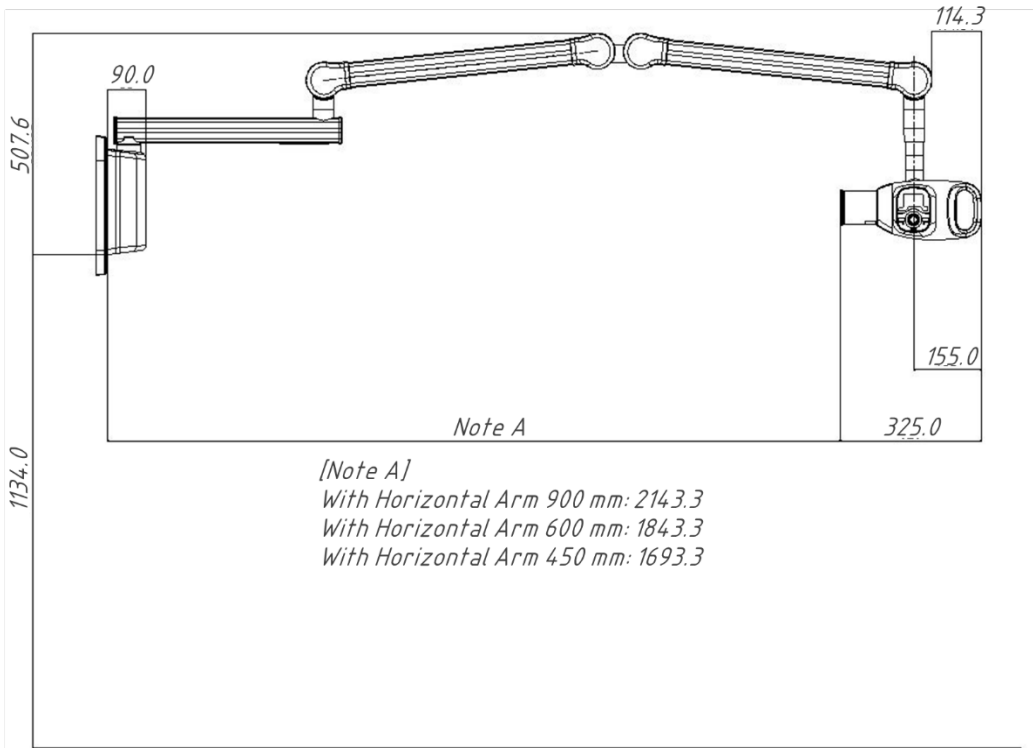

10. Product Specifications

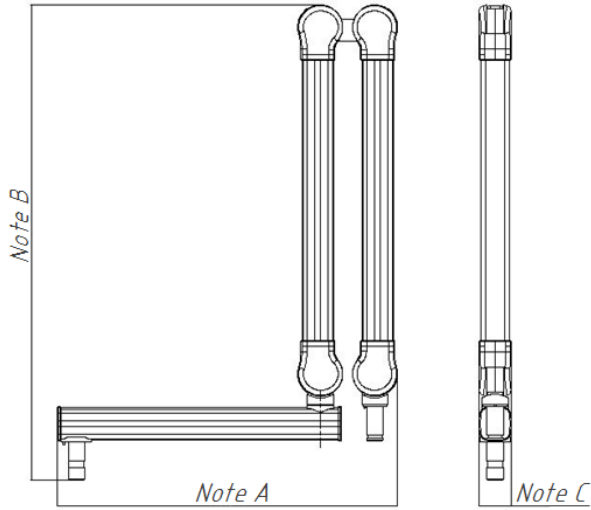

Horizontal Arm Length	Note A (L)	Note B (H)	Note C (W)
900 mm	1077.0	892.6	58.4
600 mm	777.0	892.6	58.4
450 mm	627.0	892.6	58.4

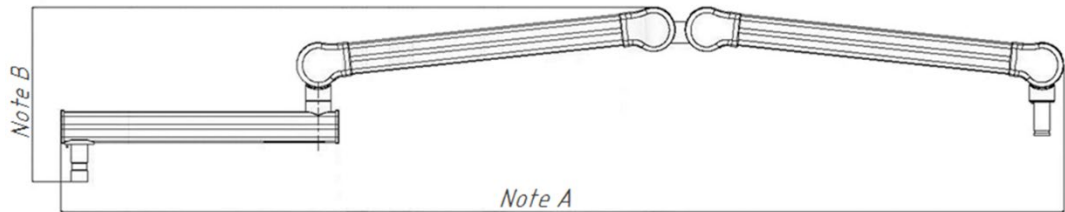

Horizontal Arm Length	Note A (L)	Note B (H)	Note C (W)
900 mm	2338.7	327.0	58.4
600 mm	2038.7	327.0	58.4
450 mm	1888.7	327.0	58.4

With Horizontal Arm 900 mm

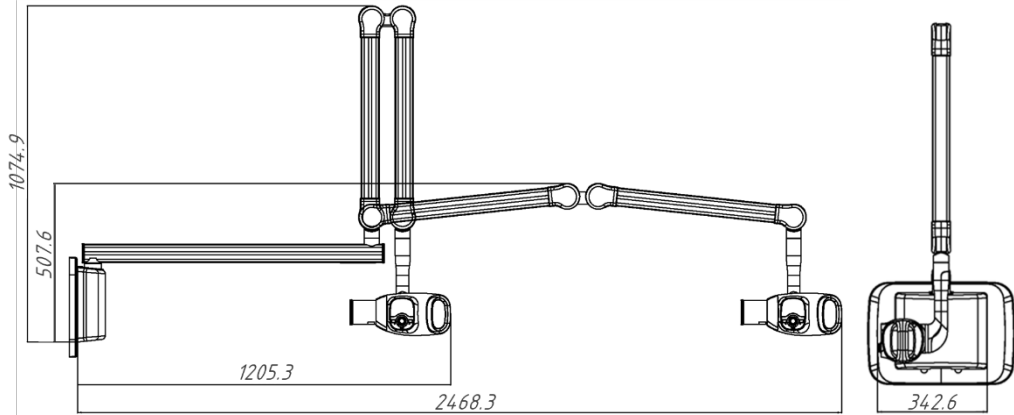

With Horizontal Arm 600 mm

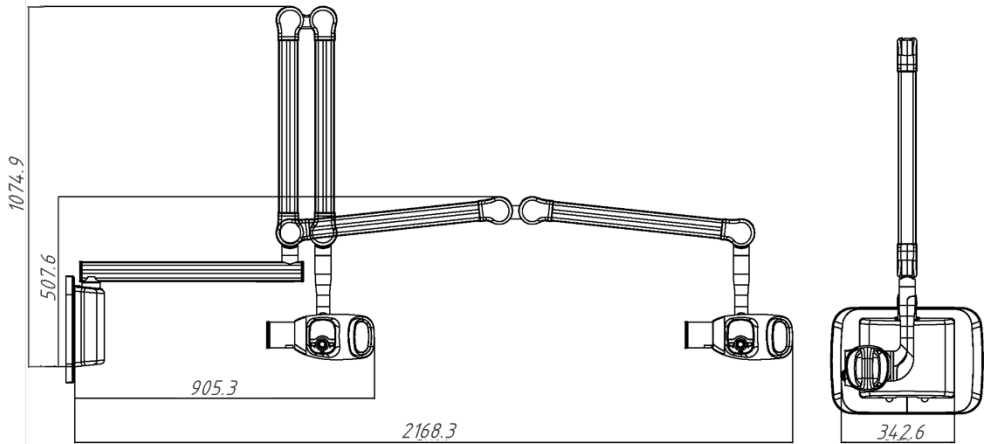

With Horizontal Arm 450 mm

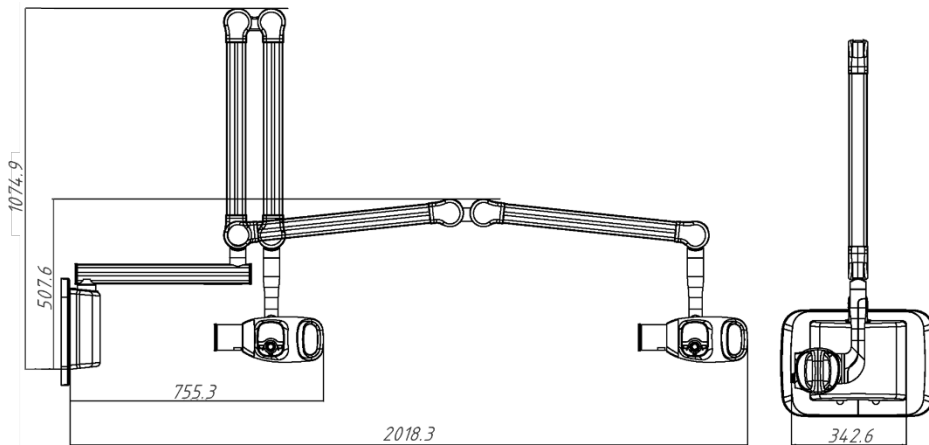

10. Product Specifications

Item	Item		Dimension (mm)	Weight (kg)
Total Assembly (including Power Box Assembly and X-ray Generator Assembly)	With Horizontal Arm:	With Scissor Arm:	-	-
	900mm	Folded	1205.3(L)x1074.9(H)x342.6(W)	17.9
		Unfolded	2468.3(L)x507.6(H)x342.6(W)	
	600mm	Folded	905.3(L)x1074.9(H)x342.6(W)	16.6
		Unfolded	2168.3(L)x507.6(H)x342.6(W)	
	450mm	Folded	755.3(L)x1074.9(H)x342.6(W)	15.9
Unfolded		2018.3(L)x507.6(H)x342.6(W)		
Total Arm Assembly	With Horizontal Arm:	With Scissor Arm:	-	-
	900 mm	Folded	1077.0(L)x892.6(H)x58.4(W)	11.45
		Unfolded	2338.7(L)x327.0(H)x58.4(W)	
	600 mm	Folded	777.0(L)x892.6(H)x58.4(W)	10.6
		Unfolded	2038.7(L)x327.0(H)x58.4(W)	
	450 mm	Folded	627.0(L)x892.6(H)x58.4(W)	10.15
Unfolded		1888.7(L)x327.0(H)x58.4(W)		
Horizontal Arm Assembly	900 mm		976.0(H) x 151.2(V) x 58.3(W)	3.65
	600 mm		676.0(H) x 151.2(V) x 58.3(W)	2.8
	450 mm		526.0(H) x 151.2(V) x 58.3(W)	2.35
Scissor Arm Assembly			797.6(W) x 184.0(L) x 58.4(H)	7.8
Power Box Assembly			287.8(W) x 238.0(L)	3.1
X-ray Generator Assembly			325.0(W) x 299.5(L) x 222.7(H)	2.4
X-ray Beam Limiting Device	X-ray Beam Area (mm)	Round type	FOV: $\varnothing 60$	0.013
		Rectangular type	FOV: 20 x 30 (30 x 20), 40 x 30 (30 x 40)	0.040
	SSD(Source to Skin Distance) (mm)		Min. 200	-

10.2 Technical Specifications

X-ray Generator

	Item	Description
High Voltage Generator (Assembly)	Model	DG- S0102V1
	Rated output power	Max. 0.2 kW
	Duty Cycle	1:60 or more (Exposure time: Interval time)
	Cooling Protection	Thermistor $\geq 65^{\circ}\text{C}$
	Inherent Filtration	1.8 mm Al / 65 kV
	Total Filtration	Min. 1.5 mm Al
	Type	Inverter Type
	Tube Voltage	55-65 kV
	Tube Current	1.0-3.0 mA
X-ray Tube	Manufacturer	VATECH Co., Ltd.
	Model	V1-650304 (Stationary Anode type)
	Version	2.0
	Focal spot size	0.4 mm (IEC 60336)
	Anode heat contents	Max. 2.7 kJ
	Maximum Anode Heat Dissipation	200 W
	Target Material	Tungsten
	Target Angle	12.5°
	Inherent Filtration	Min. 1.5 mm Al
	X-ray Coverage	70 mm at SID 200 mm
	Tube Voltage	Max. 65 kV
	Tube Current	Max. 3.0 mA

X-ray Tube Characteristics

1) Maximum rating chart

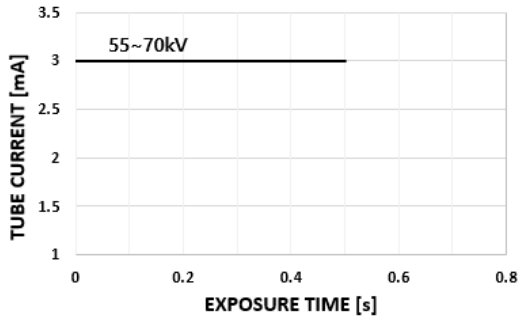

2) Emission characteristics

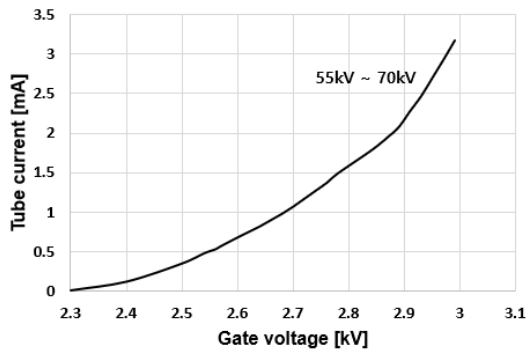

3) Heating and cooling curves of the X-ray tube

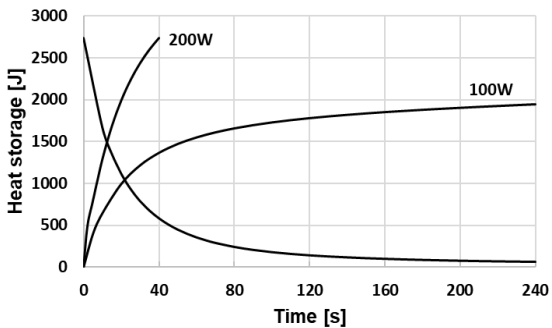

4) Tube Dimensions [mm]

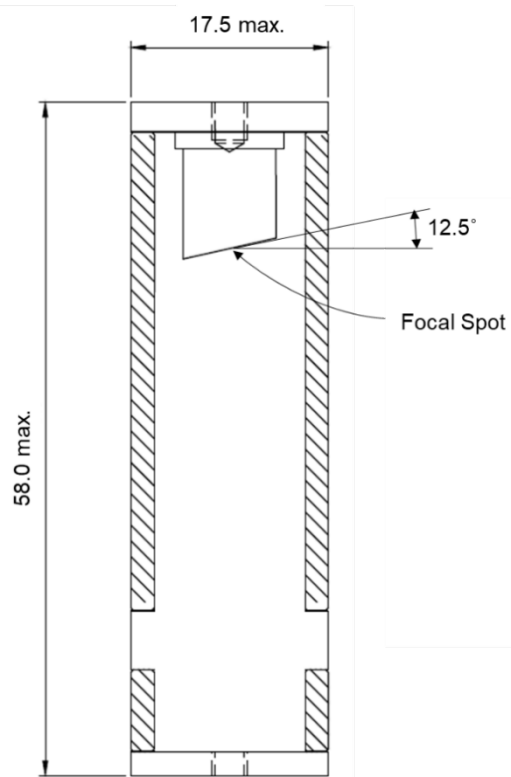

10.3 Electrical Specifications

Item	Description
Power Supply Voltage	100-240 V ~
Frequency	50/60 Hz (Single phase)
Power Rating	4-2 A
Tube Voltage	65 kV fixed ($\pm 3 \%$)
Tube Current	3.0 mA
Accuracy Error	< kVp +10 %, < mA + 20 %, < s $\pm 5 \%$ or 20 ms

- The input line voltage depends on the local electrical distribution system.
- Allowable input voltage fluctuation requirement: $\pm 10 \%$
- Mode of operation: Continuous operation with cyclic loading—This equipment needs a rest time of at least 60 times the exposure time before starting the next exposure.
- Standard: Permanently installed, Option: AC Power Cable

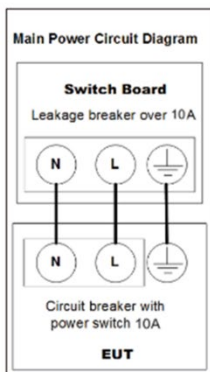
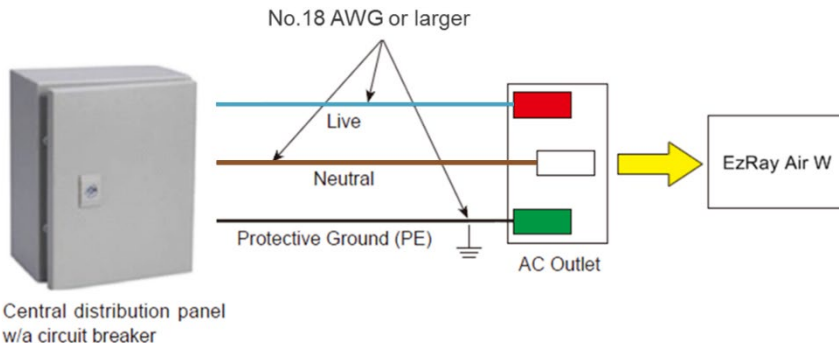

NOTICE	<ul style="list-style-type: none"> ▪ To assure line voltage quality, a separate 3-core grounded power cable connected directly to a central distribution panel with an over-current circuit breaker rated for 10A must be used. ▪ The mains resistance should not exceed 0.5 Ω.
NOTICE	The system is available with a fixed tube current specification based on the user's choice.
NOTICE	Power Supply is specified as a part of the ME EQUIPMENT.
NOTICE	Power plugs may have various specifications for each country.

10.4 Environmental Specifications

	Item	Description
During operating	Temperature	10 ~ 35 °C
	Relative humidity	30 ~ 75 %
	Atmospheric pressure	860 ~ 1060 hPa
Transport and storage	Temperature	-10 ~ 60 °C
	Relative humidity	10 ~ 75 % non-condensing
	Atmospheric pressure	860 ~ 1060 hPa

Appendix

A.1 Using the Rotating Rectangular Cover

Rotating Rectangular Cover rotates in 360 degrees.
Rotating Rectangular Cover consists of the Outer Ring and the Inner Ring.

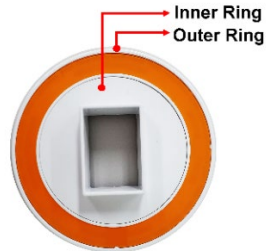

The Outer Ring rotates in 90-degree increments.

IMPORTANT

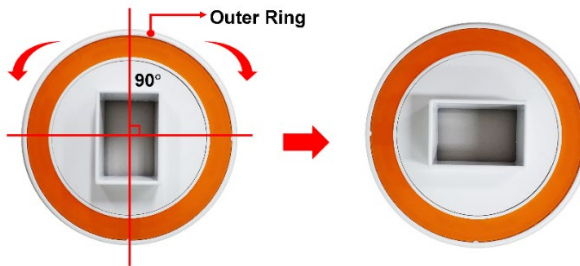

The Inner Ring rotates in 10-degree increments.

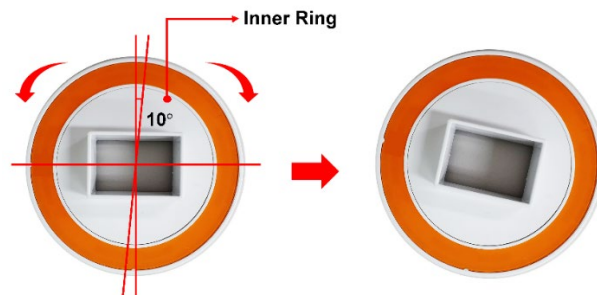

1. Assemble the Rotating Rectangular Cover to the Cone of the Main body.

NOTICE

For assembling the Rotating Rectangular Cover to the Cone, turn the Rotating Rectangular Cover 45 degrees and check the Click sound to make sure the assembly is complete.

2. Turn the Outer Ring of the Rotating Rectangular Cover to adjust the angle roughly.
3. Turn the Inner Ring of the Rotating Rectangular Cover to fine-tune the angle.











NOTICE

The disassembly method of the Rotating Rectangular Cover is the same as the assembly method. Refer to the NOTE mentioned below stage 1.

A.2 Tables of Exposure Times (Default)

The following exposure timetables were established with a unit equipped with a cone that corresponds to a focus-to-skin distance of 200 mm (8 inches), respectively.

➤ 65 kV, 3.0 mA

Receptor	Patient	Teeth		Angle of inclination	SSD: 200 mm (8 inches)		
					kV	mA	s
Sensor 	Adult 	Incisor		Maxilla: +45° Mandible: -25°	65	3.0	0.14
		Canine		Maxilla: +45° Mandible: -20°	65	3.0	0.16
		Molar/ Premolar		Maxilla: +30° Mandible: -5°	65	3.0	0.18
		Bitewing		+5° ~ +8°	65	3.0	0.19
	Child 	Incisor		Maxilla: +45° Mandible: -25°	65	3.0	0.11
		Canine		Maxilla: +45° Mandible: -20°	65	3.0	0.13
		Molar/ Premolar		Maxilla: +30° Mandible: -5°	65	3.0	0.15
		Bitewing		+5° ~ +8°	65	3.0	0.16

A.3 X-ray Dose Data

The X-ray dose data is extracted from the X-ray Dose Test Report for the **EzRay Air Wall (VEX-S300W)**. The IEC collateral standards have measured the X-ray doses of **EzRay Air Wall (VEX-S300W)** in the test report. The **EzRay Air Wall (VEX-S300W)** has been designed by Part 1. General Requirements for Safety, IEC 60601-1-3.

Test Condition	
Model Name	EzRay Air Wall (VEX-S300W)
Tube Model Name	V1-650304
Generator Model Name	DG-S0102V1 (Inverter type)
Loading Factor	65 kV, 3.0 mA

Test Equipment			
Instrument	Manufacturer	Model	S/N
Multi Dose Meter	UNFORS	Unfors Xi R/F&MAM	161834

■ X-ray Dose Table

DAP (Min. to Max. Exposure Time)

65 kV / 3 mA / SSD 200 mm				
Exposure time (sec)	DOSE (mGy)	Dose (mGy.cm ²)		
		FOV: Ø 6 cm	FOV : 3 x 2 cm	FOV : 3 x 4 cm
0.05	0.231	6.52	1.39	2.77
0.10	0.462	13.04	2.77	5.54
0.20	0.923	26.08	5.54	11.08
0.30	1.384	39.13	8.31	16.61
0.40	1.846	52.17	11.08	22.15
0.50	2.307	65.21	13.84	27.69

DAP (Default Exposure Time)

65 kV / 3 mA / SSD 200 mm						
Mode	Exposure time (sec)	DOSE (mGy)	Dose (mGy.cm ²)			
			FOV: Ø 6 cm	FOV : 3 x 2 cm	FOV : 3 x 4 cm	
Adult	Incisor	0.14	0.646	18.26	3.88	7.75
	Canine	0.16	0.738	20.87	4.43	8.86
	Molar/Premolar	0.18	0.831	23.48	4.98	9.97
	Bitewing	0.19	0.877	24.78	5.26	10.52
Child	Incisor	0.11	0.508	14.35	3.05	6.09
	Canine	0.13	0.600	16.96	3.60	7.20
	Molar/Premolar	0.15	0.692	19.56	4.15	8.31
	Bitewing	0.16	0.738	20.87	4.43	8.86

■ Leakage Dose

Scope

IEC 60601-2-65 203.12.4

Requirements

In the LOADING STATE, the AIR KERMA due to LEAKAGE RADIATION from X-RAY SOURCE ASSEMBLIES, 1 m from the FOCAL SPOT, average over an area of 100 cm² of which no principal linear dimension exceeds 20 cm when operated at the NOMINAL X-RAY TUBE VOLTAGE under the condition of LOADING corresponding to the reference LOADING conditions, shall not exceed 0.25 mGy in one hour.

Leakage Dose	Permissive Range
65 kVp, 3.0 mA, 0.5 s (Max. Exposure Condition) At Focal Spot to Distance 1 m Duty Cycle 1 : 60	< 0.25 mGy/h

Test Equipment			
Instrument	Manufacturer	Model	S/N
X / Gamma Survey Meter	Radcal Co.	9015/10X5-180	91-1470/19069

Results

The following exposure timetables were established with a unit equipped with a cone that corresponds to a focus-to-skin distance of 200 mm (8 inches), respectively. When the leakage doses have been measured with each cover type (default, rectangular 2x3, and rectangular 4x3), all the results have been ND (Not Detected).

The raw data about the results are shown in the following table.

Result (Horizontal Plane)

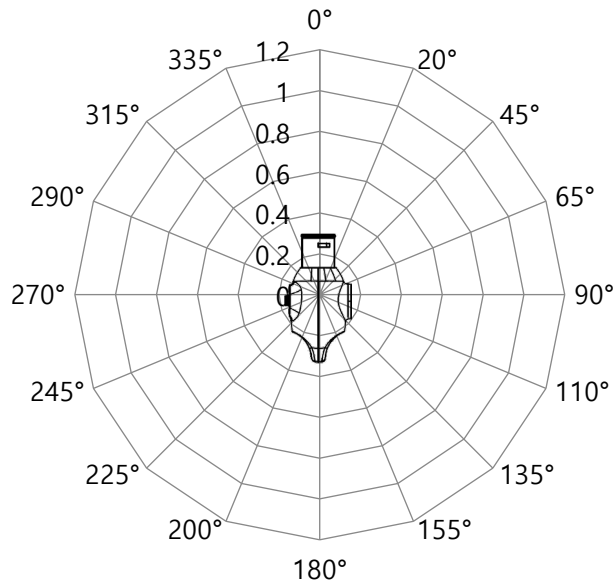

Direction	Default type	Rectangular 2x3	Rectangular 4x3
	[mGy/h]	[mGy/h]	[mGy/h]
0°	ND	ND	ND
20°	ND	ND	ND
45°	ND	ND	ND
65°	ND	ND	ND
90°	ND	ND	ND
110°	ND	ND	ND
135°	ND	ND	ND
155°	ND	ND	ND
Direction	Default type	Rectangular 2x3	Rectangular 4x3
	[mGy/h]	[mGy/h]	[mGy/h]
180°	ND	ND	ND
200°	ND	ND	ND
225°	ND	ND	ND
245°	ND	ND	ND
270°	ND	ND	ND
290°	ND	ND	ND
315°	ND	ND	ND
335°	ND	ND	ND

Result (Vertical Plane)

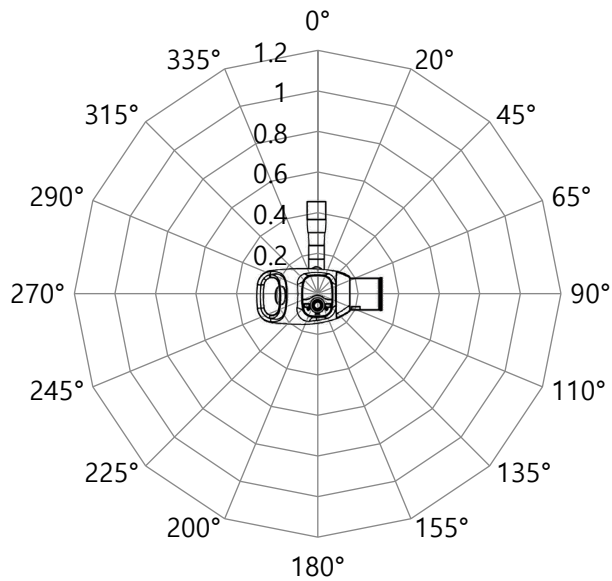

Direction	Default type	Rectangular 2x3	Rectangular 4x3
	[mGy/h]	[mGy/h]	[mGy/h]
0°	ND	ND	ND
Direction	Default type	Rectangular 2x3	Rectangular 4x3
	[mGy/h]	[mGy/h]	[mGy/h]
20°	ND	ND	ND
45°	ND	ND	ND
65°	ND	ND	ND
90°	ND	ND	ND
110°	ND	ND	ND
135°	ND	ND	ND
155°	ND	ND	ND
180°	ND	ND	ND
200°	ND	ND	ND
225°	ND	ND	ND
245°	ND	ND	ND
270°	ND	ND	ND
290°	ND	ND	ND
315°	ND	ND	ND
335°	ND	ND	ND

- ND: Not Detected. The detection limit is 0.00001 mGy per exposure.

■ Scattered Dose

Scope

IEC 60601-2-65 203.13

Requirements

ME EQUIPMENT shall be provided with means to optionally allow actuation of the IRRADIATION from a PROTECTED AREA after installation.

Relevant instructions shall be given in the ACCOMPANYING DOCUMENTS.

Results

The following exposure timetables were established with a unit equipped with a cone that corresponds to a focus-to-skin distance of 200 mm (8 inches), respectively.

Test Equipment			
Instrument	Manufacturer	Model	S/N
X / Gamma Survey Meter	Radcal Co.	9015/10X5-180	91-1470/19069

Method
<p>PMMA Phantom aligned to 280 mm away from Focal Spot (with Position Indicating Device (80 mm)) 65 kVp, 3.0 mA, 0.5 s (Max. Exposure Condition) Measure point: 2,000 mm from PMMA Phantom</p>

Result (Horizontal Plane)

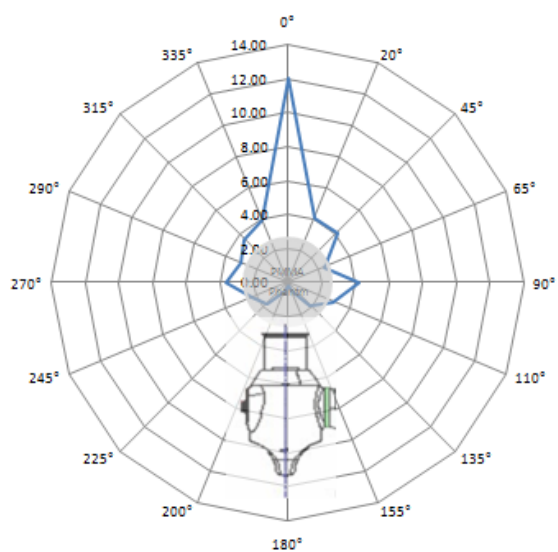

Direction [°]	[μGy/h]
0°	11.41
20°	3.90
45°	3.97
65°	2.24
90°	4.02
110°	2.75
135°	1.80
155°	0.46
180°	0.17
200°	0.48
225°	1.62
245°	2.20
270°	3.50
290°	2.87
315°	3.44
335°	3.78

Result (Vertical Plane)

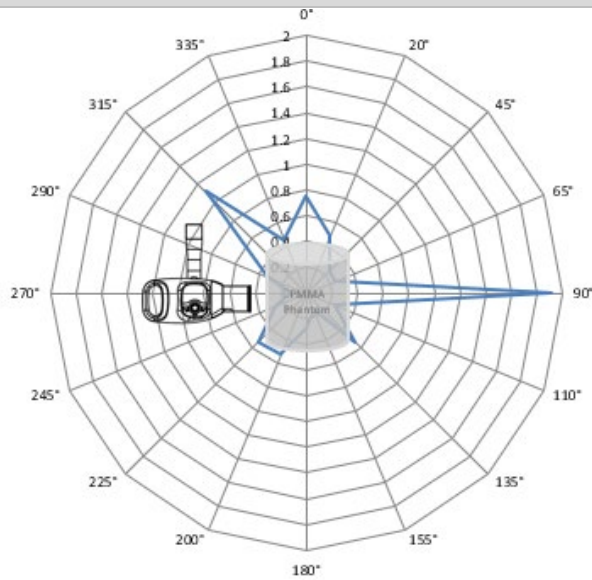

Direction [°]	[μGy/h]
0°	7.20
20°	3.58
45°	4.83
65°	5.48
90°	9.52
110°	5.77
135°	4.15
155°	4.12
180°	5.86
200°	3.35
225°	0.89
245°	0.43
270°	0.09
290°	0.31
315°	1.43
335°	4.85

A.4 Electromagnetic Compatibility (EMC) Information

Guidance and manufacturer's declaration - electromagnetic emissions

The VEX-S300W is intended for use in the electromagnetic environment specified below. The customer or the user of the VEX-S300W should assure that it is used in such an environment.

Emissions test	Compliance	Electromagnetic environment - guidance
RF emissions CISPR 11	Group 1	The VEX-S300W uses RF energy only for its internal function. Therefore, its RF emissions are very low and are not likely to cause any interference in nearby electronic equipment.
RF emissions CISPR 11	Class A	The VEX-S300W is suitable for use in all establishments and may be used in domestic establishments and those directly connected to the public low-voltage power supply network that supplies buildings used for domestic purposes.
Harmonic emissions IEC 61000-3-2	Applicable	
Voltage fluctuations / flicker emissions IEC 61000-3-3	Applicable	

NOTE) the actual RF shielding effectiveness and filter attenuation of the shielded location must be verified to ensure that they meet or exceed the specified minimum values.

Guidance and manufacturer's declaration - electromagnetic immunity

The VEX-S300W is intended for use in the electromagnetic environment specified below. The customer or the user of the VEX-S300W should assure that it is used in such an environment.

Immunity test	IEC 60601 Test level	Compliance level	Electromagnetic environment -guidance
Electrostatic discharge (ESD) IEC 61000-4-2	±6 kV Contact ±8 kV air	±6 kV Contact ±8 kV air	Floors should be wood, concrete, or ceramic tile. If floors are covered with synthetic material, the relative humidity should be at least 30 %.
Electrical fast transient/burst IEC 61000-4-4	±2 kV for power supply lines ±1 kV for input/output lines	±2 kV for power supply lines ±1 kV for input/output lines	The main power quality should be that of a typical commercial or hospital environment.
Surge IEC 61000-4-5	±1 kV line(s) to line(s) ±2 kV line(s) to earth	±1 kV line(s) to line(s) ±2 kV line(s) to earth	Main power quality should be that of a typical commercial or hospital environment.
Voltage dips, short interruptions and voltage variations on power supply input lines IEC 61000-4-11	< 5 % U_T (> 95 % dip in U_T) for 0.5cycle 40 % U_T (60 % dip in U_T) for 5 cycle, 6 cycle 70 % U_T (30 % dip in U_T) for 25 cycle, 30 cycle <5 % U_T (< 95 % dip in U_T) for 5 s	< 5 % U_T (> 95 % dip in U_T) for 0.5cycle 40 % U_T (60 % dip in U_T) for 5 cycle, 6 cycle 70 % U_T (30 % dip in U_T) for 25 cycle, 30 cycle <5 % U_T (< 95 % dip in U_T) for 5 s	Main power quality should be that of a typical commercial or hospital environment. If the user of the VEX-S300W image intensifier requires continued operation during power mains interruptions, it is recommended that the VEX-S300W be powered from an uninterruptible power supply.
Power frequency (50/60 Hz) magnetic field IEC 61000-4-8	3 A/m	3 A/m	Power frequency magnetic fields should be at levels characteristic of a typical location in a typical commercial or hospital environment.

NOTE: U_T is the V a.c. mains voltage before application of the test level.

Guidance and manufacturer's declaration - electromagnetic immunity

The VEX-S300W is intended for use in the electromagnetic environment specified below. The customer or the user of the VEX-S300W should assure that it is used in such an electromagnetic environment.

Immunity test	IEC 60601 test level	Compliance level	Electromagnetic environment - guidance
Conducted RF IEC 61000-4-6	3 Vrms 150 kHz to 80 MHz	3 Vrms 150 kHz to 80 MHz	The VEX-S300W must be used only in a shielded location with a minimum RF shielding effectiveness and, for each cable that exits the shielded location, a minimum RF filter attenuation of 20 dB from 30 MHz to 230 MHz, 20 dB from 230 MHz to 1 GHz. Field strengths outside the shielded location from fixed RF transmitters, as determined by an electromagnetic site survey, should be less than 3 V/m. an Interference may occur in the vicinity of equipment marked with the following symbol:
Radiated RF IEC 61000-4-3	3 V/m 80 MHz to 2.7 GHz	3 V/m 80 MHz to 2.7 GHz	

NOTE 1) These guidelines may not apply in all situations. Electromagnetic propagation is affected by absorption and reflection from structures, objects, and people.

NOTE 2) the actual shielding effectiveness and filter attenuation of the shielded location must be verified to assure that they meet the minimum specification.

Field strength from fixed transmitters, such as base stations for radio (cellular/cordless) telephones and land mobile radios, amateur radio, AM and FM radio broadcast and TV broadcast cannot be predicted theoretically with accuracy. To assess the electromagnetic environment due to fixed RF transmitters, an electromagnetic site survey should be considered. If the measured field strength outside the shielded location in which the VEX-S300W is used exceeds 3V/m, the VEX-S300W should be observed to verify normal operation. If abnormal performance is observed, additional measures may be necessary, such as relocating the VEX-S300W or using a shielded location with a higher RF shielding effectiveness and filter attenuation.

A.5 Abbreviations

Acronym	Name
AL	Aluminum
EMC	Electromagnetic Compatibility
ESD	Electrostatic Discharge
FOV	Field of View
IEC	International Electrotechnical Commission
ISO	International Standards Organization
LED	Light-Emitting Diode
ME	Medical Electrical
PMMA	PolyMethylMethAcrylate
RF	Radio Frequency
SID	Source to Image receptor Distance
SIP	Signal Input Part
SOP	Signal Output Part
SSD	Source to Skin Distance

© 2018 VATECH Co., Ltd.

All rights reserved.

The documentation, brand name, and logo used in this manual are copyrighted.

No part of this manual may be reproduced, transmitted, or transcribed without the expressed written permission of the manufacturer.

We reserve the right to make any alterations that may be required due to technical improvement. For the most current information, contact your VATECH representative.

Manufactured by VATECH Co., Ltd.

Tel: (+82) 1588 9510

Email: gcs@vatech.co.kr

Website: www.vatech.com

Head Quarters Address: 13, Samsung 1-ro 2-gil, Hwaseong-si, Gyeonggi-do, 18449, Korea

Factory Address: 13, Samsung 1-ro 2-gil, Hwaseong-si, Gyeonggi-do, 18449, Korea



The CE symbol grants this product complies with the European Directive for Medical Devices 93/42/EEC as amended by 2007/47/EC as a class IIb device.



Authorized EU Representative: VATECH GLOBAL FRANCE SARL
49 Quai de Dion Bouton, AVISO A 4ème étage, 92800 Puteaux, France
Tel: +33 1 64 11 43 30
Fax: +33 1 64 11 43 39

Australia Sponsor; VATECH Medical Pty Ltd.
ABN: 78 155 258 923
Address: Suite 5.04 Gateway Business Park 63-79 Parramatta Road,
Silverwater, NSW 2128
Tel : 1300 789 454 (+61 2 9644 4866)
E-mail: info@vatechanz.com.au

