

Green X 12

User manual

Model : PHT-75CHS
Version : 1.01

- English



Full version

vatech

Notice

Thank you for purchasing the **Green X 12™ (Model: PHT-75CHS)** extra-oral imaging system.

Green X 12™ (Model: PHT-75CHS) is one of the manufacturer's Green CT product series for aiding dental professionals in providing excellent care in a safe environment that promotes healing.

Green X 12™ (Model: PHT-75CHS) is an advanced digital diagnostic system that incorporates PANO, CEPH (Optional), CBCT, and 3D MODEL Scan imaging capabilities into a single system.

This manual describes how to operate the **Green X 12™ (Model: PHT-75CHS)** system. It is recommended that you thoroughly familiarize yourself with this manual to effectively use this equipment.

Observe all cautions, safety messages, and warnings in this manual.

Due to constant technological improvement, the manual may not contain the most updated information and is subject to change without prior notice to the persons concerned. For further information not covered in this manual, please contact us at:

VATECH Co., Ltd.

Phone: +82-1588-9510

E-mail: gcs@vatech.co.kr

This document is originally written in English.

Green X 12™ (Model: PHT-75CHS) is referred to as "equipment" in this manual.

Manual Name: Green X 12™ (Model: PHT-75CHS) User Manual

Version: 1.01

Publication Date: 2023-03

Document Number : VDH-UM-085(C)

This Page Intentionally Left Blank

Table of Contents

Notice		iii
Table of Contents		v
1.	Introduction	1
	1.1 Overview	1
	1.2 Indications for Use	1
	1.3 Intended Purposes	2
	1.4 Intended User Profiles	3
	1.5 Contraindications	3
2.	General Information	5
	2.1 Manufacturer's Liability.....	5
	2.2 Owner and Operator's Obligations	5
	2.3 Conventions in this Manual	6
	2.4 Marks and Symbols	7
3.	Warnings and Precautions	9
	3.1 General Safety Guidelines	9
	3.2 Electricity-Related Safety Precautions	14
	3.3 Radiation Safety	16
	3.4 Warnings	17
4.	Imaging System Overview	20
	4.1 System Components.....	20
	4.2 Features	20
	4.3 Imaging System Options	21
	4.4 Operating Principles	21
	4.5 Standards and Regulations	22
	4.6 Imaging System Configuration	23
	4.7 Equipment Overview	26
5.	Imaging Software Overview	34
	5.1 PC Specifications (Recommended).....	34
	5.2 EzDent-i.....	35

	5.3	Console Software	36
6.		Getting Started	39
	6.1	Turning on the Equipment	39
	6.2	Running the Image Viewer (EzDent-i).....	40
7.		How to Acquire PANO Images	45
	7.1	Program Overview	45
	7.2	Preparing X-ray System	52
	7.3	Selecting Exposure Settings.....	54
	7.4	Patient Positioning.....	68
	7.5	Acquiring Images	75
	7.6	After Acquiring Images	76
	7.7	Checking the Acquired Images	76
8.		How to Acquire CEPH Images (Optional)	79
	8.1	Program Overview	79
	8.2	Preparing X-ray System	81
	8.3	Selecting Exposure Settings.....	82
	8.4	Patient Positioning.....	85
	8.5	Acquiring Images	93
	8.6	After Acquiring Images	94
	8.7	Checking the Acquired Images	95
9.		How to Acquire CBCT Images	96
	9.1	Program Overview	96
	9.2	Preparing X-ray System	99
	9.3	Selecting Exposure Settings.....	101
	9.4	Patient Positioning.....	119
	9.5	Acquiring Images	124
	9.6	After Acquiring Images	125
	9.7	Check the Acquired Images	125
10.		How to Acquire 3D Model Scan Images	127
	10.1	Program Overview	127
	10.2	Selecting Exposure Settings.....	128

	10.3	Model Positioning	130
	10.4	Acquiring Images	131
	10.5	Checking the Acquired Images.....	132
11.		Troubleshooting	134
	11.1	Troubleshooting	134
	11.2	Error Codes.....	135
12.		Cleaning and Disinfection	140
	12.1	Preparation.....	140
	12.2	Cleaning	141
	12.3	Disinfection	142
13.		Maintenance	144
	13.1	Regular Maintenance	144
	13.2	Maintenance Task Checklist	145
	13.3	QA Test	146
	13.4	Phantom Kit Contents	146
	13.5	QA Test Procedure.....	148
14.		Disposing of the Equipment	159
15.		Technical Specifications	161
	15.1	Mechanical Specifications	161
	15.2	Technical Specifications	164
	15.3	Electrical Specifications.....	169
	15.4	Environmental Specifications	170
16.		Appendices	172
	16.1	Recommended X-ray Exposure Tables	172
	16.2	X-ray Dose Data	185
	16.3	Leakage Dose	188
	16.4	Scattered Dose	207
	16.5	Electromagnetic Compatibility (EMC) Information	222
	16.6	Acquiring Images for Pediatric Dental Patients	224
	16.7	Abbreviations	235

This Page Intentionally Left Blank

1. Introduction

1.1 Overview

Green X 12™ (Model: PHT-75CHS) is an advanced 4-in-1 digital X-ray imaging system that incorporates PANO, CEPH (Optional), CBCT, and 3D MODEL Scan imaging capabilities into a single system.

Green X 12™ (Model: PHT-75CHS), a digital radiographic imaging system, acquires and processes multi-FOV diagnostic images for dentists. Designed explicitly for dental radiography, **Green X 12™ (Model: PHT-75CHS)** is a complete digital X-ray system equipped with imaging viewers, an X-ray generator, and a dedicated SSXI detector.

The digital CBCT system is based on a CMOS digital X-ray detector. The CMOS CT detector is used to capture 3D radiographic images of the head, neck, oral surgery, implant, and orthodontic treatment.

Green X 12™ (Model: PHT-75CHS) can also acquire 2D diagnostic image data in conventional panoramic and cephalometric modes.

1.2 Indications for Use

Green X 12™ (Model: PHT-75CHS) is intended to produce panoramic, cephalometric, or 3D digital X-ray images. It provides diagnostic details of the dento-maxillofacial, sinus, TMJ, and ENT for adult and pediatric patients. The system also utilizes carpal images for orthodontic treatment. The device is to be operated by healthcare professionals.



1.3 Intended Purposes

- Determination of the extent of lesions, tumors, cysts, etc., which cannot be adequately visualized on plain films.
- Diagnosis of foreign bodies or displaced roots involving the maxillary sinus.
- Diagnosis of bone diseases, cysts, etc., affecting the temporomandibular joints.
- Identifying the relationship of the inferior dental canal to a tooth/lesion that is to be removed.
- Assessment of fractures on the maxilla, mandible, condylar neck, and fractures of teeth where plain film imaging is equivocal.
- Visualization of the 3D anatomy of the alveolar clefts.
- Diagnosis of un-erupted teeth impacted teeth and odontomas.
- Diagnosis of root resorption of teeth.
- Assessment of cleft palate.
- Diagnosis of CRS (Chronic Rhinosinusitis).
- Assessment of complex root canal anatomy.
- Diagnosis of periapical pathology.
- Diagnosis of vertical root fracture.
- Examinations of the airways for measuring the volume and dimensions of air passages.
- Planning any surgery where a 3D analysis of the jaw is required.
- Storing Plaster Casts in 3D data

1.4 Intended User Profiles

Considerations	Requirement Description
Qualification	<ul style="list-style-type: none"> A legally qualified person such as a dentist and healthcare professional for X-ray device operation
Knowledge	<ul style="list-style-type: none"> Understanding the treatment and diagnosis of dental disease Understanding the terms and guidance of hardware and software of a diagnostic medical radiation device and recognizing device connection, installation, and operating conditions
Language understanding	<ul style="list-style-type: none"> Understanding how to use manuals (English/Korean) or Understanding other languages provided
Experience	<ul style="list-style-type: none"> Understanding the objectives and effects of the diagnosis and treatment of dental disease using diagnostic medical radiation devices Understanding of the normal operation of diagnostic medical radiation equipment Understanding the contents of the user manual

IMPORTANT

Only qualified personnel such as dentists, dental hygienists, or radiologists can use X-ray devices.

1.5 Contraindications

Do not use this device other than the intended purpose.

There are no other contraindications to it since the technology is at a controllable level in accordance with global standards.

This Page Intentionally Left Blank

2. General Information

2.1 Manufacturer's Liability

The manufacturers and retailers of this X-ray equipment assume responsibility for the safe and healthy operation of this product only when:





- A **VATECH**-authorized technician installed the equipment.
- The equipment was installed following all the cautions and conditions required for installation.
- **VATECH**-approved equipment and components are used.
- A **VATECH**-authorized agent performed all maintenance and repairs.
- The equipment was used following the instructions in the **user manual**.
- The owner or the operator did not cause damages to the equipment.

2.2 Owner and Operator's Obligations











- The owner of this equipment shall perform constancy tests at regular intervals to ensure patient and operator safety. Local X-ray safety regulations must perform these tests.
- The owner of this equipment shall perform regular inspection and maintenance of the mechanical and electrical components in this equipment to ensure safe and consistent operation (IEC 60601-1).
- The owner of this equipment shall ensure inspection and cleaning work is performed by the maintenance schedule outlined in **Chapter 12: Cleaning and Disinfection**.

2.3 Conventions in this Manual







This manual uses the following conventions to inform users. Please familiarize yourself with each convention and follow the accompanying instructions.

 WARNING	WARNING	Failure to comply with the given information may result in severe injuries to the people or damages to the equipment.
 CAUTION	CAUTION	Requires the user's immediate attention or action due to the possibility of safety issues.
IMPORTANT	IMPORTANT	Requires the user's attention because the stated action and environment may cause trouble.
NOTICE	NOTICE	Indicates useful information for users.
	RADIATION	Indicates a possible danger from radiation exposure.
	SINGLE-USE	Indicates a component that must be replaced for each new patient.
	ESD susceptibility	Indicates that an item is susceptible to damage from electrostatic discharges.

2.4 Marks and Symbols

Symbols	Description	Location
	Dangerous voltage	Powerboard /Inverter board /Monoblock
	Protective earth (Ground)	Column
	Off (power: disconnected to the Main Power Switch)	Main Power Switch
	On (power: connected to the Main Power Switch)	Main Power Switch
	Alternate Current	Label
	Type B Applied Equipment (IEC 60601-1: Degree of protection against leakage current and electric shock: Class 1 equipment)	Label
	Radiation hazard	Label
	Indicates the authorized representative in the European Community.	Label
	The CE symbol indicates that this product complies with the European Regulation for Medical Devices Regulation 2017/745 as a class IIb device.	Label
	UL mark No. E476672	Label
	Caution: Federal law restricts this device to sale by or on the order of a licensed healthcare practitioner.	Label

2. General Information

Symbols	Description	Location
	Addresses where the equipment was manufactured.	Label
	Indicates that electrical and electronic equipment must not be disposed of as unsorted municipal waste and must be collected separately.	Label
	Warns ESD hazard.	MCU board / Board package
	Indicates that this equipment is classified as a CLASS 1 LASER PRODUCT by IEC 60825-1 ED. 3 regulations.	Label
	Indicates that the user needs to refer to the user manual .	Label
	Indicates the date of manufacture.	Label
	Indicates the manufacturer's serial number to identify the specific equipment.	Label

3. Warnings and Precautions

3.1 General Safety Guidelines

Operator Qualifications

This equipment must be operated by a qualified person who is trained in proper operating procedures. To operate the equipment, the operator must meet the following standards:

- Read and understand the **user manual**.
- Understand this equipment's structure and function.
- Recognize problems in the equipment and implement appropriate solutions.

General Safety Precautions

- Follow the instructions in this manual to ensure the safety of both the patient and the operator.
- The operator must maintain vocal or visual communication with the patient while acquiring an image.
- Do not open or remove this equipment's cover. Only VATECH-approved technicians can inspect and repair this equipment.
- Do not place any heavy objects on this equipment under any condition.
- Do not place any objects within this equipment's field of operation. This may cause property damage.
- Install equipment with a wall bracket or other connecting parts. Both operators and patients can receive injuries from the equipment tip-over if it is not securely mounted to the wall or the floor.
- Instruct the patient to remain still until the equipment stops moving after the image acquisition.
- Observe all local fire regulations. Always keep a fire extinguisher near the equipment.
- The operator must be familiar with this equipment's emergency protocols.
- Keep the equipment away from water, moisture, or foreign substances. This equipment is an IPX0 device and is not intended to be used near liquids.
- Ensure that no liquid enters the equipment while acquiring an image of the patient under the following conditions:
 - Patients with a urinary catheter (drainage bag)

3. Warnings and Precautions

- Patients who have implants or underwent oral anesthesia or other procedure that can cause drooling during the image acquisition.
- When this equipment is exposed to water, moisture, or a foreign substance, turn off the equipment immediately and contact your **VATECH** technical support representative.
- When there is a sign of oil leakage, stop the equipment immediately and contact your **VATECH** technical support representative.
- The external parts connected to the outside of equipment such as cables must comply with relevant IEC Standards. (e.g., IEC 60950 for IT equipment and IEC 60601-1 series for medical electrical equipment).
- Likewise, these parts must comply with IEC 60601-1, IEC 60601-1-1, and the national regulations of the country where the equipment is installed. Please contact **VATECH** or its area representative if you have questions.
- Any person or organization that installs an external door interlock switch is responsible for ensuring that the switch has a radiation indicator or equivalent alarm system to show the state of the current.
- Any serious incident that has occurred in relation to the device should be reported to the manufacturer and the competent authority of the member state in which the user and/or patient is established.

Ventilation

- Do not block the equipment's ventilation slot. Blocking the slot may cause overheating and equipment malfunction.
- Do not spray a cleaning product into the ventilation slot. The air-sprayed liquid may damage the electrical and mechanical components inside. Use a soft cloth to disinfect the ventilation slot.
- Leave enough space around the PC system to avoid overheating.



Follow all warnings and safety instructions in this manual to guarantee a safe operation.



To work safely around the X-ray equipment, follow precautions and conduct regular inspections. Ignoring the precautions may endanger both patients and operators.

Hygiene

Turn off the equipment before you start cleaning.



Do not use a cleaner spray on the equipment. Spraying liquid directly over the equipment can cause a fire or damage the electrical parts inside the equipment.

- Clean the handle frame with a non-alcoholic product after the patient leaves the X-ray room.
- Clean the removable accessories that directly contact the patients, such as the bite blocks and temple support, with a non-alcoholic product.
- Clean the equipment's surface with a soft fabric dampened in a non-alcoholic cleaning product.
- Always provide a new sanitary vinyl cover for each patient to prevent transmissible diseases.



- When the sanitary vinyl covers provided by VATECH runs out of stock, contact the manufacturer.
- If you use sanitary vinyl covers from a 3rd party, ensure that the product conforms to one of the following standards:
 - ISO 10993-1 (Biological Evaluation of Medical Devices)
 - FDA
 - CE
 - Local regulations in your area

Condensation

- Condensation can occur inside the equipment when the temperature difference is great between the outside and inside of the X-ray shielding room, where the equipment is installed. To avoid condensation, store the equipment at room temperature.

Cooling

- Allow the X-ray tube to cool down before starting the next X-ray exposure. The continuous operation without a cooling time may cause an overload.
 - **Mode of operation:** non-continuous operation (NFPA 70: long time operation) - needs waiting time (at least 60 times the exposure time) before the next exposure begins.
 - **Column operation time:** Max. 2 min. On / 18 min. Off (Ratio 1:9)
- When the tube head's temperature rises to 60 °C (140 °F), the X-ray exposure stops, and an error message is displayed on the console window. The equipment restarts working after the tube head's temperature drops to 58 °C (136.4 °F).

Turning the Equipment On / Adjusting Equipment's Height

- Ensure that the patient does not stand near the equipment when the staff is turning on the system or adjusting the equipment's height to avoid injuries from the rotating unit or vertical frame's movement.

Stopping the Equipment in Emergency

- Press the **emergency stop switch** when you detect a problem with the equipment during the operation. The equipment will stop as you press the switch. The emergency stop switch is located under the handle frame. If the problem is resolved, turn the switch in the direction of the arrow to reboot the system.

Trouble-Free Operation

- Never use this equipment in an environment that is susceptible to explosion.
- Always operate the equipment within a temperature range of 10 °C to 35 °C (50 °F to 95 °F) for safe operation. Image quality may deteriorate when the equipment operates outside of this temperature range.
- Always allow the equipment enough time to warm up (while switched on) if exposed to temperatures below 10 °C (50 °F).
- Acquire an image of the patient only when the system is in a proper condition.
- Ensure that no person or object such as the patient's clothing stands in the way of the equipment.
- Do not leave the patient unattended around the equipment.
- Remove all radio-controlled devices and mobile phones from the X-ray room before image acquisition because these objects may cause trouble for the equipment.

Modifying the Equipment

- Modifying the equipment in any way which may affect the safety of the people is prohibited by law.
- Operators cannot replace or repair any parts of this equipment. Only a VATECH-approved technician has the right to inspect and repair this equipment.
- Always use accessories and parts for this equipment provided either by **VATECH** or a VATECH-approved 3rd party.

3.2 Electricity-Related Safety Precautions



To avoid the risk of electric shock, this equipment must only be connected to supply mains with protective earth.

- Check the status of the power source, PC, and cables before operating the equipment.
- Ensure that the **main power switch** is turned off when the equipment is not in use.
- Always disconnect the power supply before cleaning the equipment.
- Always keep electrical cords away from hot appliances or radiators.
- Do not place the PC or peripheral equipment connected to the PC near the patient.
- The equipment and PC should be connected to a common protective earth.
- Never overload the equipment's circuit by sharing it with too many appliances.
- PC must be used outside the patient environment such as the X-ray room.

Combining This Equipment with Other Devices

- Do not connect this equipment to devices that are not designated as a part of the system.
- Do not connect this equipment to a Multiple Portable Socket-Outlet (MPSO) or extension cord, which is not provided with the equipment.

Electromagnetic Compatibility

- This X-ray equipment complies with IEC standard 60601-1-2.
- Medical electrical equipment is subject to special Electromagnetic Compatibility (EMC) preventive measures. It must be installed and operated as specified in EMC information.
- If high-voltage, radio link, or MRI systems are located within 5 m of the unit, please observe the specifications stated in the installation requirements.
- Portable Radio Frequency (RF) communications equipment may interfere with medical electrical equipment. Therefore, mobile wireless phones in medical offices or hospital environments must be prohibited.
- For more details, refer to **16.4 Electromagnetic Compatibility (EMC) Information**.
- Please also observe the Electro-Static Discharge (ESD) protective measures described.

Static Discharge

- Without observing ESD protective measures, connector pins or sockets bearing ESD warning labels must not be touched or interconnected.



Electrostatic discharge (ESD)

ESD Protective Measures

- Procedures for preventing electrostatic charge build-up (e.g., temperature control, humidification, conductive floor coverings, and non-synthetic clothing)
- Electrostatic discharge of your own body with the frame of the equipment, the protective ground wire, or large metallic objects
- Use of the wristband for grounding

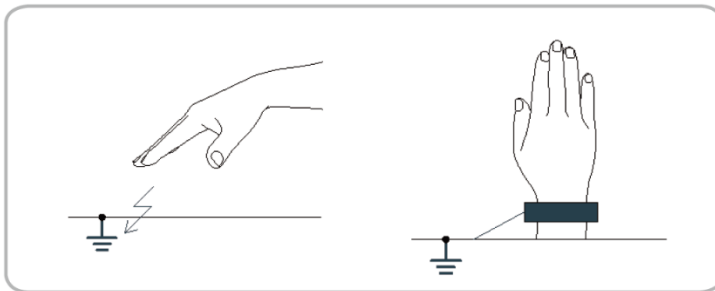

3.3 Radiation Safety

- Ensure to install this equipment inside an X-ray room.
- The operator must stay outside of the X-ray room while acquiring an X-ray image to protect himself or herself from radiation exposure.
- The operator must be able to communicate with his or her patient either visually or verbally while the equipment is in operation.
- Check the status of the patient and the equipment until the image acquisition is completed.
- Stay at least 2 m (7 ft) away from the equipment during the image acquisition.
- Stop the equipment immediately when a problem occurs during the image acquisition.
- Guide the patient to wear a lead apron with a neck collar before image acquisition for thyroid protection.
- Children and pregnant women must consult their doctors before X-ray scanning.
- Check if your patients have an electrical medical device implanted in their body or are currently under radioactive iodine seed treatment. Patients who meet one of these conditions must be informed before X-ray scanning about the danger associated with radiation exposure.
- Guide the following patients to consult their doctor before taking an X-ray:
 - 1) the patients with the implanted medical device.
 - 2) the patients under the radioactive iodine seed treatment.
- The implanted medical devices that require a doctor's consultation before X-ray scanning are insulin pumps, cardiac implantable electronic devices (pacemaker and implantable cardioverter defibrillators), and neurostimulators.







As a manufacturer of radiology equipment, **VATECH** guarantees the maximum degree of protection against radiation hazards for its product.



Because the radiation safety regulations differ across countries, both equipment owners and users are responsible for following radiation safety regulations and protective measures in their areas.

3.4 Warnings

Follow the warnings below to ensure your safety. Failure to follow these warnings can cause injuries or damage to the equipment.

 WARNING	<ul style="list-style-type: none"> ▪ X-ray equipment is hazardous to the patient and the operator if proper exposure safety measures and operating instructions are not observed. ▪ Read this user manual and follow all warnings and cautions in the manual.
 WARNING	<ul style="list-style-type: none"> ▪ Do not use 3D images for screening examination. ▪ Taking an X-ray is justified only when its benefits outweigh its risks. ▪ Use the medical CT or MRI to examine the patient's soft tissue, instead of the dental CT.
 WARNING	<ul style="list-style-type: none"> ▪ Green X 12 (Model: PHT-75CHS) uses high-frequency electrical signals like other medical devices, so it may interfere with implanted medical devices such as pacemakers or implantable cardioverter-defibrillators (ICDs). If a patient is using such an implanted medical device, please be aware of this and immediately turn off the device if interference occurs. ▪ If there is a concern about electromagnetic interference (EMI) with a patient's implanted medical device, please guide them to consult with the physician in charge of the implanted medical device.
 CAUTION	<p>Federal law restricts the sale of this device to dentists or the personnel licensed by the law of the state where he or she uses or orders the use of the device.</p>

Lasers

- The system incorporates Class 1 laser products. The light localizers used in this product are intended for correct patient positioning and must not be used for any other purpose.
- Advise the patient not to look directly at the laser beam for maximum safety.
- While adjusting the patient, ensure that the laser beam is not directed at the patient's eyes.
- Wavelength: 650 nm, Radiant power: Max. 039 mW.



Risk of Eye Injury!

- Do not use this equipment with any other laser sources.
- Do not make a change to the settings or process written in this manual.

Cleaning

- Never expose this equipment to liquids, mists, or sprays. Exposing this equipment to liquids may cause an electric shock or otherwise damage the system.
- Do not use spray cleaners on this equipment, as this could cause a fire.

During the Operation

- Never use this equipment in an environment that is susceptible to explosion.
- Do not place flammable materials near this equipment.
- Do not operate the PC while the equipment is operating. Failure to comply with this instruction may result in system malfunction.
- Immediately stop imaging if the equipment malfunctions in any way.
- If a problem occurs during imaging, press the **emergency stop switch** to immediately stop all moving parts and cut off all power to the equipment's electrical components.
- Never touch the patient while he or she is touching the SIP/SOP connectors.
- The medical electrical equipment or system should not be used adjacent to or stacked with other equipment. If adjacent or stacked use is necessary, the medical electrical equipment or medical electrical system should be observed to verify normal operation in the configuration in which it will be used.
- The use of accessories and cables other than those specified, except cables sold by **VATECH** of the medical electrical equipment or medical electrical system as replacement parts for internal components, may result in increased EMISSIONS or decreased IMMUNITY EQUIPMENT or SYSTEM.

In case of an electrical fire

- Ensure to use the fire extinguisher for electrical fire only. Using a fire extinguisher that uses water, foam, or other wet chemicals can damage the equipment and cause electrical shock or burns.

Installation

- To avoid improperly balanced equipment, install the device on a flat surface to maintain stability.
- If the equipment is not stable, property damage and personal injury may occur.
- Do not push or pull the equipment.
- An authorized technician should only install equipment, complying with proper installation procedures.

NOTICE

For more information about installing the equipment, read the **Green X 12** installation manual.

Security Capabilities

- It is recommended to install and operate **EzDent-i** SW within a secure operating environment that allows only authorized users to access a system network equipped with Windows built-in firewall, Windows Defender antispyware tools, and other commonly used 3rd party security tools and application systems.
- The latest updates for anti-virus software and a firewall are recommended.
- The software can be updated by the manufacturer only. Unauthorized software update through a third party, not the manufacturer, is prohibited. Please contact the manufacturer for cybersecurity issues related to the software and medical devices.

3.4.1 Side Effects

- X-ray imaging exams should be performed only after careful consideration of the patient's health needs. The operator must understand the well-known risks which can occur during the X-ray exposure and minimize them by preventing unnecessary radiation exposure for patients.

4. Imaging System Overview

4.1 System Components

- **Green X 12 (Model: PHT-75CHS)** X-ray equipment
- PC system
- Console Software: PANO, CEPH (Optional), CBCT, and 3D MODEL Scan
- **EzDent-i:** 2D viewer and patient management software
- **Ez3D-i:** 3D viewer software

4.2 Features

- **Smart Focus:** a CBCT capture mode that first captures a 12x8.5 image, then reconstructs the image into multiple 4x4 high-resolution images after the user selects the areas for reconstruction out of the first captured image. The user can select up to three areas for image reconstruction.
- **Double Scan:** a CBCT capture mode that scans the mandible and maxilla and reconstructs their images into a single 12x14 image.
- **Endo:** a CBCT capture mode specialized for root canal treatment. This mode captures a single tooth that the user selects and provides a high-resolution 4x4 image that reveals the detailed structure within the selected tooth such as blood vessels and nerves.
- **Insight PAN:** a PANO capture mode. This mode only captures the area that the user chooses and reconstructs it into multiple 2D images with multiple focal points. The mode minimizes radiation exposure and allows the user to access the areas that cannot be detected by a conventional 2D panoramic image.
- **Magic PAN:** a PANO image reconstruction algorithm that minimizes the differences between the real arch shape and the reconstructed image. It provides an optimized panorama image of the arch regardless of its shape.
- **Auto Pano (the option in the Smart Focus, Double Scan, and 12x8.5 mode):** this option provides a 2D panorama image of the patient's arch when taking an image for the Smart Focus, Double Scan, and the 12x8.5 mode.
- **Full Arch (the option in the Smart Focus mode):** this option provides a 12x8.5 high-resolution image of the patient's full arch when taking an image for the Smart Focus mode.
- **Scout Capture (the option for the 8x5 and the Endo mode):** this option allows a more precise selection for a capture area with a 2D preview before taking an 8x5 and Endo image.

- MAR (Metal Artifact Reduction)
- DICOM (Digital Imaging and Communications in Medicine) Format
- Various FOVs: 12x14 (Double Scan), 12x8.5, 8x8, 8x5, 4x4.
- Easy-to-use and intuitive console software.

4.3 Imaging System Options

Configuration	Item	Sensor	
SP	PANO +CBCT	PANO / CBCT	Xmaru1404CF-Plus
RC	PANO +CBCT +CEPH	PANO / CBCT	Xmaru1404CF-Plus
		CEPH	Xmaru2602CF

4.4 Operating Principles

X-ray is emitted when a high voltage is supplied to the X-ray tube assembly, which frees electrons from the cathode.

They hit an anode to produce an X-ray. The machine acquires images by emitting X-rays continuously and rotates on the human tooth at different angles.



Images are acquired, computed, and recompiled to reproduce 2D or 3D images.

4.5 Standards and Regulations

Standards

Green X 12 (Model: PHT-75CHS) is designed and developed to comply with the following international standards and regulations:

- MEDICAL - APPLIED ELECTROMAGNETIC RADIATION EQUIPMENT AS TO ELECTRICAL SHOCK, FIRE, AND MECHANICAL HAZARDS ONLY IN ACCORDANCE WITH ANSI/AAMI ES60601-1 (2005) + AMD 1 (2012), CAN/CSA-C22.2 No. 60601-1 (2014), IEC 60601-1-3:2008, AMD1:2013, IEC 60601-2-63:2012, AMD1:2017, AMD2:2021
- 21 CFR 1020.30, 31, 33
- NEMA Standard publication PS 3.1-3.18

	<p>This is class IIb equipment and obtained CE marking in May 2017 for regulation compliance by the enacted European Union's MDR (Medical Device Regulation)</p>
	<p>MEDICAL - APPLIED ELECTROMAGNETIC RADIATION EQUIPMENT AS TO ELECTRICAL SHOCK, FIRE, AND MECHANICAL HAZARDS ONLY IN ACCORDANCE WITH ANSI/AAMI ES60601-1 (2005) + AMD 1 (2012), CAN/CSA-C22.2 No. 60601-1 (2014), IEC 60601-1-3:2008, AMD1:2013, IEC 60601-2-63:2012, AMD1:2017, AMD2:2021.</p>

Classifications (IEC 60601-1 6.1)

- The degree of protection against water ingress: Ordinary Equipment: IPX0
- The degree of protection against electric shock: Class 1 equipment, Type B applied parts (chinrest, bite and cover, nasal positioner and cover, ear rod and cap, carpus plate).



4.6 Imaging System Configuration

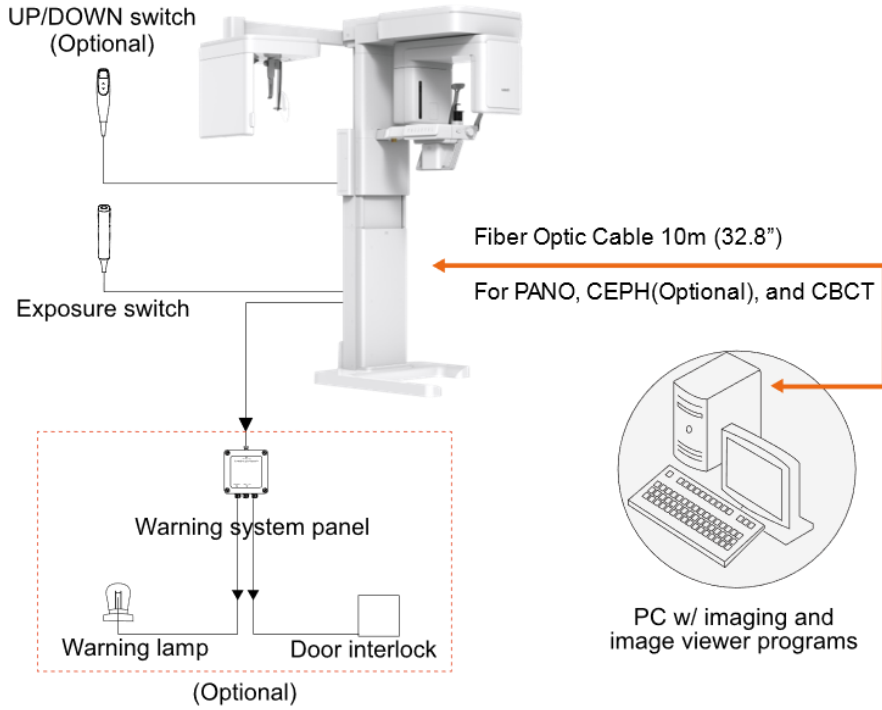

IMPORTANT

Ensure to use the PC outside of the patient environment such as X-ray (Radiology room).

PC Signal Input/Output

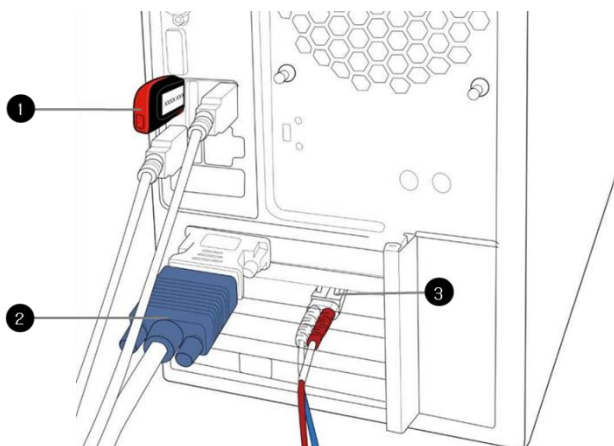

No.	Item
1	3D viewer License Key
2	Video output
3	Fiber optic cable (Data in/out: UART communication)

Ports and Cable Connections

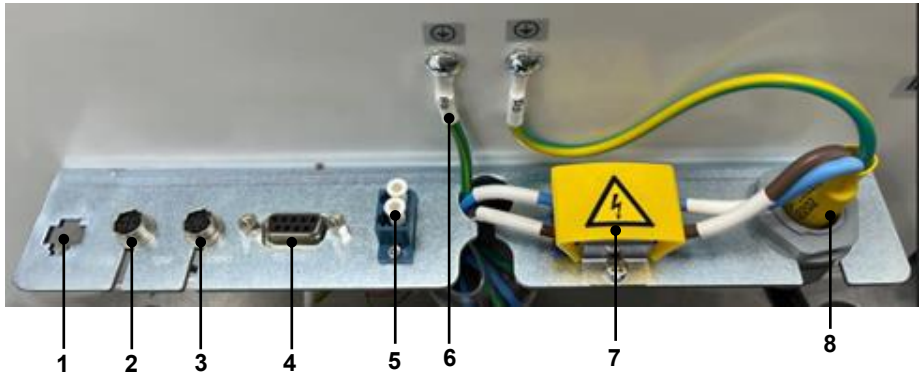

No.	Item	Description
1	Emergency Stop Switch Port*	Connects the emergency stop switch to the equipment.
2	Door Lock Port	Connects the door lock cable to the equipment when installing a door lock.
3	Exposure Switch Port	Connects the exposure switch to the equipment.
4	RS232 Port	Used for testing and repairing equipment.
5	Optic Port	Connects the main MCU and the sensor with the PC.
6	Frame Ground Cable	Connects the external FG with the internal FG.
7	Terminal	Connects the external power cable with the internal power cable.
8	Power Cable	Supplies the power to the equipment.

*Emergency stop switch port is used in Russia only.

4.7 Equipment Overview

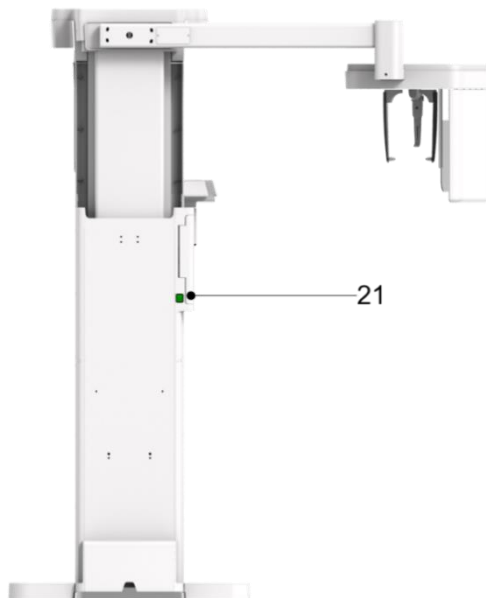
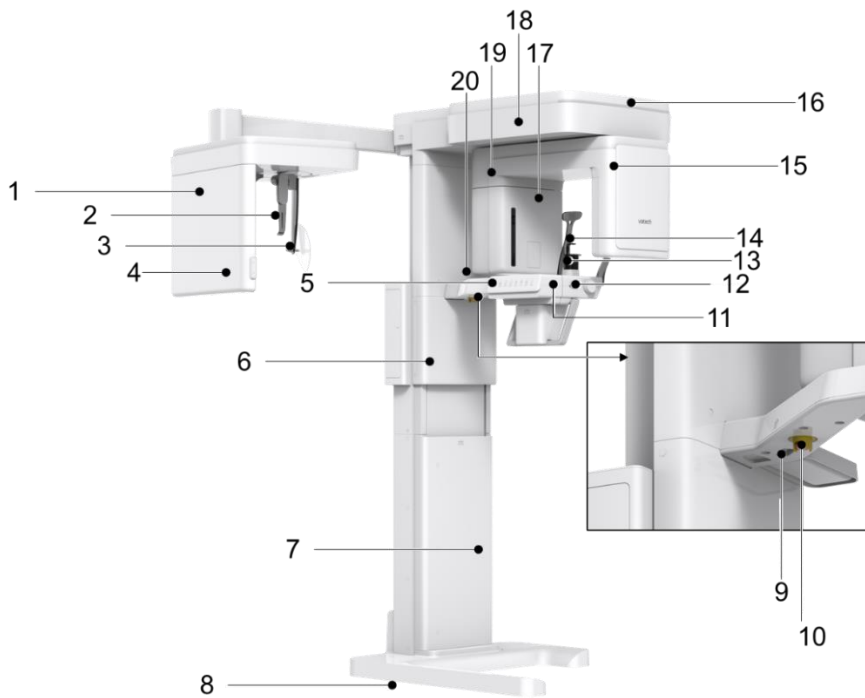

No.	Item	Description
1	X-ray Detector for CEPH (Optional)	Xmaru2602CF for CEPH imaging sensor.
2	Nasal Positioner	Corrects the patient's position for the CEPH imaging procedure.
3	Ear Rods	Secures the patient's head during CEPH imaging.
4	Column up /down button (embedded on the CEPH unit)	Adjusts the column's height
5	Control Panel	Controls the laser beam, the rotating unit, and the column's height. For more information, go to 4.7.1 Control Panel .
6	Column Up /Down switch (Optional)	Adjusts the column's height
7	Column	Supports the whole part of the equipment.
8	Base (Optional)	Balances the equipment and maintains its safety.
9	D-Sub Connector	Serves as the input signal port for the column up/down switch.
10	Emergency Stop Switch	Stops the equipment in an emergency. For more information, go to 4.7.2 Emergency Stop Switch .
11	Canine Teeth Beam Lever	Changes the canine beam's location to align the beam with the patient's Frankfurt line(plane).
12	Temple Supports OPEN/CLOSE Knob	Opens or closes the temple supports.

4. Imaging System Overview

No.	Item	Description
13	Chinrest	Places the patient's chin for the imaging procedure.
14	Temple Supports	Holds the patient's head in position for PANO and CBCT imaging.
15	X-ray Detector for PANO/CBCT	Xmaru1404CF-Plus for PANO and CBCT imaging sensor.
16	LED Lamp	Indicates the X-ray exposure status. <ul style="list-style-type: none">▪ Green: X-ray is on standby▪ Yellow: X-ray is on
17	X-ray Generator	The X-ray tube where the X-ray is produced.
18	Vertical Frame	Holds the rotating units
19	Rotating Unit	Rotates around the patient's head to acquire an X-ray image.
20	Enclosed Component Storage	Stores enclosed components such as bites, chinrest, and other accessories.
21	Main Power Switch	Turns on or off the equipment.

4.7.1 Control Panel

You can do the following tasks on the control panel:

- Adjusting the column's height
- Adjusting the chinrest's height (for CBCT mode only)
- Turning on or off the laser beams.
- Adjusting the horizontal beam's location (for PANO mode only)
- Changing the rotating unit's position for image acquisition

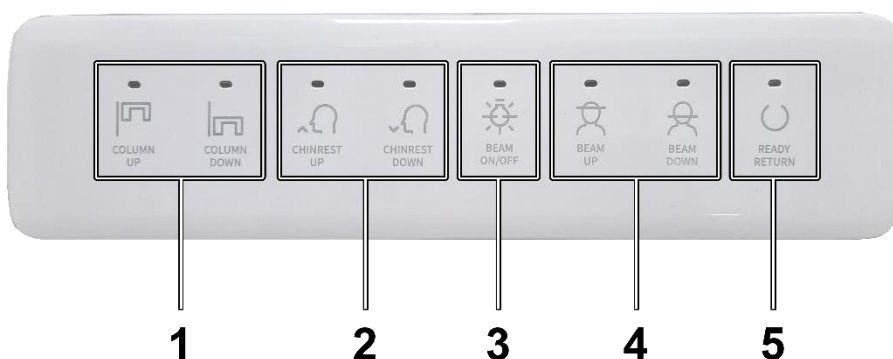

No.	Buttons	Description
1	Column Up / Down	Adjusts the column's height by moving the moving column up and down.
2	Chinrest Up / Down	Adjusts the chinrest's height for the CBCT imaging.
3	Beam On / Off	Turns on or off the laser beams for patient positioning.
4	Beam Up / Down	Adjusts the horizontal beam's location for panoramic imaging.
5	Ready / Return	Indicates that the X-ray is ready for exposure with the LED. Moves the rotating unit's position to its initial place.

4.7.2 Emergency Stop Switch

The emergency stop switch is located under the handle frame. Press the switch to stop the equipment in an emergency. The emergency may include the following situation but is not limited to:

- When the X-ray emission continues after releasing the exposure switch
- When the equipment hits the patient, a mechanical failure occurs.

To restart the equipment after the situation is resolved, turn the switch until it pops up again.



4.7.3 Exposure Switch

The **exposure switch** allows the operator to control image acquisition from outside of the X-ray room.







Press and hold the **exposure switch** down until the acquisition is completed. Premature release of the **exposure switch** will abort image acquisition.

Pressing the exposure switch activates the LED indicator to turn yellow. This color indicates that the X-ray is being emitted.



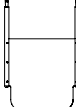

IMPORTANT	Ensure the exposure switch cable is not detached from the equipment during the operation.
IMPORTANT	Keep vocal/visual contact with the patient during exposure. In an emergency, release the exposure switch immediately.

4.7.4 Accessories

The following accessories are used to position the patient and support the equipment. The accessories that have contact with the patient must be disinfected between each patient. For more information about cleaning accessories, go to **Chapter 12. Cleaning and Disinfection**.

Accessory	Descriptions	Materials
	Normal Bite - used for the PANO (normal) and CBCT scan. - used for non-edentulous patients.	PC (Polycarbonate)
	Special Bite A - used for both edentulous and non-edentulous patients. - used for both TMJ and sinus scanning.	PC (Polycarbonate)
	Special Bite B - used for the PANO (normal) and CBCT scan. - used for edentulous patients.	PC (Polycarbonate)
	Chinrest - used for all imaging modes except the CEPH mode.	ABS (Acrylonitrile butadiene styrene) copolymer
	Temple Supports (1 set)	Temple Supports: PA(Polyamide) Temple Support Pad: Silicone
	Ear Rods (1 set)	Silicone
	Nasal Positioner Cover - For CEPH	Silicone
	Carpus Plate	PC (Polycarbonate)

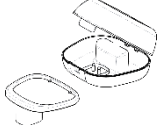
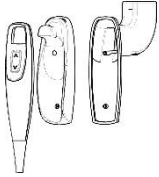
4. Imaging System Overview

Accessory	Descriptions	Materials
	Sanitary Vinyl Covers (disposable) for the Bite	PP+PE
	Protractor (1 set) - For positioning the patient's body in CEPH mode.	PC (Polycarbonate)
	Model Scan Jig	ABS (Acrylonitrile butadiene styrene) copolymer
	Up/Down Switch and Holder	ABS (Acrylonitrile butadiene styrene) copolymer
	Wall Bracket	SPCC

This Page Intentionally Left Blank

5. Imaging Software Overview

Three programs are included in this equipment to acquire, process, and view the image:

- **EzDent-i** 2D viewer and patient management software
- **Ez3D-i** 3D viewer software
- Console software: PANO, CEPH (Optional), CBCT, and 3D MODEL Scan

5.1 PC Specifications (Recommended)

Item	Specifications
CPU	Intel XeonW-2223 3.6 4C
RAM	32GB(4x8 GB) DDR4-2666 ECC REG APJ or Larger
HDD	1TB SATA 7200 rpm * 2EA
Graphics board	RTX 3050 D6 8GB
Ethernet Interface	Broadcom 5761 Gigabit PCIe NIC
Serial Port (RS232)	HP Serial Port Adapter Kit
Power Supply	750 W internal power module, up to 90% efficiency, active PFC
Slots	2 ports PCIe 3 x4 2 ports M.2 PCIe 3 x4 1 port PCIe x8 2 ports PCIe x16 1 PCI Slot
CD/DVD drive	DVD-ROM, DVD+/-RW, Blu-Ray
Monitor	19" 1280x1024 screen resolution
Operating System	Windows 10 or Higher
Recommended System	HP Z4

5.2 EzDent-i

EzDent-i is imaging software that manages the acquired images for faster and more accurate diagnoses. The software is linked with the console software and the 3D viewer, allowing user to save the acquired images and view them in three dimensional.

NOTICE

To use EzDent-i, please read the EzDent-i user manual.

NOTICE

Security Capabilities

- Ensure to install and operate **EzDent-i** under a secure environment where only authorized users can access the system network with defender antispyware tools and a built-in firewall.
- Ensure to use the latest anti-virus software and firewall. Update them regularly for cyber security.
- A cover is installed on the back of the equipment to prevent unwarranted persons from accessing the communication port. Do not remove the back cover unless you are an authorized VATECH technician.
- Contact VATECH for inquiries about the cyber security issues of the equipment and its software.

5.3 Console Software

The user selects a capture mode and exposure settings on the console software. The below shows the console software's home window.

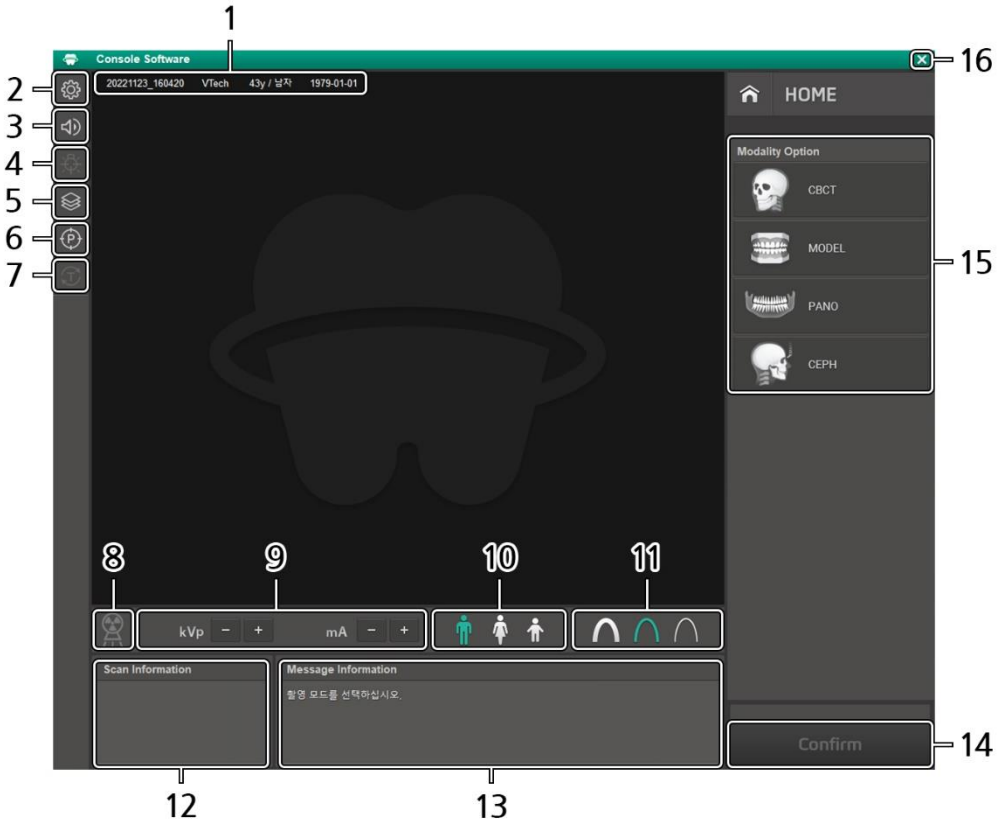

Console Software HOME Window

NOTICE

The console software's UI and features can be updated without notice due to product enhancement.

No.	Item	Description
1	Patient information	Displays the selected patient's information.
2	Setting button	Sets user environments for the console software and capture modes such as auto-save option or language.
3	Volume button	Changes audio message's volume level.
4	Laser on/off button	Turns on or off the laser beams.
5	Manual reconstruction button	Reconstructs the captured image after the system fails automatic reconstruction. How to Start a Manual Reconstruction <ol style="list-style-type: none"> 1) Click the manual reconstruction button. 2) Select a modality. 3) Click Search. 4) Select an image for reconstruction. 5) Click the button again.
6	Phantom Button	Captures a phantom image. How to Capture a Phantom Image <ol style="list-style-type: none"> 1) Click the phantom button. 2) Select a modality and click Capture. 3) Set exposure parameters and place a phantom jig. 4) Click Ready. 5) Press the exposure switch.
7	Test Rotation Button	Performs a test rotation to check before scanning if the equipment hits the patient. How to Start a Test Rotation: <ol style="list-style-type: none"> 1) To start a test rotation: 2) Ask the patient to enter the unit. 3) Select a modality. 4) Click Confirm. 5) Click the test rotation button. After clicking, the button turns green. 
8	X-ray exposure indicator	Indicates the X-ray exposure status. <ul style="list-style-type: none"> ▪ Gray: X-ray is off ▪ Yellow: X-ray is on
9	Exposure condition menu	Select exposure conditions (tube current and voltage).

No.	Item	Description
10	Patient selection menu	Selects or changes a patient type.
11	X-ray level selection menu	Selects or changes an X-ray level intensity.
12	Scan information window	Displays the estimated DAP(Dose Area Product), scan, and exposure times for the exposure settings you selected.
13	Message information window	Displays text guides for the user at each stage of operation.
14	Confirm (Ready) button	<p>This button performs a dual role.</p> <ul style="list-style-type: none"> ▪ Confirm: finalizes the capture mode and settings you selected. ▪ Ready: Prepares the equipment ready for X-ray exposure. The Ready button appears after the user clicks the Confirm button.
15	Modality Option	Selects a capture mode: PANO, CEPH (Optional), CBCT, and Model.
16	Exit button	Leaves the console window.

6. Getting Started

6.1 Turning on the Equipment

**WARNING**

Do not turn on the equipment when people stand near the equipment.

Follow the steps below to turn on the equipment.

1. Press the main power switch behind the column.

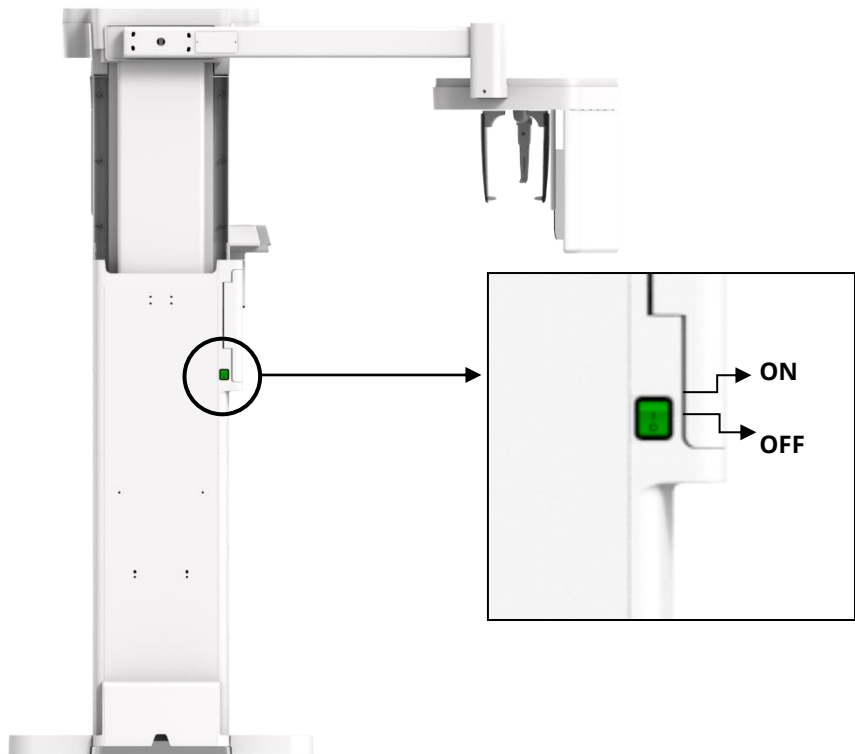

2. Check if a green light comes to the LED on the vertical unit.

6.2 Running the Image Viewer (EzDent-i)

NOTICE

Read the EzDent-i User Manual to learn how to use the image viewer. This manual is provided separately from the Green X 12 user manual.

NOTICE

Green X12's 3D viewer(Ez3D-i) and console software must be accessed through the 2D viewer (EzDent-i). 3D viewer and console software do not have storage to save captured images and the patient's information.

NOTICE**Security Capabilities**

- Ensure to install and operate EzDent-i under a secure environment that only authorized users can access the system network.
- The system network for EzDent-i must be protected with a Windows firewall, defender antivirus, and other programs commonly recognized for cyber security.
- Update antivirus software and firewall to maintain the latest version.
- The security cover is installed on the back of the equipment. Do not remove or open this cover unless you are a VATECH-authorized engineer.
- VATECH must update all software provided by VATECH.
- For inquiries about cyber security issues for VATECH's equipment and software, contact your nearest VATECH representative.

6.2.1 Creating a New Patient Information

Follow the steps below to create a new patient record on the **EzDent-i**

1. Double-click the EzDent-i icon. The main window pops up after clicking the icon.

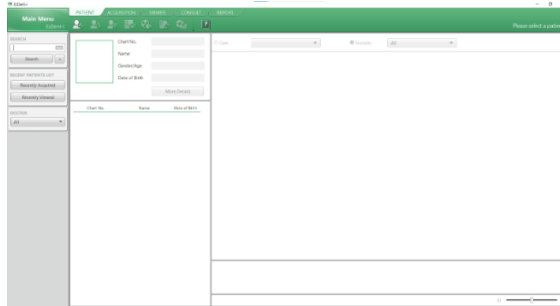

2. Click . After clicking the button, a dialog box appears as below.

The 'ADD PATIENT' dialog box is shown with the following fields and values:

- Chart No.*: 202191029_103203
- Last Name: Koo
- First Name: Hyunjun
- Gender: Male
- Date of Birth: Year (1974), Month (8), Day (15)
- Doctor 1: None
- Doctor 2: None
- Social ID: (empty)
- Phone: (empty)
- Mobile: (empty)
- E-Mail: (empty)
- Zip Code: (empty)
- Address: (empty)

Buttons: Add, Cancel

3. Enter **Chart No.** and **Name** on the dialog box. You cannot move to the next step without entering both.
4. Click  to save the new patient record.

6.2.2 Retrieving Existing Patient Information

Follow the steps below to retrieve the existing patient records.

1. Enter the **patient's name** or **chart number** in the search box.

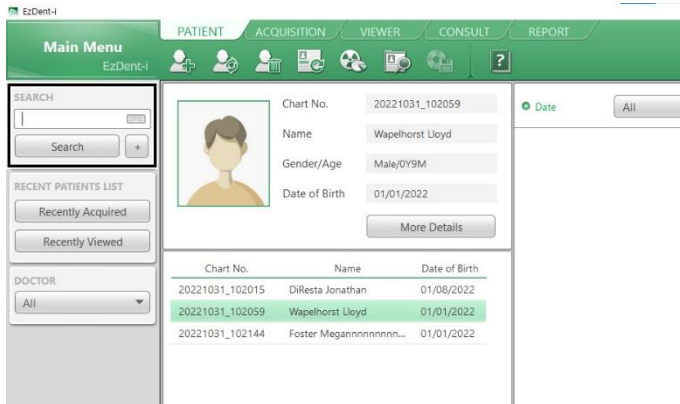

If necessary, click the keyboard icon next to the search field to use the virtual keyboard.

NOTICE

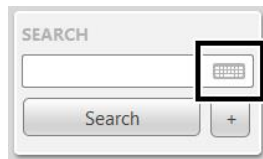

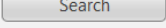
2. Click .
3. Double-click the patient record you want to retrieve.

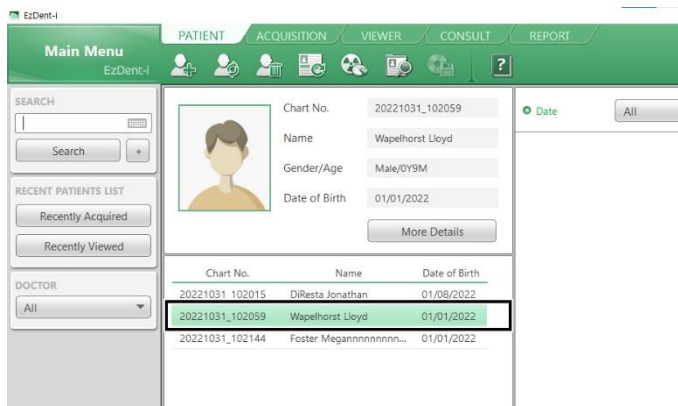

6.2.3 Starting Console Software

Follow the steps below to start the console software after retrieving (creating) the patient record.

IMPORTANT

Before starting the console software, ensure to create or retrieve the patient record.

1. Select the **ACQUISITION** tab.

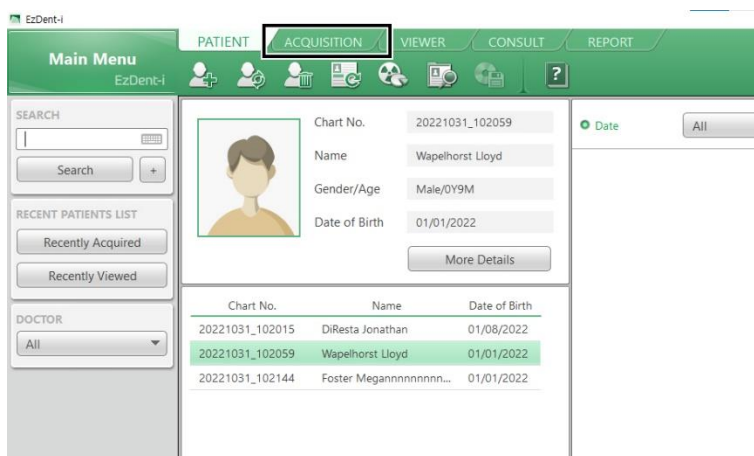

2. The capture mode menu appears below the search box. Select the capture mode you want to take an image with.

NOTICE

The menus on the window can be different according to the option that your equipment has.

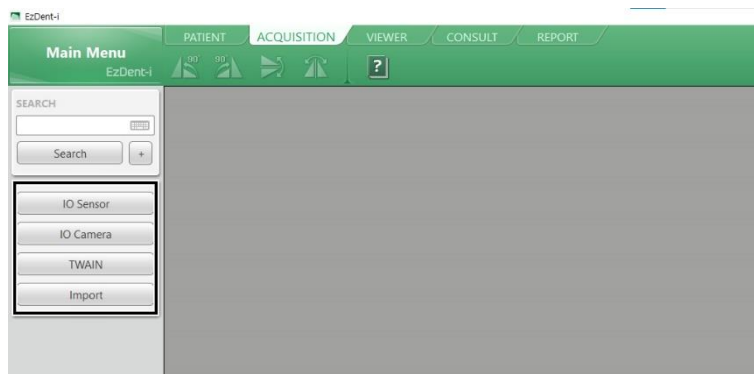

This Page Intentionally Left Blank

7. How to Acquire PANO Images

7.1 Program Overview

- **Role**







It provides 2D panoramic images.

- **Image Acquisition Method**

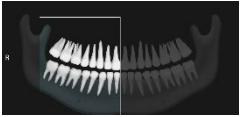

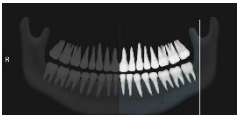



It reconstructs U-shaped arch data to a single 2D image utilizing multiple images taken with the X-ray beam scanning specific oral & maxillofacial regions at different angles.





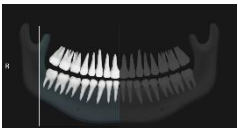
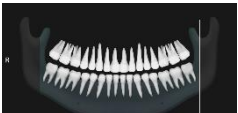
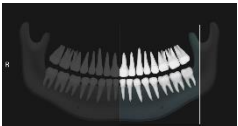
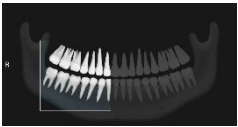

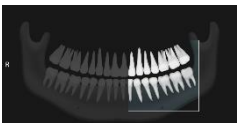
- **Examination Programs**

Programs are classified according to the ROI (Region of Interest).

Menu Tab	Arch Selection	ROI	Example
Normal	Narrow Normal Wide Orthogonal	Right	
		Front	
		Left	
		Standard	
	Child	Right	
		Front	

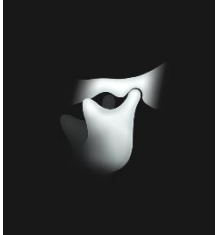
7. How to Acquire PANO Images

Menu Tab	Arch Selection	ROI	Example
Normal	Child	Left	
		Standard	
	Orthogonal	Right	
		Front	
		Left	
		Bitewing Right*	
		Standard	
		Bitewing Left*	
		Bitewings*	
		Normal	Orthogonal





Menu Tab	Arch Selection	ROI	Example
Insight PAN	Normal	-	
	Child	-	
Special	N/A	TMJ LAT Open	
		TMJ LAT Close	
		TMJ PA Open (Optional)	
		TMJ PA Close (Optional)	
		Sinus LAT (Optional)	

Menu Tab	Arch Selection	ROI	Example
		Sinus PA	

NOTICE



- The bitewing option is activated when you select 'Orthogonal' on the arch selection menu.
- Once the Insight PAN is selected, the user can freely choose the area for an X-ray exposure before the image acquisition.

■ Main Imaging Programs

Menu Tab	Arch Selection	ROI	Description & Sample Image
Normal	Narrow	Standard	<p>A panoramic imaging mode for patients with a V-shaped arch trajectory. (Typically for some females)</p> 
	Normal	Standard	<p>A panoramic imaging mode for adult patients with a typical arch trajectory.</p> 
	Wide	Standard	<p>A panoramic imaging mode for the patients with a square-shaped arch trajectory. (Typically for some males)</p> 
	Child	Standard	<p>A panoramic imaging mode for child trajectory. (Less X-ray exposure than the Normal mode by more than 40%)</p> 
	Orthogonal	Standard	<p>A panoramic imaging mode to minimize the overlapped region of the teeth from the X-ray exposure, which is beamed perpendicularly between teeth.</p> 

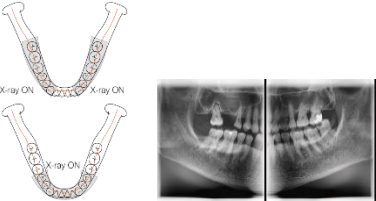
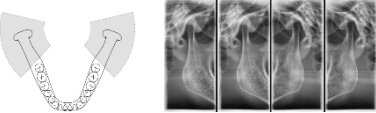
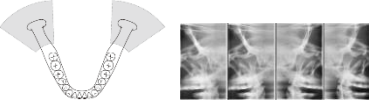
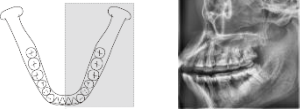
7. How to Acquire PANO Images

Menu Tab	Arch Selection	ROI	Description & Sample Image
		<p>Bitewings** (Bitewing Incisor mode is Optional)</p>	<p>A panoramic imaging mode to acquire an image only for the region of interest through the orthogonal trajectory. (Pros: less X-ray exposure than the Normal mode. /Cons: TMJ and some parts of the maxillary sinus cannot be acquired.)</p> 
Special	N/A	<p>TMJ LAT Open/Close</p>	<p>An imaging mode to acquire a lateral image of the TMJ, in which the X-ray beam is directed on the lateral TMJ region. (TMJ Open and Close)</p> 
		<p>TMJ PA Open/Close (Optional)</p>	<p>An imaging mode is to acquire a TMJ image, in which the X-ray beam is directed on the frontal TMJ, with the patient's mouth open fully and closed.</p> 
		<p>Sinus LAT (Optional)</p>	<p>A special imaging mode to acquire a Sinus image, in which an X-ray beam is directed on the lateral region of the maxillary sinus.</p> 

Menu Tab	Arch Selection	ROI	Description & Sample Image
		Sinus PA	<p data-bbox="827 314 1195 436">A special imaging mode to acquire a Sinus image, in which an X-ray beam is directed at the frontal region of the maxillary sinus.</p>  

7.2 Preparing X-ray System

Follow the steps below to prepare an image capture.

1. Clean accessories that have direct contact with patients. Go to **12. Cleaning and Disinfection** for the cleaning procedure.





Chinrest, bite blocks, and other accessories that have direct contact with the patients must be cleaned before scanning with chlorine dioxide-based alcohol-free products.

2. Insert a bite block into the chinrest. Ensure to select the bite block suitable for your purpose.

Bite Block	Purpose
Normal Bite	For the normal mode and non-edentulous patients.
Special Bite B	For the normal mode and edentulous patients.
Special Bite A	For the special mode (TMJ and Sinus). This bite block is used for both edentulous and non-edentulous patients.

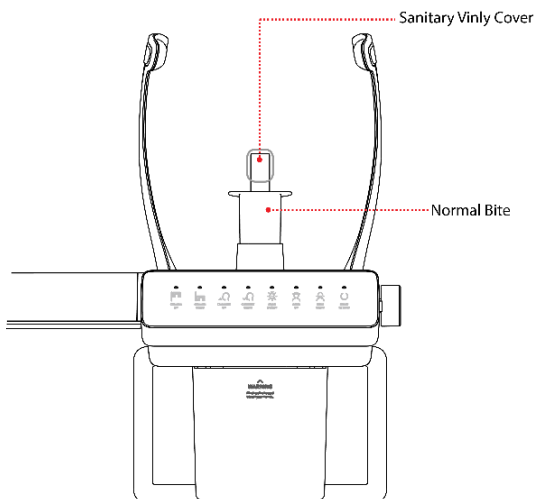
3. Insert left and right temple supports.
4. Put a sanitary vinyl cover on the bite block. Always change the cover after each scanning.



 CAUTION	We highly recommend using the sanitary vinyl cover provided by VATECH. When you run out of stock, contact the manufacturer.
 CAUTION	<p>If you are using a sanitary vinyl cover from 3rd party. Ensure that your product complies with one of the following standards:</p> <ul style="list-style-type: none"> ▪ ISO 10993-1(Biological evaluation of medical devices) ▪ FDA ▪ CE ▪ Local regulations in your area

5. Go to **7.3 Selecting Exposure Settings**.

7.3 Selecting Exposure Settings

For the PANO mode, you must select either the **normal** or **special** tab on the console software before selecting exposure settings. Follow the steps below to select a tab.

1. Open the EzDent-i window and select the **ACQUISITION** tab.

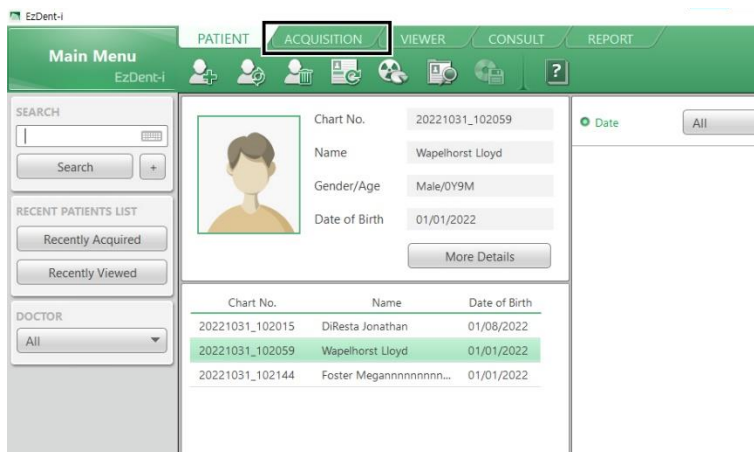

2. Select PANO from the capture mode menu. The PANO console window will appear after the selection.

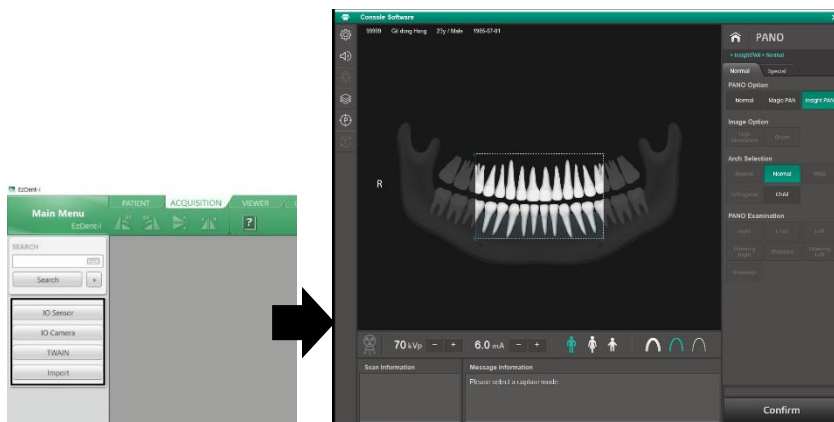

3. Select the **Normal** or **Special** tab according to the image you want to capture.
 - To capture a normal panoramic or Insight PAN image: select the Normal tab.

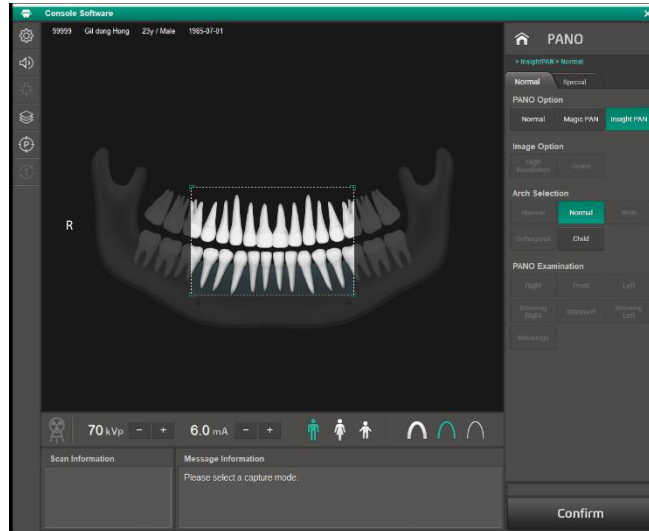

<Normal Tab Window>

- To capture a Sinus or TMJ image: select the **Special** tab.

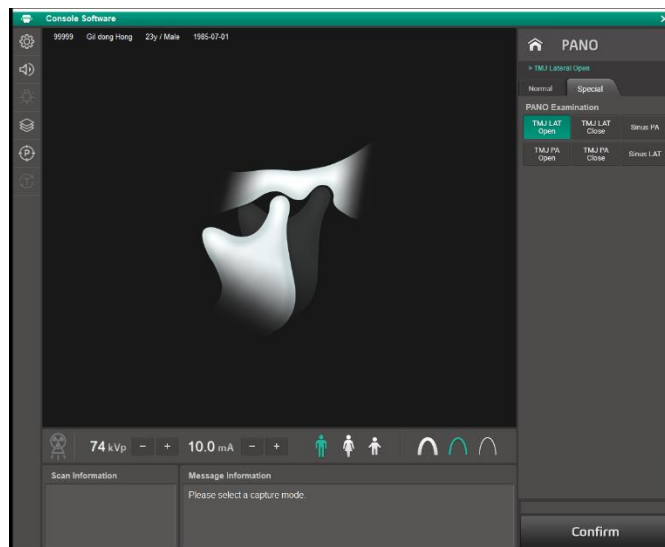

<Special Tab Window>

7.3.1 Normal Mode

Follow the steps below to select exposure settings for the Normal mode (normal panoramic image).

NOTICE

Magic PAN is an image reconstruction algorithm, not a scan option. For this reason, selecting Magic PAN does not change the options and the menu on the console software.

1. Select **Normal** from the PANO Option.

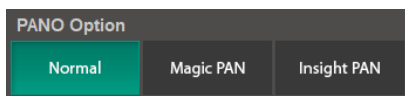

2. Select an Images Option.

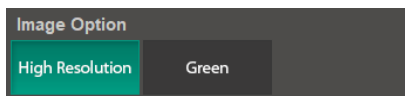

Mode	Description
High Resolution	High-Resolution image
Green	Normal-Resolution image

3. Select an arch type.

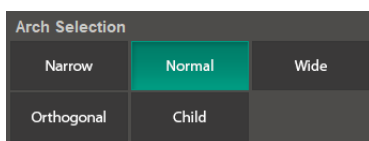

4. Select a PANO examination option.

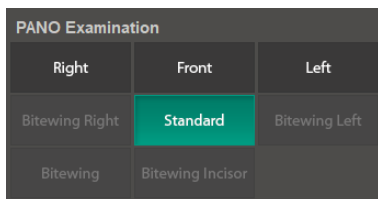

NOTICE

Select **Orthogonal** from the menu to enable bitewing options such as Bitewing Left.

NOTICE

To select the **Bitewing Incisor** option, go to the settings and enable the option from the segment mode option menu.

5. Select a patient type.



Man Women Child

Patient	VATECH standard
Man	Males over the age of 12
Woman	Females over the age of 12
Child	Males or Females under the age of 12

6. Select an X-ray intensity level.



Hard Normal Soft

Category	Average head circumference (cm)	Range (cm)	Intensity level
Child (Age 12 or under)	53±3	>53±3	Hard
		53±3	Normal
		<53±3	Soft
Adult (Above Age 12)	56±3	>56±3	Hard
		56±3	Normal
		<56±3	Soft

7. How to Acquire PANO Images

- Once the X-ray intensity level is selected, the system automatically sets the exposure condition. To change the condition, click the **plus-minus button** next to the voltage and the current symbols.



Each time you click the button, the voltage value changes by ± 1.0 kVp, and the current value by ± 1.0 mA.

The table below shows the range of exposure conditions that you can adjust.

Mode	Minimum Value		Maximum Value	
	kVp	mA	kVp	kVp
PANO	60	4	90	14

- Click **Confirm**. Once clicked you cannot change the selected settings and the system operates as below:



- The equipment moves to the image position.
- Laser beams are turned on.
- The progress bar appears above the Confirm button.
- The scan information window shows the estimated DAP (Dose Area Product), scan time, and exposure time.

NOTICE

When the progress bar reaches 100%, the **Confirm** button turns into the **Ready** button.

- Guide the patient to the X-ray room when you see the message below.

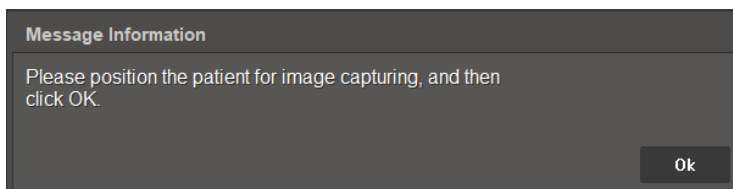

7.3.2 Insight PAN Mode

NOTICE

Insight PAN allows users to capture an image of the user-selected area only. By capturing a specific area, this mode minimizes the amount of radiation that the patient is exposed to.

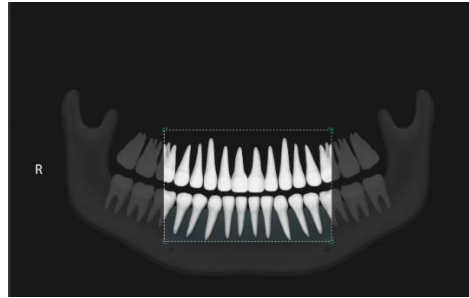

< Image Capture Area Selection window >

NOTICE



<Insight PAN image>

- When you want to capture a single tooth only, ensure to select the teeth left and right in addition, to the teeth you chose because each patient's arch is different.
- The minimum size of the areas that you capture with the Insight PAN is 50 x 50 mm².
- You can view the captured image with the Insight PAN, using Insight NAVI. connected to EzDent-i
- Read the EzDent-i user manual to learn more information about the Insight PAN.

7. How to Acquire PANO Images

Follow the steps below to select exposure settings for the Insight PAN mode.

1. Select **Insight PAN** from the PANO Option.

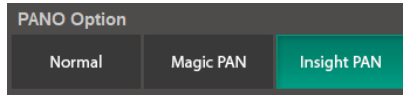

In the Insight PAN mode, some menus such as Image Option are disabled:

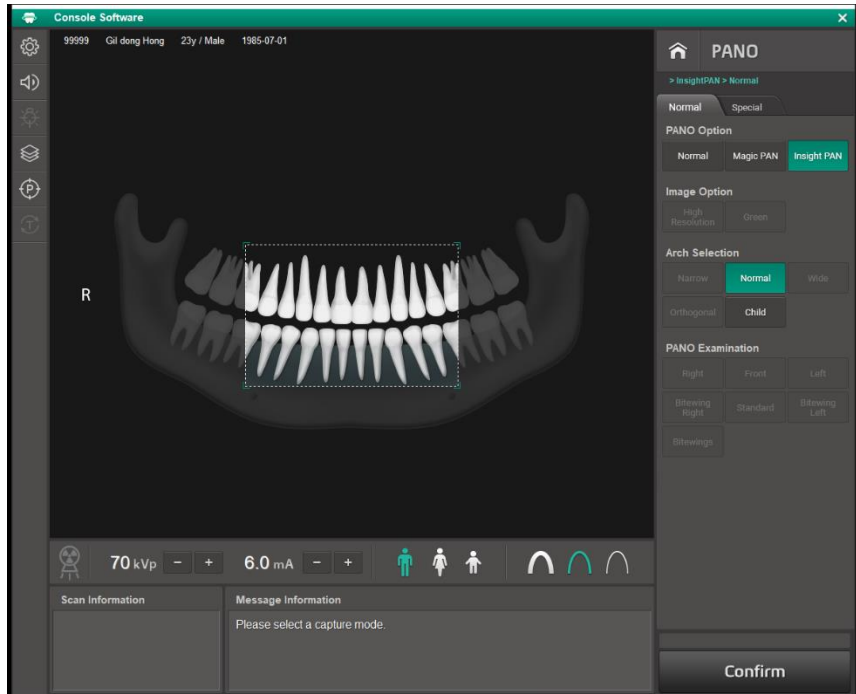

2. Select an area to capture. Insight PAN captures the area inside the crop box. Use the crop handles at the four corners of the box to move or resize the box.

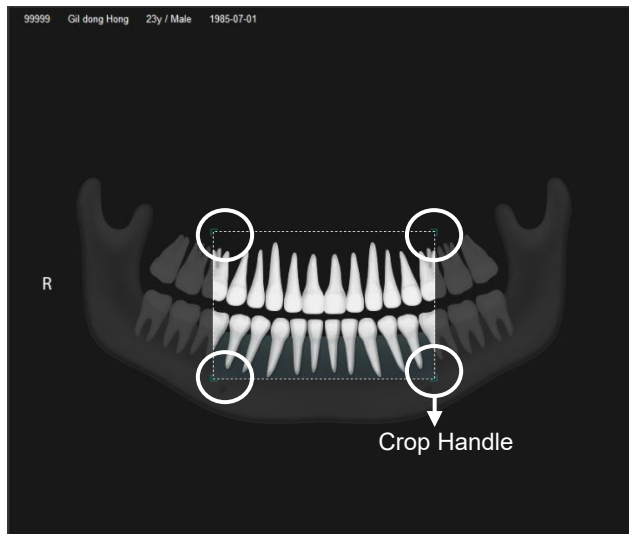

3. Select an arch type. For Insight PAN, you can choose either Normal or Child.

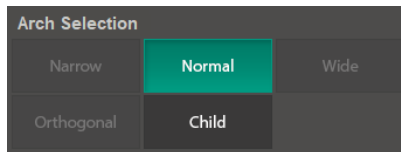

4. Select a patient type.

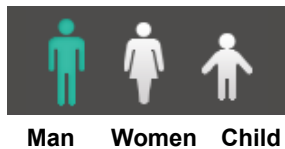

Patient	VATECH standard
Man	Males over the age of 12
Woman	Females over the age of 12
Child	Male or Female under the age of 12

7. How to Acquire PANO Images

- Select an X-ray intensity level.

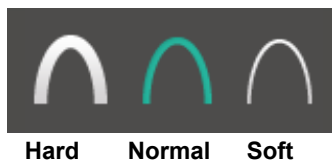

Category	Average head circumference (cm)	Range (cm)	Intensity level
Child (Age 12 or under)	53±3	>53±3	Hard
		53±3	Normal
		<53±3	Soft
Adult (Above Age 12)	56±3	>56±3	Hard
		56±3	Normal
		<56±3	Soft

- Once the X-ray intensity level is selected, the system automatically sets the exposure condition. To change the condition, click the plus-minus button next to the voltage and the current symbol.



Each time you click the button, the voltage value changes by **±1.0 kVp**, and the current value by **±1.0 mA**.

The table below shows the range of exposure conditions you can adjust.

Mode	Minimum Value		Maximum Value	
	kVp	mA	kVp	kVp
PANO	60	4	90	14

7. Click **Confirm**. Once clicked you cannot change the selected settings and the system operates as below:

A dark grey rectangular button with the word "Confirm" in white text.

- The rotating unit moves to the scanning position.
- Laser beams are turned on.
- The progress bar appears above the Confirm button.
- The **scan information window** shows the estimated DAP (Dose Area Product), scan time, and exposure time.

A blue rectangular box with the word "NOTICE" in white, bold, italicized text.

When the progress bar reaches 100%, the **Confirm** button turns into the **Ready** button.

8. Guide the patient to the X-ray room when you see the message below.

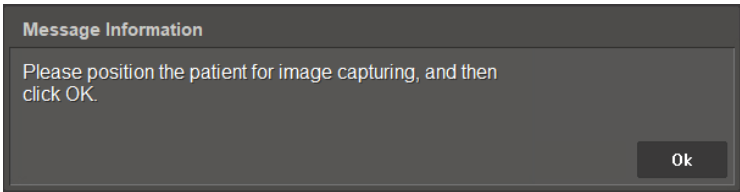
A dark grey dialog box with a title bar "Message Information". The main text area contains the instruction "Please position the patient for image capturing, and then click OK." and an "Ok" button in the bottom right corner.

Message Information

Please position the patient for image capturing, and then click OK.

Ok

7.3.3 TMJ Mode (LAT / PA)

You can set exposure settings for the TMJ mode after selecting the Special tab on the PANO console main window.

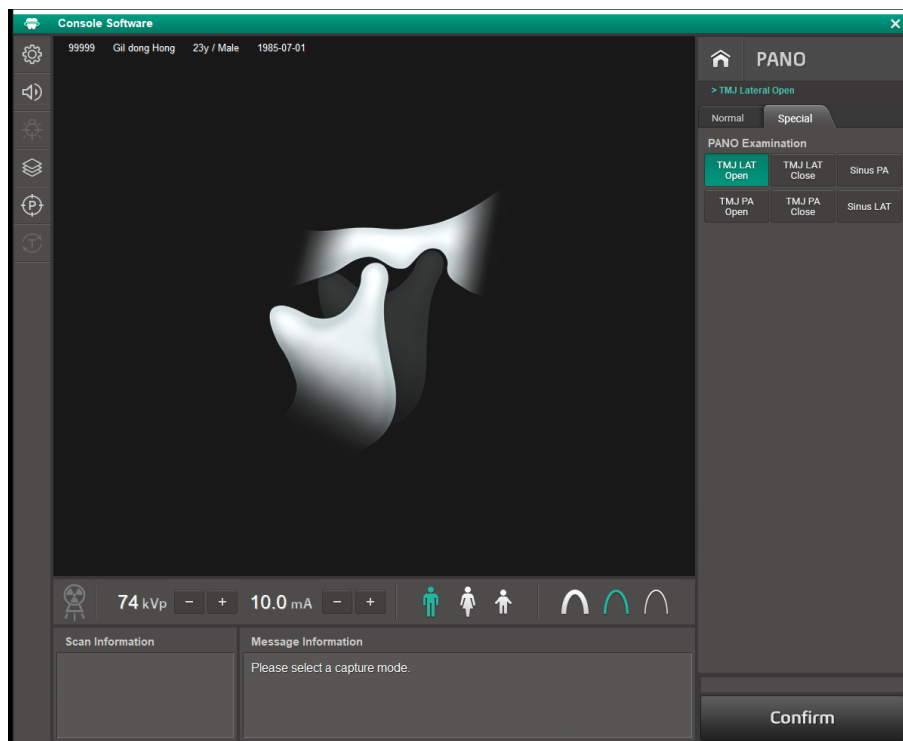

NOTICE

The console software's GUI and features can be changed without notice due to continuous product enhancement.

Follow the steps below to select exposure settings for the console software.

1. Select a TMJ option on the PANO Examination menu.

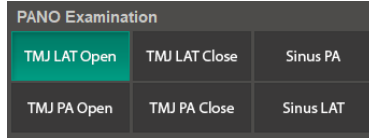

2. Select a patient type.



Man Women Child

Patient	VATECH standard
Man	Males over the age of 12
Woman	Females over the age of 12
Child	Male or Female under the age of 12

3. Select an X-ray intensity level.



Hard Normal Soft

Category	Average head circumference (cm)	Range (cm)	Intensity level
Child (Age 12 or under)	53±3	>53±3	Hard
		53±3	Normal
		<53±3	Soft
Adult (Above Age 12)	56±3	>56±3	Hard
		56±3	Normal
		<56±3	Soft

7. How to Acquire PANO Images

- Once the X-ray intensity level is selected, the system automatically sets the exposure condition. To change the condition, click the plus-minus button next to the voltage and the current symbols.



Each time you click the button, the voltage value changes by ± 1.0 kVp, and the current value by ± 1.0 mA.

The table below shows the range of exposure conditions you can adjust.

Mode	Minimum Value		Maximum Value	
	kVp	mA	kVp	kVp
PANO	60	4	90	14

- Click **Confirm**. Once clicked you cannot change the selected settings and the system operates as below:



- The rotating unit moves to a scanning position.
- Laser beams are turned on.
- The progress bar appears above the Confirm button.
- The **scan information window** shows the estimated DAP(Dose Area Product), scan time, and exposure time.

NOTICE

When the progress bar reaches 100%, the **Confirm** button turns into the **Ready** button.

- Guide the patient to the X-ray room when you see the message below.

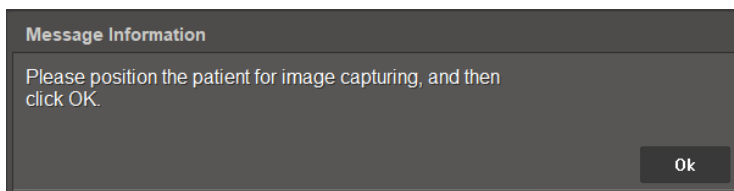

7.3.4 Sinus Mode (LAT / PA)

Select **Sinus** on the PANO examination menu and follow the same steps as shown in the 7.3.3 TMJ Mode (LAT / PA).

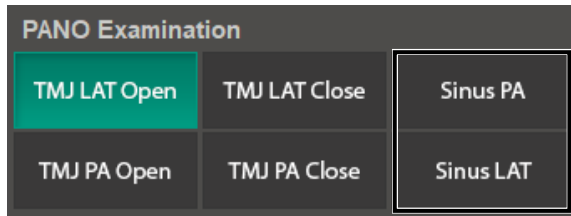

7.4 Patient Positioning

Start patient positioning when the equipment stops moving after clicking **confirm**.



Do not guide the patient into the X-ray room while the equipment is moving.

NOTICE

When acquiring a panoramic image, the **chinrest up/down button** is disabled by default.

7.4.1 Normal and Insight PAN Mode

Follow the steps below to position the patient.

NOTICE

Use **special bite B** to capture a normal and Insight PAN image for the edentulous patients,

1. Remove all metal objects that the patient wears.

NOTICE

Metal objects can cause ghosts or shadows on the X-ray image and lower the image quality.

2. Ask the patient to wear a lead apron. If necessary, help the patient to put on the apron.
3. Use the **column up/down button** to adjust the column's height for the patient.

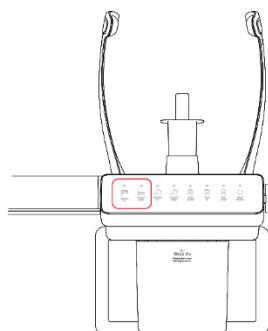
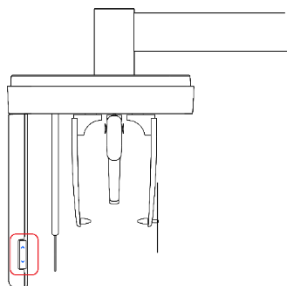

CAUTION

Ensure that the patient does not collide with the equipment while it is moving.

4. Ask the patient to enter the equipment and give the following instructions:
 - Stand straight.
 - Grab handles with both hands.
 - Place the chin on the chinrest.
 - Gently bite on the bite block's groove with the front teeth.
5. Adjust the patient's position according to the laser beam's location.
 - The **vertical beam** must be aligned with the patient's **mid-sagittal plane**. If necessary, center the patient's head.
 - The **horizontal beam** must be aligned with the patient's **Frankfurt plane**. Use the **beam up/down button** to change the beam's location.
 - Check if the **shoulder beam** touches the patient's **shoulder**. If necessary, ask the patient to lower his or her shoulder.



Ensure that the laser beam does not meet with the patient's eyes during positioning. Direct contact with beams can cause vision loss.

6. Check if the **canine beam** comes at the patient's canine tooth. If necessary, use the **canine teeth beam lever** to change the beam's location.

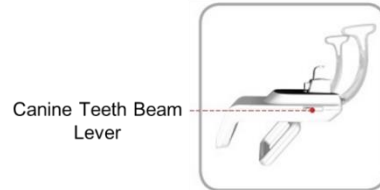
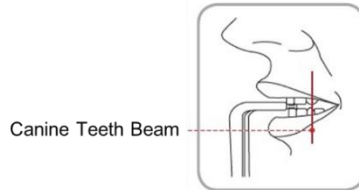

7. Ask the patient to place his or her tongue on the roof of the mouth and close the eyes.
8. Turn the **temple supports knob** to close the temple supports.
9. Leave the X-ray room and follow the instructions in **7.5 Acquiring Images**.

IMPORTANT

Review the patient's position before leaving the X-ray room. If necessary, reposition the patient.

7.4.2 TMJ Mode (LAT/ PA)

Follow the steps below to position the patient. In the TMJ mode, the system captures images, following a sequence from TMJ open mode to TMJ close.

NOTICE

When scanning for the TMJ mode, position the patient first for the TMJ open mode, then for the TMJ close mode.

1. Insert the **special bite A** into the chinrest.
2. Remove all metal objects that the patient wears.

NOTICE

Metal objects can cause ghosts or shadows on the X-ray image and lower the image quality.

3. Ask the patient to wear a lead apron. If necessary, help the patient to put on the apron.
4. Use the **column up/down button** to adjust the column's height for the patient.

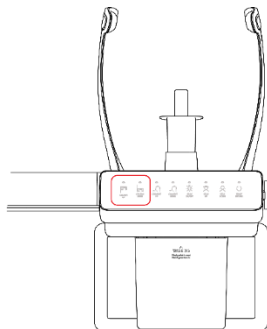
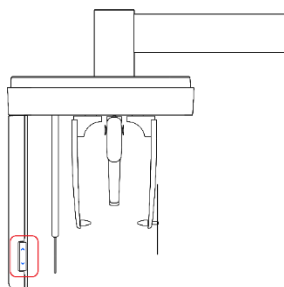

CAUTION

Ensure that the patient does not collide with the equipment while it is moving.

5. Ask the patient to enter the equipment and give the following instructions:
 - Stand straight.
 - Grab handles with both hands.
 - Place the chin on the chinrest.

6. Ask the patient to press his or her acanthion point against the **special bite A** and tilt the head **forward at 5**. Ensure that the patient's jaw does not touch the equipment.
7. Adjust the patient's position according to the laser beam's location.
 - The **vertical beam** must be aligned with the patient's **mid-sagittal plane**. If necessary, center the patient's head.
 - The **horizontal beam** must be aligned with the patient's **Frankfurt plane**. Use the **beam up/down button** to change the beam's location.



Ensure that the laser beam does not meet with the patient's eyes during positioning. Direct contact with beams can cause vision loss.

8. Ask the patient to open his or her mouth and close eyes.
9. Use the temple supports knob to close the temple supports to secure the patient's head.
10. Leave the X-ray room and follow the instructions in **7.5 Acquiring Images**.

IMPORTANT

Review the patient's position before leaving the X-ray room. If necessary, reposition the patient.

TMJ Close Mode Patient Positioning

Follow the steps below to position the patient.

1. Click **OK** when the message information window says, "Do you want to capture a TMJ close image?"
2. Ask the patient to press the acanthion point against the special bite A and tilt the head forward at 5°. Ensure that the patient's jaw does not touch the
3. Adjust the patient's position according to the laser beam's location.
 - The **vertical beam** must be aligned with the patient's **mid-sagittal plane**. If necessary, center the patient's head.
 - The **horizontal beam** must be aligned with the patient's **Frankfurt plane**. Use the **beam up/down button** to change the beam's location.



Ensure that the patient does not have eye contact with the laser beams during the positioning. The Laser beams can damage the patient's eyes.

4. Ask the patient to open his or her mouth and close eyes.
5. Use the temple supports knob to close the temple supports to secure the patient's head.
6. Leave the X-ray room and follow the instructions in **7.5 Acquiring Images**.

IMPORTANT

Review the patient's position before leaving the X-ray room. If necessary, reposition the patient.

7.4.3 Sinus Mode (LAT / PA)

Follow the steps below to position the patient.

1. Remove all metal objects that the patient wears.

NOTICE

Metal objects can cause ghosts or shadows on the X-ray image and lower the image quality.

2. Ask the patient to wear a lead apron. If necessary, help the patient to put on the apron.
3. Use the **column up/down button** to adjust the column's height for the patient.

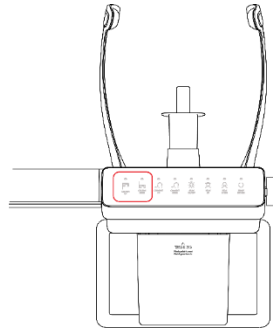
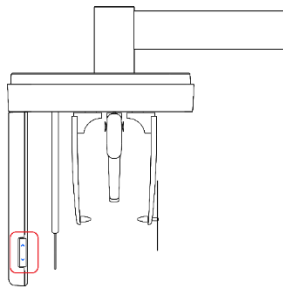

CAUTION

Ensure that the patient does not collide with the equipment while it is moving.

4. Ask the patient to enter the equipment and give the following instructions:
 - Stand straight.
 - Grab handles with both hands.
 - Place the chin on the chinrest.
5. Ask the patient to press the acanthion point against the chinrest and tilt **forward at 5°**. Ensure that his or her jaw does not touch the equipment.

6. Adjust the patient's position according to the laser beam's location.
 - The **vertical beam** must be aligned with the patient's **mid-sagittal plane**. If necessary, center the patient's head.
 - The **horizontal beam** must be aligned with the patient's **Frankfurt plane**. Use the **beam up/down button** to change the beam's location.



Ensure that the laser beam does not meet with the patient's eyes during positioning. Direct contact with beams can cause vision loss.

7. Ask the patient to open his or her mouth and close eyes.
8. Use the temple supports knob to close the temple supports to secure the patient's head.
9. Leave the X-ray room and follow the instructions in **7.5 Acquiring Images**.

IMPORTANT

Review the patient's position before leaving the X-ray room. If necessary, reposition the patient.

7.5 Acquiring Images

Follow the steps below to acquire an X-ray image.



Do not use the PC while capturing an image. This can cause a problem with equipment or software's operation.



In an emergency, release the **exposure switch** and press the **emergency stop switch**. The equipment immediately stops after pressing the switch.



Stay in communication with the patient during the image capture. The user must be able to communicate with the patients visually or verbally for their safety.

1. Click **Ready** on the console software. X-ray emission does not start yet.



2. Press the exposure switch when the message information window says, "Please press and hold the X-ray exposure switch until image capturing is completed."

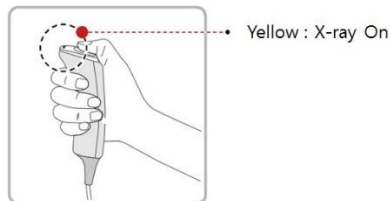

When you press the exposure switch,

- The LED on the vertical unit turns yellow.
 - The LED on the exposure switch flickers yellow.
 - The X-ray exposure status on the console software turns yellow.
3. Release the exposure switch when the message information window says, "**Image capturing is complete.**"

IMPORTANT

Do not release the exposure switch until you see the message. Early release of the exposure switch can disturb the image capture.

7.6 After Acquiring Images

Follow the steps below after the image acquisition.

1. Use the **temple support knob** to open the temple supports.
2. Guide the patient to leave the X-ray room.
3. Remove the sanitary vinyl cover from the bite block.



WARNING

The equipment returns to its initial position after capturing the image. Ensure that the patient does not leave the equipment until it stops moving.

7.7 Checking the Acquired Images

Follow the steps below to check the acquired images.

1. Click **Save** to save the captured images. You can skip this step if you already select the Auto Save option before scanning.

NOTICE

Click **Retake** to capture another image.

NOTICE

How to Select the Auto Save Option

- 1) Select the Settings button on the console window.
- 2) Select **User > Image Save option**, and check the box to apply the Auto Save.

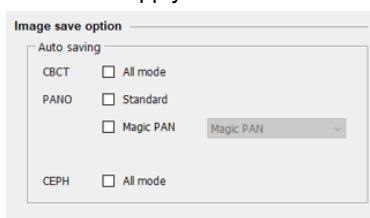

- 3) Click **Save**.

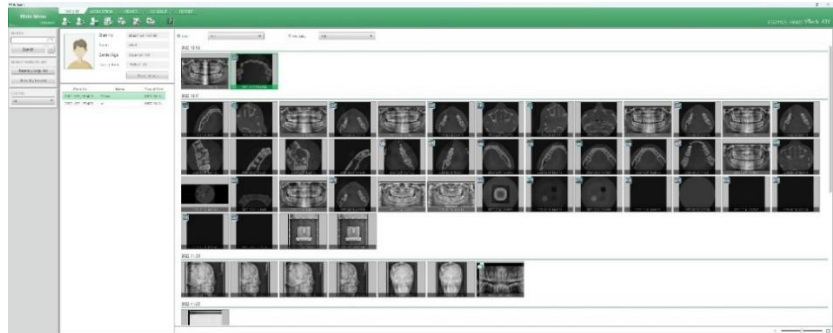

2. Select the **PATIENT** tab on the **EzDent-i** window. Select and double-click the image you want to view.

**NOTICE**

You can select one image at a time.

3. The selected image is open on the **VIEWER** Tab of the **EzDent-i**.

This Page Intentionally Left Blank

8. How to Acquire CEPH Images (Optional)

8.1 Program Overview

■ Result Images



It provides conventional 2D cephalometric images.

■ Image Acquisition Method

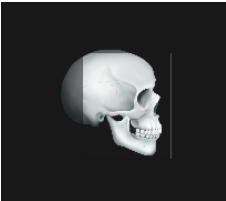

It acquires multiple images by scanning the specific oral & maxillofacial regions with the linear movement of the linear detector and reconstructs them into a single 2D image through computer calculations.

■ Examination Programs

It is classified as below based on the ROI (Region of Interest).

CEPH Examination	Description	Position
Lateral/ Full Lateral (Optional)	<ul style="list-style-type: none"> Used to study craniofacial disease, trauma, and congenital malformation and examine the soft tissue in the otorhinolaryngological area, the sinus, and the hard palate. Measures the angles formed by the connecting lines between the cranial measurement points to further assess the growth of the facial region. It's widely used in Orthodontics and Oral and Maxillofacial Surgery. 	 <p><Lateral></p>  <p><Full Lateral></p>
PA	<ul style="list-style-type: none"> The radiation is directed from the posterior of the skull to the anterior. It is used to examine cranial diseases, trauma, and congenital malformations. It is used to assess the growth of the lateral side of the face. It is also used to examine the ramus mandibulae, the posterior region of the third-largest molar in the lower jaw, the sidewall of the maxillary sinus, the frontal sinus, antrum 	 <p><PA></p>

8. How to Acquire CEPH Images (Optional)

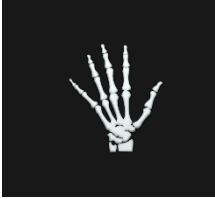
CEPH Examination	Description	Position
	<p>ethmoidal olfactory pits, and optic disc pits.</p> <ul style="list-style-type: none"> Measures the angles formed by the connecting lines between the cranial measurement points to further assess the growth of the facial region. It is widely used in Orthodontics and Oral and Maxillofacial Surgery. 	
SMV	<ul style="list-style-type: none"> Used to study the base of the skull, horizontal angulation of the mandibular condylar axis, the sphenoid sinus, the curvature of the lower jaw, the sidewall of the maxillary sinus, and zygomatic arch fractures. Also used to study the inner and outer alar plates and holes at the base of the skull. 	 <p data-bbox="1023 799 1098 823"><SMV></p>
Waters' View	<ul style="list-style-type: none"> Used to study the frontal sinus, the antrum ethmoidal, the optic disc pit, the frontozygomatic suture, the nasal cavity, and the coronoid process between the upper jaw and the zygomatic arch. 	 <p data-bbox="989 1074 1133 1097"><Waters' view></p>
Carpus	<ul style="list-style-type: none"> Used to assess hand bone age to compare the changes in the skull. 	 <p data-bbox="1009 1344 1105 1367"><Carpus></p>

8.2 Preparing X-ray System

8.2.1 Carpus Scan

Before starting a carpus scan, install the carpus plate.

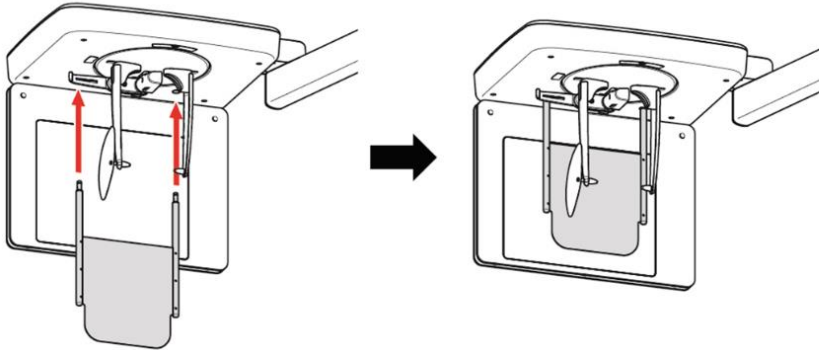

8.2.2 Other Scan Modes

Before starting a CEPH scan, follow the steps below.

1. Clean equipment accessories and parts that directly contact the patient.
2. Put the ear rods.
3. Put a nasal positioner cover on the nasal positioner.

8.3 Selecting Exposure Settings

Follow the step below to select exposure settings for the CEPH mode.

1. Open the **EzDent-i** window and select the Acquisition tab.

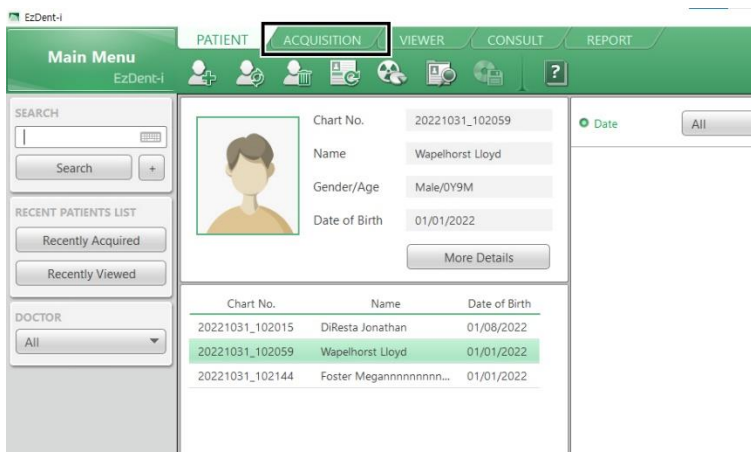

2. Select **CEPH** from the imaging menu on the left. The main CEPH console window appears after selection.

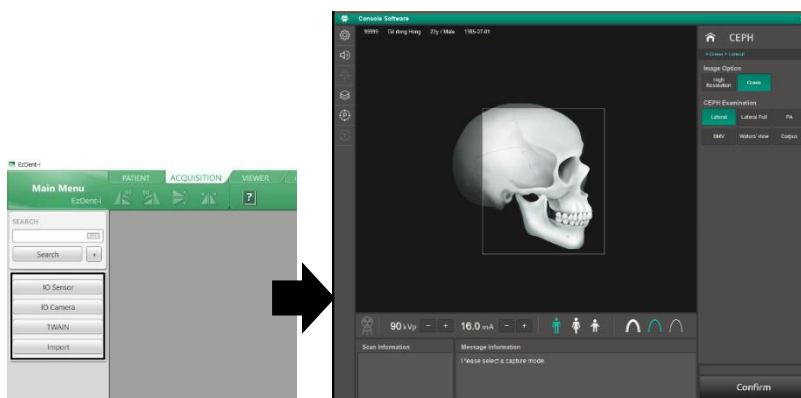

3. Select an **image option**.

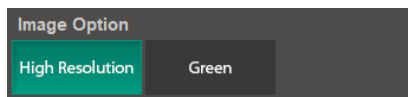

Mode	Description
High Resolution	High-Resolution image
Green	Normal-Resolution image

4. Select a **CEPH examination** option.

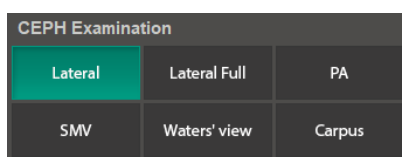

5. Select a **patient type**.



Man Women Child

Patient	VATECH standard
Man	Males over the age of 12
Woman	Females over the age of 12
Child	Male or Female under the age of 12

6. Select an **X-ray intensity level**.



Hard Normal Soft

Category	Average head circumference (cm)	Range (cm)	Intensity level
Child (Age 12 or under)	53±3	>53±3	Hard
		53±3	Normal
		<53±3	Soft

8. How to Acquire CEPH Images (Optional)

Adult (Above Age 12)	56±3	>56±3	Hard
		56±3	Normal
		<56±3	Soft

- Once the X-ray intensity level is selected, the system automatically sets the exposure condition. To change the condition, click the **plus-minus button** next to the voltage and the current symbols.



Each time you click the button, the voltage value changes by ± 1.0 kVp, and the current value by ± 1.0 mA.

The table below shows the range of the exposure conditions you can adjust.

Mode	Minimum values		Maximum Values	
	kVp	mA	kVp	mA
Lateral	60	4	99	15
Others	60	4	99	14

- Click **Confirm**. Once clicked, you cannot change the selected settings and the system operates:



- The progress bar appears above the Confirm button.
- The scan information window** shows the estimated DAP (Dose Area Product), scan, and exposure time.

NOTICE

When the progress bar reaches 100%, the Confirm button turns into the Ready button.

- Guide the patient to the X-ray room when you see the message below.

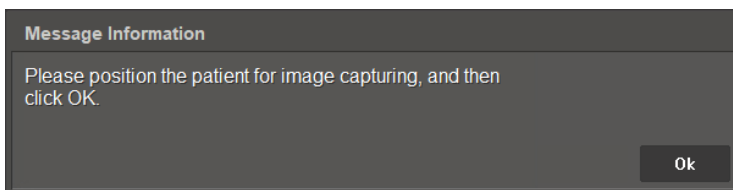

8.4 Patient Positioning

8.4.1 Lateral / Full Lateral (Optional) Mode

Follow the steps below to position the patient for the lateral mode.

1. Remove all metal objects that the patient wears.

NOTICE

Metal objects can cause ghosts or shadows on the X-ray image and lower the image quality.

2. Turn the nasal positioner to the Lateral / Full lateral mode marker.
3. Use the **column up/down button** to adjust the equipment's height.

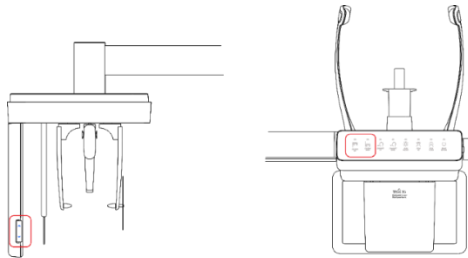

CAUTION

Ensure that the patient does not collide with the equipment while it is moving.

4. Make space between two ear rods for the patient's head.
5. Ask the patient to stand straight under the CEPH unit.
6. Slid the ear rods until their tips gently touch the patient's outer ear canals.

CAUTION

Do not slide ear rods until adjusting the equipment's height is finished.

8. How to Acquire CEPH Images (Optional)

7. Give the patient the following instructions:
 - Close his or her eyes.
 - Swallow
 - Stay in the same position.
8. Leave the X-ray room and follow the instructions in **8.5 Acquiring Images**.

IMPORTANT

Review the patient's position before leaving the X-ray room. If necessary, reposition the patient.

8.4.2 PA Mode

Follow the steps below to position the patient for the PA mode.

1. Remove all metal objects that the patient wears.

NOTICE

Metal objects can cause ghosts or shadows on the X-ray image and lower the image quality.

2. Turn the nasal positioner to the PA / Waters' view / Carpus marker and fold the positioner up.
3. Use the **column up/down button** to adjust the equipment's height.

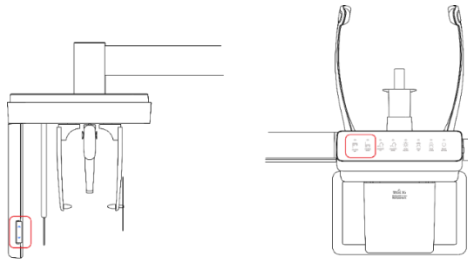

CAUTION

Ensure that the patient does not collide with the equipment while it is moving.

4. Make space between two ear rods for the patient's head.
5. Ask the patient to stand straight under the CEPH unit, facing the sensor.
6. Slid the ear rods until their tips gently touch the patient's outer ear canals.

CAUTION

Do not slide ear rods until adjusting the equipment's height is finished.

7. Give the patient the following instructions:
 - Close his or her eyes.
 - Swallow
 - Stay in the same position.
8. Leave the X-ray room and follow the instructions in **8.5 Acquiring Images**

IMPORTANT

Review the patient's position before leaving the X-ray room. If necessary, reposition the patient.

8.4.3 SMV Mode

Follow the steps below to position the patient for the SMV mode:

1. Remove all metal objects that the patient wears.

NOTICE

Metal objects can cause ghosts or shadows on the X-ray image and lower the image quality.

2. Use the **column up/down button** to adjust the equipment's height.

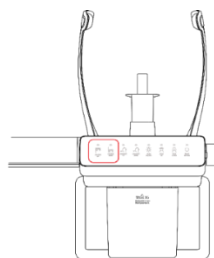
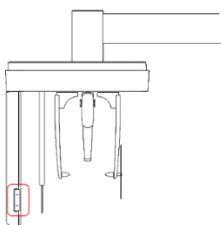

CAUTION

Ensure that the patient does not collide with the equipment while it is moving.

3. Make space between two ear rods for the patient's head.
4. Ask the patient to stand straight in the opposite direction of the sensor.

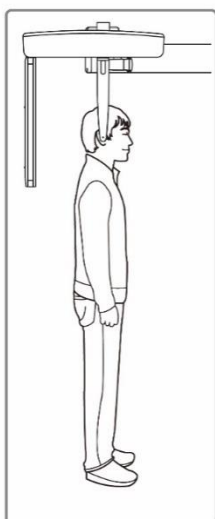

5. Slid the ear rods until their tips gently touch the patient's outer ear canals.



Do not slide ear rods until adjusting the equipment's height is finished.

6. Carefully tilt the patient's head back until his or her Frankfurt line (plane) lies vertical to the floor.

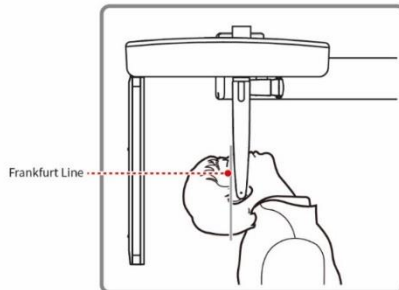

7. Give the patient the following instructions:
 - Close his or her eyes.
 - Swallow
 - Stay in the same position.
8. Leave the X-ray room and follow the instructions in **8.5 Acquiring Images**.

IMPORTANT

Review the patient's position before leaving the X-ray room. If necessary, reposition the patient.

8.4.4 Waters' View Mode

Follow the steps below to position the patient for the water's view mode:

1. Remove all metal objects that the patient wears.

NOTICE

Metal objects can cause ghosts or shadows on the X-ray image and lower the image quality.

2. Turn the nasal positioner to the Water's view marker and fold the positioner up.
3. Use the column up/down button to adjust the equipment's height.

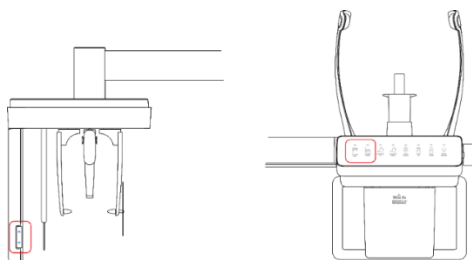

CAUTION

Ensure that the patient does not collide with the equipment while it is moving.

4. Make space between two ear rods for the patient's head.
5. Ask the patient to stand straight, facing the X-ray sensor.
6. Slid the ear rods until their tips gently touch the patient's outer ear canals.

CAUTION

Do not slide ear rods until adjusting the equipment's height is finished.

7. Ask the patient to tilt his or her neck back to 30°~ 40, as shown in the image below.

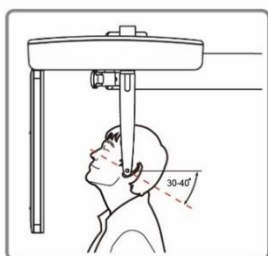

8. Give the patient the following instructions:
 - Close his or her eyes.
 - Swallow
 - Stay in the same position.
9. Leave the X-ray room and follow the instructions in **8.5 Acquiring Images**.

IMPORTANT

Review the patient's position before leaving the X-ray room. If necessary, reposition the patient.

8.4.5 Carpus Mode

Follow the steps below to position the patient for the carpus mode:



Ensure that the carpus plate is installed and secured before positioning the patient.

1. Remove all metal objects that the patient wears.



Metal objects can cause ghosts or shadows on the X-ray image and lower the image quality.

2. Turn the nasal positioner to the PA / Water's view / Carpus mode marker and fold it up.
3. Ask the patient to place his or her right hand on the carpus plate. Ensure that all five fingers are fully stretched out and the patient's palm lies flat on the plate.
4. Give the patient the following instructions:
5. Instruct the patient to:
 - Stay in the same position.
 - Close his or her eyes.
6. Leave the X-ray room and follow the instructions in **8.5 Acquiring Images**.



Review the patient's position before leaving the X-ray room. If necessary, reposition the patient.

8.5 Acquiring Images

Follow the steps below to acquire an X-ray image.



Do not use the PC while capturing an image. This can cause a problem with equipment or software's operation.



In an emergency, release the **exposure switch** and press the **emergency stop switch**. The equipment immediately stops after pressing the switch.



Stay in communication with the patient during the image capture. The user must be able to communicate with the patients visually or verbally for their safety.

1. Click **Ready** on the console software. X-ray emission does not start yet.



2. Press the exposure switch when the message information window says, "Please press and hold the X-ray exposure switch until image capturing is completed."

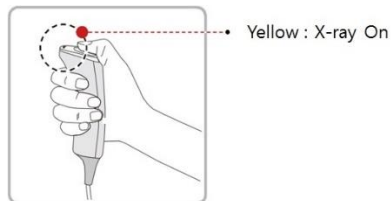

When you press the exposure switch,

- The LED on the vertical unit turns yellow.
 - The LED on the exposure switch flickers yellow.
 - The X-ray exposure status on the console software turns yellow.
3. Release the exposure switch when the message information window says, "**Image capturing is complete.**"

IMPORTANT

Do not release the exposure switch until you see the message. Early release of the exposure switch can disturb the image capture.

8.6 After Acquiring Images

Follow the steps below after the image acquisition.

1. Slid the **ear rods** back to their pre-scanning position.
2. Fold up the **nasal positioner** if necessary.
3. Remove the **carpus plate**, if necessary.
4. Guide the patient to leave the X-ray room.



WARNING

The equipment returns to its initial position after capturing the image. Ensure that the patient does not leave the equipment until it stops moving.

8.7 Checking the Acquired Images

Follow the steps below to check the acquired images.

1. Click **Save** to store the acquired images. You may skip this step if you selected the **Auto Save option** before image acquisition.

NOTICE

Click **Retake** to capture another image.

NOTICE

How to Select the Auto Save Option

- 1) Select the Settings button on the console window.
- 2) Select **User > Image Save option**, and check the box to apply the Auto Save.

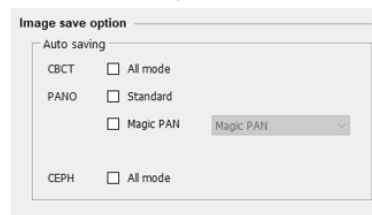

- 3) Click **Save**.



2. Select the **PATIENT** tab on the **EzDent-i** window. Select and double-click the image you want to view.

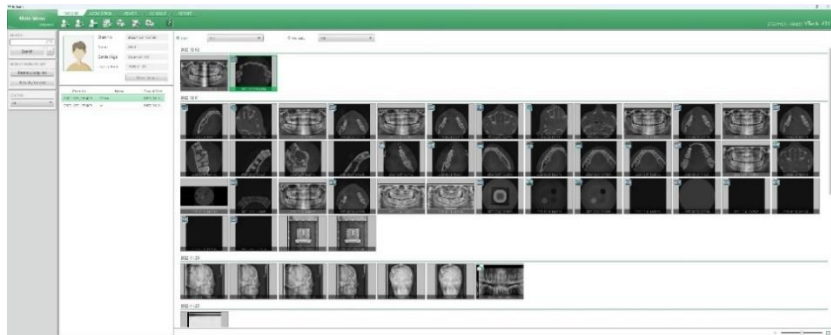

NOTICE

You can select one image at a time.

3. The selected image is open on the **VIEWER** tab of the **EzDent-**

9. How to Acquire CBCT Images

9.1 Program Overview

■ **Role**

CBCT program provides 3D CT sliced images.

■ **Image Acquisition Method**



The system acquires images with the X-ray beam scanning specific oral & maxillofacial regions and reconstructs them into 3D sliced images.

■ **Examination Programs**

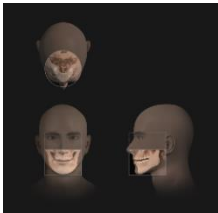
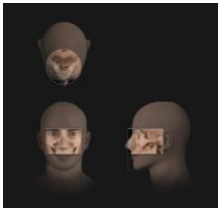
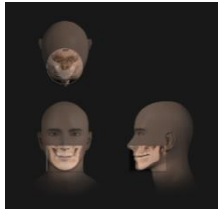
CBCT program consists of options categorized by FOV and ROI(Region of Interest)

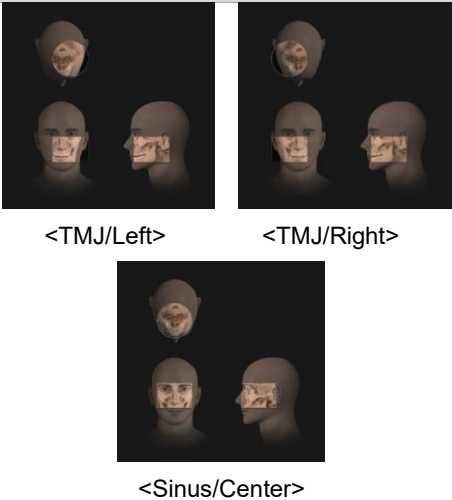
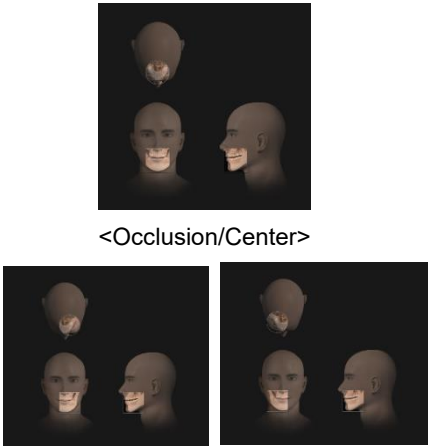
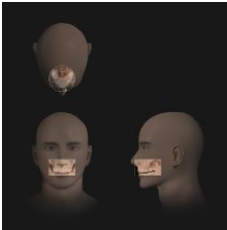
FOV (cm)	ROI	Description
Double Scan (12x14)	 <Mandible/Center>	- Full Arch, sinus, left and right TMJ area can be checked - Suitable for most intra-oral surgery, including multiple implant placement
	 <Maxilla/Center>	
12x8.5	 <Occlusion/Center>	- Covers both maxillary and mandibular structures, including the 3 rd molar region. - TMJ Right/Left and Airway modes are available.

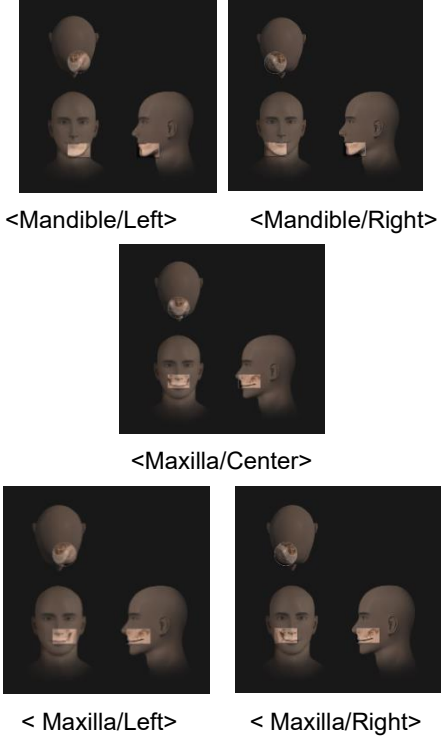
FOV (cm)	ROI	Description
	 <p data-bbox="515 490 639 517"><TMJ/Left></p> <p data-bbox="732 490 869 517"><TMJ/Right></p> <p data-bbox="609 741 773 768"><Sinus/Center></p>	
8x8	 <p data-bbox="587 1008 801 1035"><Occlusion/Center></p> <p data-bbox="491 1244 677 1271"><Occlusion/Left></p> <p data-bbox="716 1244 916 1271">< Occlusion/Right></p>	<p data-bbox="985 993 1185 1074">- Selectable FOV for the region (left/center/right).</p>
8x5	 <p data-bbox="592 1530 795 1557"><Mandible/Center></p>	<p data-bbox="985 1344 1185 1425">- Selectable FOV for the region (left/center/right).</p> <p data-bbox="985 1445 1185 1514">- Covers both maxillary and mandibular areas.</p>

FOV (cm)	ROI	Description
	 <p><Mandible/Left> <Mandible/Right></p> <p><Maxilla/Center></p> <p>< Maxilla/Left> < Maxilla/Right></p>	
<p>Smart Focus (12x8.5)</p>		<p>-Users can select up to three areas to view the selected areas in a 4x4 high-resolution image.</p>
<p>Endo (4x4)</p>		<p>- Covers 3~4 areas through capturing ROI. - Can acquire 3~4 teeth at once.</p>

NOTICE

The Endo mode FOV size is 40 x 40 mm², which is an area including 3~4 teeth. Before starting the X-ray exposure, check the status of wisdom teeth. Then select the location of the tooth for imaging to provide a scout function for accurate exposure.

9.2 Preparing X-ray System

Follow the steps below to prepare an image capture.

1. Clean accessories that are directly in contact with patients. Go to **12. Cleaning and Disinfection** for the cleaning procedure.



Chinrest, bite blocks, and other accessories that have direct contact with the patients must be cleaned before scanning with chlorine dioxide-based alcohol-free products.

2. Insert a bite block into the chinrest. Ensure to select the bite block suitable for your purpose.

Bite Block	Purpose
Normal Bite	For the normal mode and non-edentulous patients.
Special Bite B	For the normal mode and edentulous patients.
Special Bite A	For the special mode (TMJ and Sinus). This bite block is used for both edentulous and non-edentulous patients.

3. Insert left and right temple supports.
4. Put a sanitary vinyl cover on the bite block. Always change the cover after each scanning.

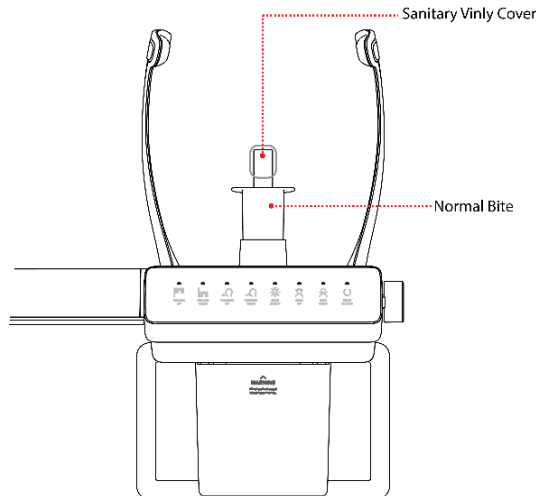



We highly recommend using the sanitary vinyl cover provided by VATECH. When you run out of stock, contact the manufacturer.



If you are using a sanitary vinyl cover from 3rd party. Ensure that your product complies with one of the following standards:

- ISO 10993-1(Biological evaluation of medical devices)
- FDA
- CE
- Local regulations in your area

5. Go to **9.3 Selecting Exposure Settings**.

9.3 Selecting Exposure Settings

Follow the steps below to open the CBCT console window.

1. Open the **EzDent-i** window and select the **ACQUISITION** tab.



2. Select CBCT from the capture mode menu. The CBCT console window will appear after the selection.

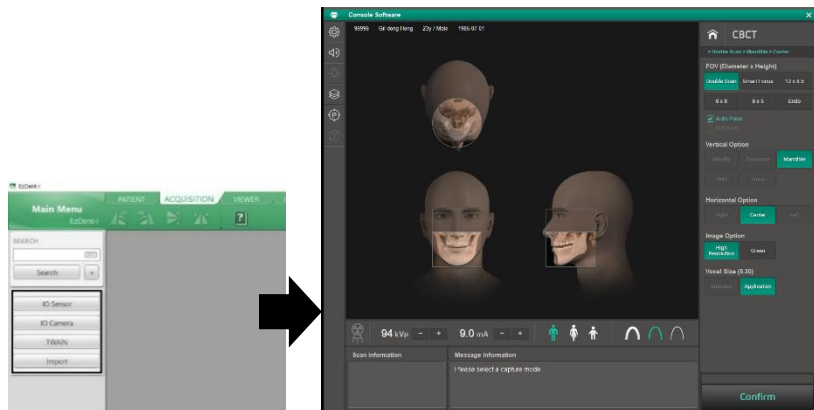

3. Select an option on the FOV menu and go to the corresponding section in the manual for a guide to select exposure settings.

- 9.3.1 Normal CBCT
- 9.3.2 Double Scan Mode
- 9.3.3 Smart Focus Mode
- 9.3.4 Endo Mode
- 9.3.5 Scout View

9.3.1 Normal CBCT

Follow the steps below to set exposure settings for a normal CBCT capture.

1. Select a **FOV**. The vertical and horizontal options are selected according to the FOV you chose.

FOV (Diameter x Height)		
Double Scan	Smart Focus	12 x 8.5
8 x 8	8 x 5	Endo

See the table below for the vertical and horizontal options corresponding to each FOV.

FOV	Vertical Option	Horizontal Option
12x8.5	Occlusion	Center
	TMJ	Right
		Left
	SINUS	Center
8x8	Occlusion	Right
		Center
		Left
8x5	Maxilla	Right
		Center
		Left
	Mandible	Right
		Center
		Left

NOTICE

To capture a TMJ or Sinus image, select 12x8.5 from the FOV menu.

- Check the **Auto Pano box** if you want to acquire both panoramic and CT images.



- Select a **vertical option**.

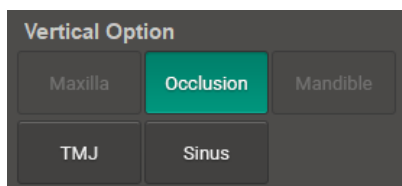

- Select a **horizontal option**.

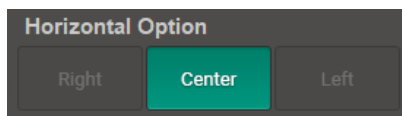

- Select an **image option**.

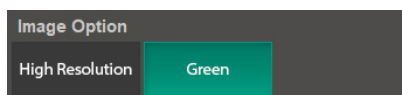

Option	Description
High Resolution	High-Resolution image
Green	Normal-Resolution image

- Select a **voxel size**.

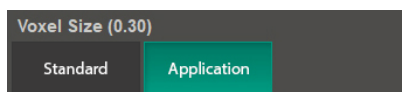

7. Select a **patient type**.



Man Women Child

Patient	VATECH standard
Man	Males over the age of 12
Woman	Females over the age of 12
Child	Male or Female under the age of 12

8. Select an **X-ray intensity level**.



Hard Normal Soft

Category	Average head circumference (cm)	Range (cm)	Intensity level
Child (Age 12 or under)	53±3	>53±3	Hard
		53±3	Normal
		<53±3	Soft
Adult (Above Age 12)	56±3	>56±3	Hard
		56±3	Normal
		<56±3	Soft

9. Once the X-ray intensity level is selected, the system automatically sets the exposure condition. To change the condition, click the **plus-minus button** next to the voltage and the current symbols.



Each time you click the button, the voltage value changes by ± 1.0 kVp, and the current value by ± 0.1 mA.

The table below shows the range of exposure conditions you can adjust.

Mode	Minimum Value		Maximum Value	
	kVp	mA	kVp	kVp
CBCT	60	4	99	14

10. Click **Confirm**. Once clicked you cannot change the selected settings and the system operates as below:



- The rotating unit moves to the scanning position.
- Laser beams are turned on.
- The progress bar appears above the Confirm button.
- The **scan information window** shows the estimated DAP (Dose Area Product), scan time, and exposure time.

NOTICE

When the progress bar reaches 100%, the **Confirm** button turns into the **Ready** button.

11. Guide the patient to the X-ray room when you see the message below.

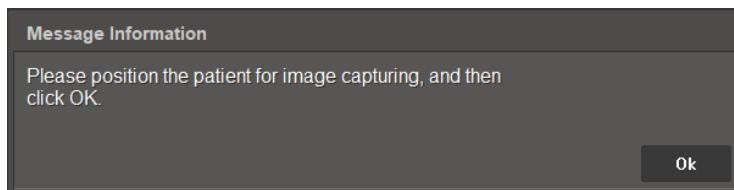

9.3.2 Double Scan Mode

In Double Scan mode, the mandible (lower jaw) is first scanned followed by the maxilla (upper jaw). But you need to select exposure settings only once. Once the first scan is completed, the system automatically sets the condition for the second scan.

Follow the steps below to select exposure conditions for the **Double Scan** mode.

1. Select **Double Scan** from the FOV menu. Once selected, the system automatically sets the vertical option (Mandible), horizontal option (Center), and voxel size (Application).



NOTICE

For the second scan, 'Maxilla' is automatically selected for the vertical option.

2. Check the **Auto Pano** box if you want to acquire both PANO and CT images.



3. Select an **image option**.

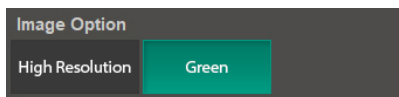

Option	Description
High Resolution	High-Resolution image
Green	Normal-Resolution image

4. Select a **patient type**.



Man Women Child

Patient	VATECH standard
Man	Males over the age of 12
Woman	Females over the age of 12
Child	Male or Female under the age of 12

5. Select an **X-ray intensity level**.



Hard Normal Soft

Category	Average head circumference (cm)	Range (cm)	Intensity level
Child (Age 12 or under)	53±3	>53±3	Hard
		53±3	Normal
		<53±3	Soft
Adult (Above Age 12)	56±3	>56±3	Hard
		56±3	Normal
		<56±3	Soft

6. Once the X-ray intensity level is selected, the system automatically sets the exposure condition. To change the condition, click the **plus-minus button** next to the voltage and the current symbols.



Each time you click the button, the voltage value changes by ± 1.0 kVp, and the current value by ± 0.1 mA.

9. How to Acquire CBCT Images

The table below shows the range of exposure conditions you can adjust.

Mode	Minimum Value		Maximum Value	
	kVp	mA	kVp	kVp
CBCT	60	4	99	14

- Click **Confirm**. Once clicked you cannot change the selected settings and the system operates as below:



- The rotating unit moves to the scanning position.
- Laser beams are turned on.
- The progress bar appears above the Confirm button.
- The **scan information window** shows the estimated DAP(Dose Area Product), scan time, and exposure time.



When the progress bar reaches 100%, the **Confirm** button turns into the **Ready** button.

- Guide the patient to the X-ray room when you see the message below.

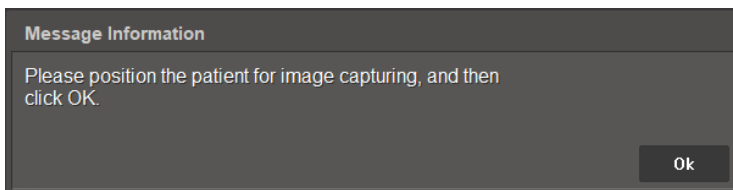

9.3.3 Smart Focus Mode

Follow the steps below to set exposure settings for the **Smart Focus** mode. In the Smart Focus mode, users can select the **Auto Pano** and **Full Arch** options.

1. Select **Smart Focus** from the FOV menu. After selection, the vertical and horizontal options are automatically selected by the system.

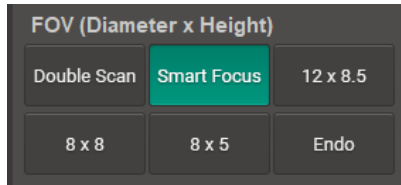

2. Check the boxes for **Auto Pano** or **Full Arch**. Check the box for the option you want to apply.



3. Select an **image option**.

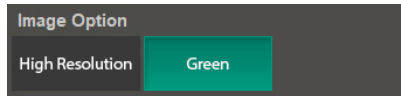

Mode	Description
High Resolution	High-Resolution image
Green	Normal-Resolution image

4. Select a **voxel size**.

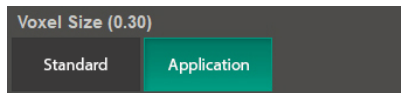

5. Select a **patient type**.



Patient	VATECH standard
Man	Males over the age of 12
Woman	Females over the age of 12
Child	Male or Female under the age of 12

6. Select an X-ray intensity level.



Hard Normal Soft

Category	Average head circumference (cm)	Range (cm)	Intensity level
Child (Age 12 or under)	53±3	>53±3	Hard
		53±3	Normal
		<53±3	Soft
Adult (Above Age 12)	56±3	>56±3	Hard
		56±3	Normal
		<56±3	Soft

7. Once the X-ray intensity level is selected, the system automatically sets the exposure condition. To change the condition, click the **plus-minus button** next to the voltage and the current symbols.



Each time you click the button, the voltage value changes by ± 1.0 kVp, and the current value by ± 0.1 mA.

The table below shows the range of exposure conditions you can adjust.

Mode	Minimum Value		Maximum Value	
	kVp	mA	kVp	kVp
CBCT	60	4	99	14

8. Click **Confirm**. Once clicked you cannot change the selected settings and the system operates as below:



- The rotating unit moves to the scanning position.
- Laser beams are turned on.
- The progress bar appears above the Confirm button.
- The **scan information window** shows the estimated DAP(Dose Area Product), scan time, and exposure time.

NOTICE

When the progress bar reaches 100%, the **Confirm** button turns into the **Ready** button.

9. Guide the patient to the X-ray room when you see the message below.

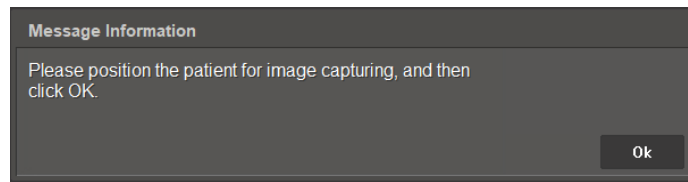

10. Follow **9.4.1 Other Capture Modes**.
11. [Image Selection] After taking the X-ray select the areas for image reconstruction. The selection can be made up of three.



12. Click **Complete** after selecting the areas.

IMPORTANT

Do not click **Complete** unless your selections are final. You cannot change settings after the button is clicked.

9.3.4 Endo Mode

Follow the steps below to set exposure settings for the **Endo** mode. In the Endo mode, you can choose whether to take a scout view image before scanning.

NOTICE

To take a scout view image, go to **9.3.5 Scout View**.

NOTICE

When taking an Endo mode, the system selects 'application' as the default voxel size.

1. Select **Endo** on the FOV menu.

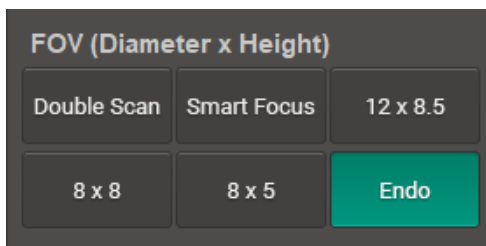

2. Select the area you want to capture an image.

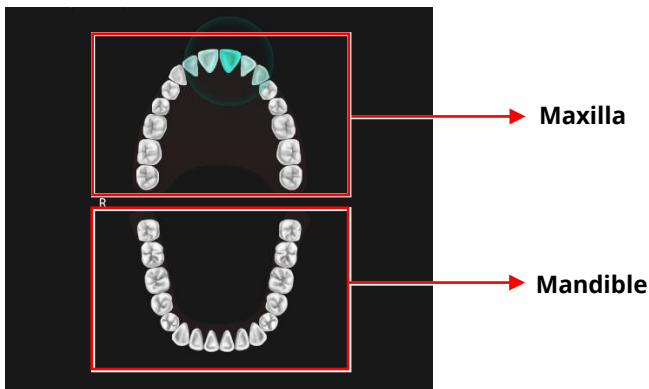

NOTICE

The selection window shows 32 teeth in total, including third molars. (Maxilla: 16, Mandible: 16).

3. Select an **image option**.

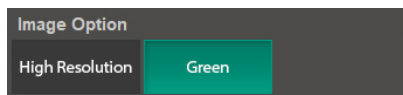

Mode	Description
High Resolution	High-Resolution image
Green	Normal-Resolution image

4. Select a **patient type**.



Man Women Child

Patient	VATECH standard
Man	Males over the age of 12
Woman	Females over the age of 12
Child	Male or Female under the age of 12

5. Select an **X-ray intensity level**.



Hard Normal Soft

Category	Average head circumference (cm)	Range (cm)	Intensity level
Child (Age 12 or under)	53±3	>53±3	Hard
		53±3	Normal
		<53±3	Soft
Adult (Above Age 12)	56±3	>56±3	Hard
		56±3	Normal
		<56±3	Soft

- Once the X-ray intensity level is selected, the system automatically sets the exposure condition. To change the condition, click the plus-minus button next to the voltage and the current symbols.



Each time you click the button, the voltage value changes by ± 1.0 kVp, and the current value by ± 0.1 mA.

Adjustable ranges for tube voltage and current are in the table below:

Mode	Minimum Value		Maximum Value	
	kVp	mA	kVp	kVp
CBCT	60	4	99	14

- Click **Confirm**. Once clicked you cannot change the selected settings and the system operates as below:



- The rotating unit moves to the scanning position.
- Laser beams are turned on.
- The progress bar appears above the Confirm button.
- The **scan information window** shows the estimated DAP(Dose Area Product), scan time, and exposure time.

NOTICE

When the progress bar reaches 100%, the **Confirm** button turns into the **Ready** button.

- When you see the message “Do you want to proceed with Scout capturing ?” from the message information window, click **NO**.

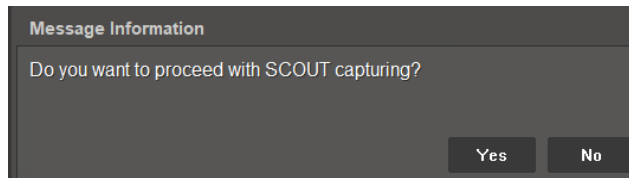
**NOTICE**

If you click **Yes**, follow the instructions in **9.3.5 Scout View** to acquire a scout view image and return to this section to complete the remaining steps.

- Guide the patient to the X-ray room when you see the message below.

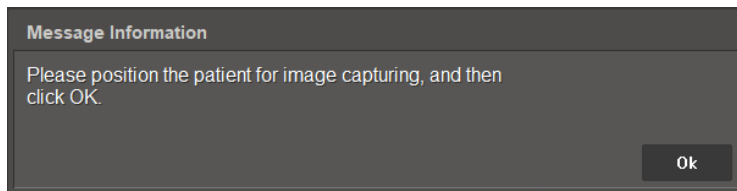

9.3.5 Scout View

If you select the Scout View option, you can confirm the capture location through a scout image before CT scanning and change it to the desired position. This option is available for the 8x5 and Endo modes only.

Follow the steps below to acquire a scout image.

1. Select **8x5** or **Endo** from the FOV menu.

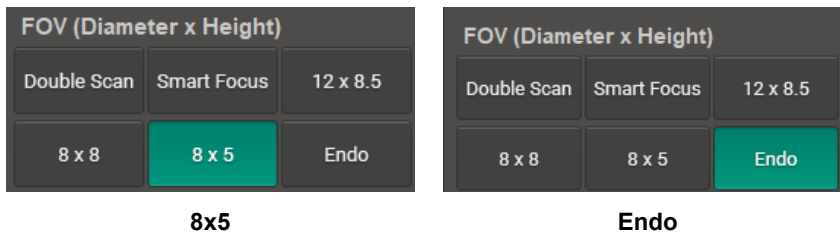

2. Select the exposure settings for the **8x5** or **Endo** mode.

NOTICE	Please read 9.3.1 Normal CBCT or 9.3.4 Endo Mode , for instructions on how to select exposure settings.
---------------	---

3. Position the patient according to the selected FOV. Once the patient positioning is completed, click **Confirm**.

NOTICE	Please read 9.4.1 Other Capture Modes , for instructions on how to align the patient's position.
---------------	---

4. When you see the message information window says, 'Do you want to proceed with SCOUT capturing?', click **'Yes'**.

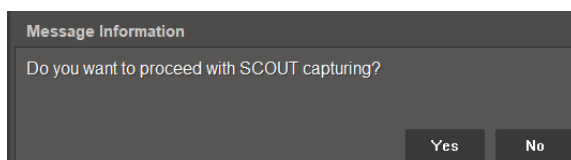

NOTICE	Click No if you want to skip the scout view imaging.
IMPORTANT	If the patient moves during Scout mode imaging, the capture location you selected may become incorrect. Please guide the patient to maintain their original position until the end.

5. Check the capture location in the scout image. To change the location, follow the steps below:
 - 1) Click the guideline (green lines) on the screen.
 - 2) Drag the guideline to the desired location.
 - 3) In the **8x5 mode**, you can move the line **up and down** to set a new capture location.
 - 4) In the **Endo mode**, you can move the lines in all four directions (**right, left, up, and down**) to set a new capture location.
6. Click **Set** after selecting the capture location. The chinrest will move down according to the adjusted location.

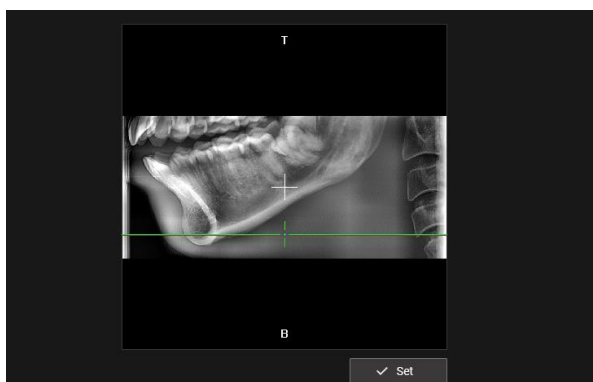

The 8x5 Mode Preview Image

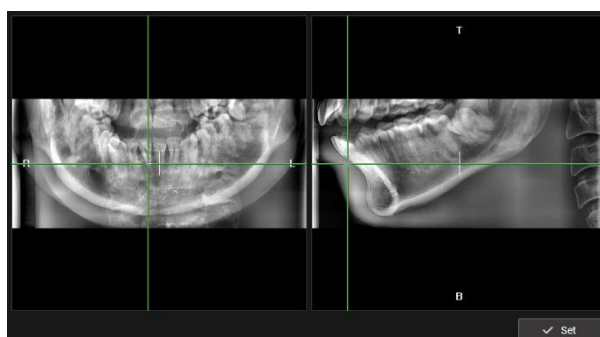

The Endo Mode Preview Image

IMPORTANT

Please guide the patient to maintain their position before clicking Set.

NOTICE

Do not click Set until you finalize the selection. You can use the Set button only once.

7. Follow the instructions in **9.5 Acquiring Images**.

9.4 Patient Positioning

9.4.1 Other Capture Modes

Follow the step below to position the patient for the CBCT capture except for the double scan mode.



Do not invite the patient to the X-ray room until the equipment stops moving.



For the CBCT mode, you cannot change the horizontal beam's position.

1. Remove all metal objects that the patient wears.



Metal objects can cause ghosts or shadows on the X-ray image and lower the image quality.

2. Ask the patient to wear a lead apron. If necessary, help the patient to put on the apron.
3. Use the **column up/down button** to adjust the column's height for the patient.

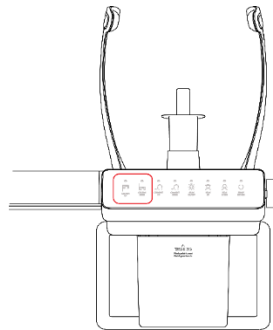
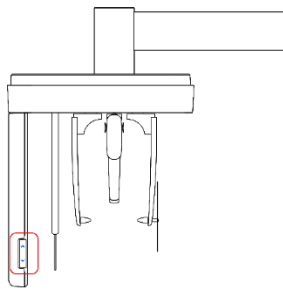

Ensure that the patient does not collide with the equipment while it is moving.

4. Turn the **temple supports knob** to open the temple supports.
5. Ask the patient to stand inside the equipment and give the following instructions:
 - Stand straight.
 - Grab handles with both hands.
 - Place the chin on the chinrest.
 - Gently bite on the bite block's groove with the front teeth.
6. Adjust the patient's position according to the laser beam's location.
 - The **vertical beam** must be aligned with the patient's **mid-sagittal plane**. If necessary, center the patient's head.
 - The **horizontal beam** must be aligned with the patient's **Frankfurt plane**. Use the **chinrest up/down button** to align the patient with the beam.
 - Check if the **shoulder beam** touches the patient's **shoulder**. If necessary, ask the patient to lower his or her shoulder.



Ensure that the laser beam does not meet with the patient's eyes during positioning. Direct contact with beams can cause vision loss.

7. Ask the patient to place his or her tongue on the roof of the mouth and close eyes.
8. Turn the **temple supports knob** to close the temple supports to secure the patient's head.
9. Leave the X-ray room and follow the instructions in **9.5 Acquiring Images**

IMPORTANT

Review the patient's position before leaving the X-ray room. If necessary, reposition the patient.

9.4.2 Double Scan Mode

For the double scan mode. The system scans the maxilla and mandible. For this reason, the patient needs to position for each scan.



Do not invite the patient to the X-ray room until the equipment stops moving.



For the CBCT mode, you cannot change the horizontal beam's position.

First Scan (Mandible Scan)

Follow the steps below to position the patient.

1. Remove all metal objects that the patient wears.



Metal objects can cause ghosts or shadows on the X-ray image and lower the image quality.

2. Ask the patient to wear a lead apron. If necessary, help the patient to put on the apron.
3. Use the **column up/down button** to adjust the column's height for the patient.

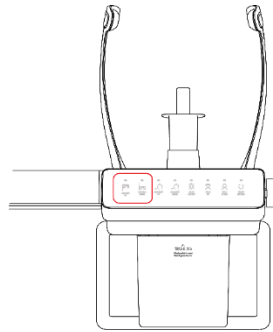
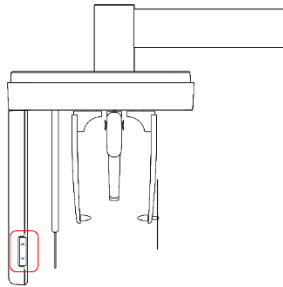

Ensure that the patient does not collide with the equipment while it is moving.

4. Turn the **temple supports knob** to open the temple supports.

9. How to Acquire CBCT Images

5. Ask the patient to stand inside the equipment and give the following instructions:
 - Grab handles with both hands and stand with your neck straight.
 - Place the chin on the chinrest.
 - Gently bite the bite block with the front teeth.
6. Adjust the patient's position according to the laser beam's location.
 - The **vertical beam** must be aligned with the patient's **mid-sagittal plane**. If necessary, center the patient's head.
 - The **horizontal beam** must be aligned with the patient's **Frankfurt plane**. Use the **chinrest up/down button** to align the patient with the beam.
 - Check if the **shoulder beam** touches the patient's **shoulder**. If necessary, ask the patient to lower his or her shoulder.



To prevent vision loss, ensure that the patient's eyes do not meet the laser beam during positioning

7. Ask the patient to place his or her tongue on the roof of the mouth and close eyes.
8. Turn the **temple supports knob** to close the temple supports to secure the patient's head.
9. Leave the X-ray room and follow the instructions in **9.5 Acquiring Images**

IMPORTANT

Review the patient's position before leaving the X-ray room. If necessary, reposition the patient.

Second Scan (Maxilla Scan)**NOTICE**

After the first (mandible) scan, the system automatically sets exposure settings for the second (maxilla) scan.

Follow the steps below to position the patient for the second scan.

1. After the first scan is complete, ask the patient to exit the equipment.



Instruct the patient to exit only after the equipment made a complete stop.

2. Click **Confirm** on the console window.



After clicking **Confirm**, the rotating unit will spin, and both the chinrest and column will go down for the maxilla scan.

3. After the first scan, the chinrest goes down. Guide the patient to open his or her mouth while the chin is placed on the chinrest.
 - Grab handles with both hands and stand with your neck straight.
 - Place the chin on the chinrest.
 - Gently bite the bite block with the front teeth.
4. Adjust the patient's position according to the laser beam's location.
 - The **vertical beam** must be aligned with the patient's **mid-sagittal plane**. If necessary, center the patient's head.
 - The **horizontal beam** must be aligned with the patient's **Frankfurt plane**. Use the **chinrest up/down button** to align the patient with the beam.
 - Check if the **shoulder beam** touches the patient's **shoulder**. If necessary, ask the patient to lower his or her shoulder.
5. Follow the instructions in **9.5 Acquiring Images** to complete the second (maxilla) scan.

9.5 Acquiring Images

Follow the steps below to capture an image.



Do not use the PC while capturing an image. This can cause a problem with equipment or software's operation.



In an emergency, release the **exposure switch** and press the **emergency stop switch**. The equipment immediately stops after pressing the switch.



Stay in communication with the patient during the image capture. The user must be able to communicate with the patients visually or verbally for their safety.

1. Click **Ready** on the console software. X-ray emission does not start yet.



2. Press the exposure switch when the message information window says, "Please press and hold the X-ray exposure switch until image capturing is completed."

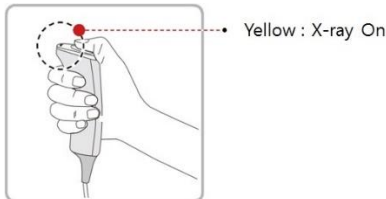

When you press the exposure switch,

- The LED on the vertical unit turns yellow.
 - The LED on the exposure switch flickers yellow.
 - The X-ray exposure status on the console software turns yellow.
3. Release the exposure switch when the message information window says, "**Image capturing is complete.**"

IMPORTANT

Do not release the exposure switch until you see the message. Early release of the exposure switch can disturb the image capture.

9.6 After Acquiring Images

Follow the steps below after the image acquisition.

1. Use the **template support knob** to open the template supports.
1. Guide the patient to leave the X-ray room.
2. Remove the sanitary vinyl cover from the bite block.



WARNING

The equipment returns to its initial position after capturing the image. Ensure that the patient does not leave the equipment until it stops moving.

9.7 Check the Acquired Images

Follow the steps below to check the acquired images.

1. Click **Save** to save the captured images. You can skip this step if you already select the Auto Save option before scanning.

NOTICE

Click **Retake** to capture another image.

NOTICE

How to Select the Auto Save Option

- 1) Select the Settings button on the console window.
- 2) Select **User > Image Save option**, and check the box to apply the Auto Save.

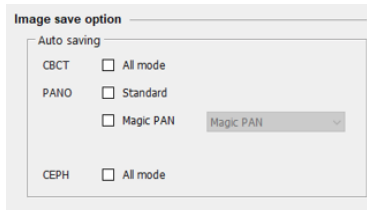

- 3) Click **Save**.



2. Select the **PATIENT** tab on the **EzDent-i** window. Select and double-click the image you want to view.

9. How to Acquire CBCT Images

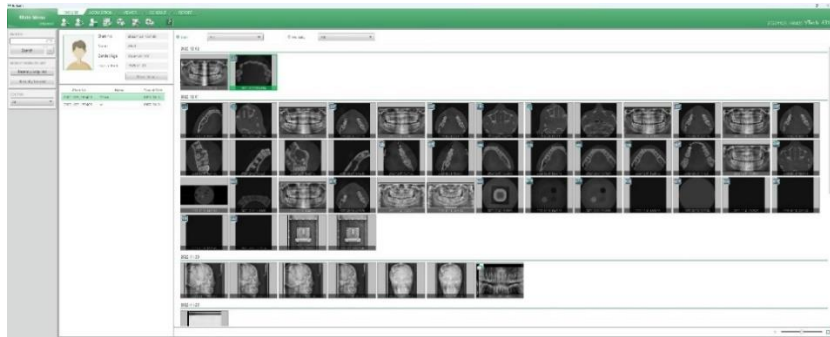

NOTICE

You can select one image at a time.

3. When you select a 3D image, the **Ez3D-i window** is open and you can view the captured images through **Ez3D-i**.

NOTICE

Check if the Ez3D-i or the 3rd party 3D viewer is linked to EzDent-i to access 3D images. Go to **EzDent-i** and select **Environment > Linkage** to check the linkage status.

10. How to Acquire 3D Model Scan Images

10.1 Program Overview

- **Role**

It provides 3D modeling surface data of the Plaster Cast. (STL file)

- **Image Acquisition Method**

It acquires images with the X-ray beam scanning the Plaster Cast and reconstructs them into 3D sliced images and converts the sliced images into 3D modeling surface data.

- **Examination Programs**

The programs are classified according to the model type.

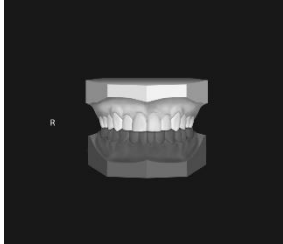
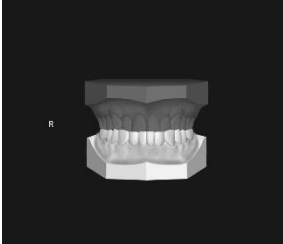
Applied FOV (cm)	Vertical Option	ROI	Description
8x8	Upper (Maxilla)		Captures a whole maxillary Plaster Cast.
	Lower (Mandible)		Captures a whole mandibular Plaster Cast.

10.2 Selecting Exposure Settings

Follow the steps below to select exposure settings for the 3D model scan.

NOTICE

You must install an STL viewer before starting a 3D model scan.

1. Open the **EzDent-i** window and select the Acquisition tab.

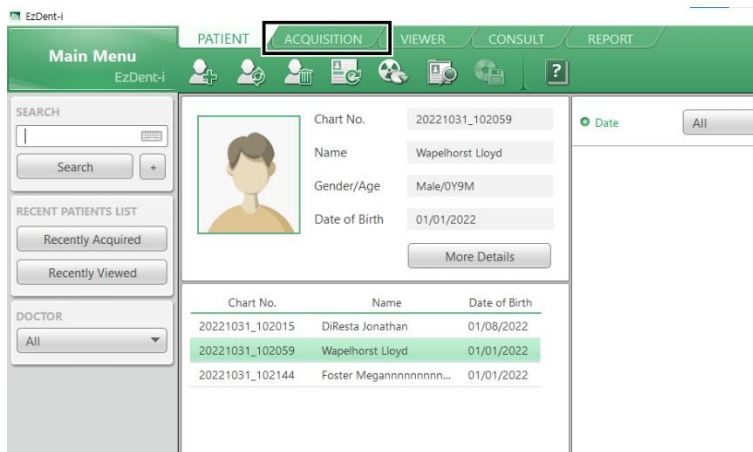

2. Select **Model** on the left menu. After selection, the main console window appears.

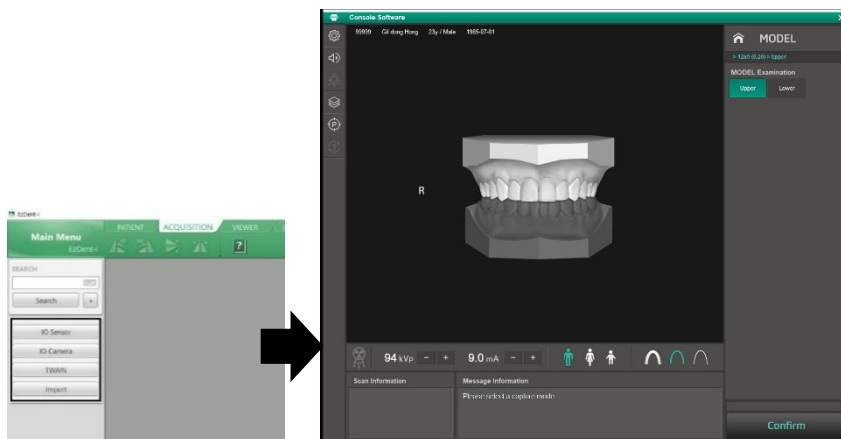

3. Select an area to acquire an image.

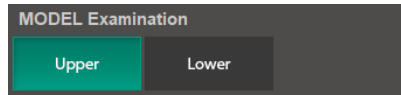

4. Once the area is selected, the system automatically sets the exposure condition. To change the condition, click the plus-minus button next to the voltage and the current symbols.

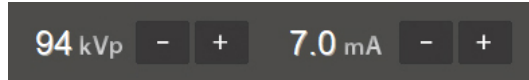

Each time you click the button, the voltage value increases by ± 1.0 kVp, and the current value by ± 0.1 mA.

Adjustable ranges for tube voltage and current are as in the table below:

Mode	Minimum Value		Maximum Value	
	kVp	mA	kVp	kVp
Model	60	4	99	12

5. Click **Confirm**. Once clicked you cannot change the selected settings and the system operates as below:



- The rotating unit moves to the scanning position.
 - The vertical beam is turned on.
 - The **scan information window** shows the estimated DAP(Dose Area Product), scan time, and exposure time.
6. Follow **10.3 Model Positioning**.

10.3 Model Positioning

Installing a Model Scan Jig

1. Remove the Temple Supports and the Chinrest
2. Insert the MODEL scan Jig.

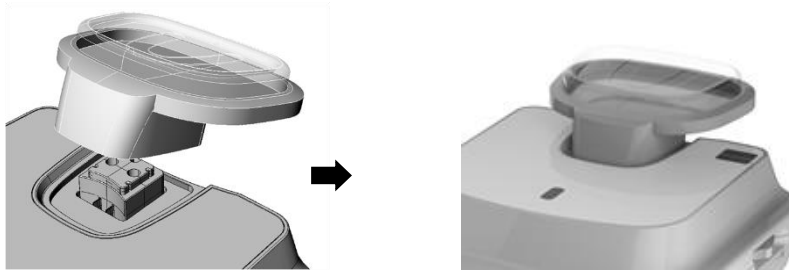

Positioning Laser Beam

1. Put the Plaster Cast on the MODEL Scan Jig. (Whether the Plaster Cast is for Maxilla or Mandibular, place it flat side down.)



2. Align the Mid-sagittal plane Laser Beam to the center of the Plaster Cast. (To prevent the horizontal expansion of the image)



10.4 Acquiring Images

Follow the steps below to acquire an X-ray image.



Do not use the PC while capturing an image. This can cause a problem with equipment or software's operation.



Release the **exposure switch** and press the **emergency stop switch** in an emergency. The equipment immediately stops its operation.



Ensure to keep communication with the patient either visually or verbally during the image capture for his or her safety.

1. Click **Ready** on the console software. X-ray emission does not start yet.



2. Press the exposure switch when the message information window says, **"Please press and hold the X-ray exposure switch until image capturing is completed."**

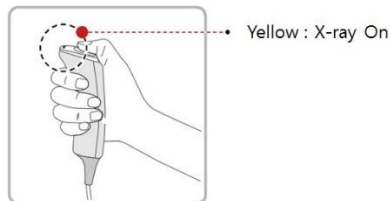

When you press the exposure switch,

- The LED on the vertical unit turns yellow.
 - The LED on the exposure switch flickers yellow.
 - The X-ray exposure status on the console software turns yellow.
3. Release the switch when you see a message on the message information window, saying **"Image capturing is complete."**

IMPORTANT

Do not release the switch until you see the message. Image acquisition can be interrupted in the middle if you release the switch before the image capture ends.

10.5 Checking the Acquired Images

Follow the steps below to check the acquired images.

1. Click **Save** to save the images you captured. You can skip this step if you select the auto-save option before scanning.
2. Open the **EzDent-i** and select the **PATIENT** tab. Select and double-click one of the images displayed next to the patient information.

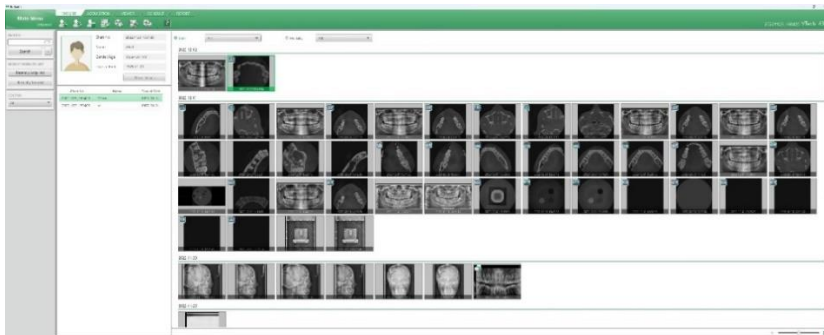

3. The STL viewer linked to the EzDent-i is open after you click the image.

NOTICE

You can select one image at a time.

NOTICE

Ensure that the STL viewer is linked to the **EzDent-i** before checking the captured images.

This Page Intentionally Left Blank

11. Troubleshooting

11.1 Troubleshooting

If a problem occurs during the operation, follow the guide in the table below to solve the issue. If the problem persists, contact VATECH customer service.

When the equipment is not working

Description	Action
Fail to turn on	Check the equipment's power connection status.
Fail to initialize	Check the error code on the console window and contact customer service.
Fail to communicate with the PC	Check the communication port (optic) that connects the PC to the equipment.

When the system cannot capture the image

Description	Action
Fail to capture an image	<ol style="list-style-type: none"> 1. Check the exposure switch's connection status. 2. Check if the console software is ready to capture an image.

When the system cannot capture the image after clicking Confirm

Description	Action
Fail to capture an image	Check the error code on the console window and contact customer service.

When the laser beam is turned off before completing patient positioning

Description	Action
Lasers are turned off	Press the Beam on/off button on the control panel.

11.2 Error Codes

When a problem occurs during the operation, an error code appears on the message information window. When you see the code, contact VATECH for assistance.

Error code is written in the following format:

[Code: **E00X.0XX.0XX**]

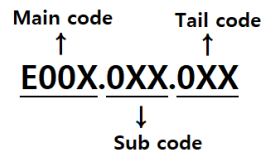

NOTICE

- **The main code** indicates the source of error codes. The source is categorized as hardware, software, an acquisition module, etc.
- **Subcode** describes the specific area where the error has occurred according to the main code.
- **The tail code** explains the specific symptoms and causes of the errors mentioned in the subcode.

11.2.1 Main Code - Hardware (001)

11.2.1.1 Subcode – Generator-Related Error (001)

Tail code	Description
001	Appears when the tube is not ready for use
002	Appears when the cable between the tube tank and Inverter board is disconnected
003	Appears when the inverter board's current exceeds the maximum allowable level during X-ray irradiation
004	Appears when there is $\pm 10\text{kV}$ or more voltage difference in tube voltage compared to a reference value
005	Appears when there is $\pm 0.5\text{mA}$ or more current difference in tube current compared to a reference value
006	Appears when there is $\pm 20\text{kV}$ or more voltage difference in tube voltage feedback compared to the average value

Tail code	Description
007	Appears when there is ± 1 mA or more current difference in tube current feedback compared to the average value
008	Appears when the temperature of the mono tank is above the setting temperature
009	Appears when the inverter output current is higher than 1A during X-ray irradiation (In EP, IP conditions)
010	Appears when the inverter board falsely recognizes the exposure switch signal as OFF after the irradiation. On command
011	Appears when the X-ray OFF command is not sent to the inverter board in 0.5 seconds after turning off the exposure switch
012	Appears when kV feedback is over -20kV compared to the setting value during X-ray irradiation
013	Appears when kV feedback is over +20kV compared to the setting value during X-ray irradiation.
014	Appears when the mA feedback value is less than 50% compared to setting conditions during X-ray irradiation.
015	Appears when the mA feedback value is higher than 150% compared to setting conditions during X-ray irradiation.

11.2.1.2 Subcode - Motor-Related Error (002)

Tail code	Description
021	Appears when rotator-axis motor origin movement fails
027	Appears when CEPH sensor motor origin movement fails
030	Appears when quadruple axis collimator left origin movement fails
031	Appears when quadruple axis collimator right origin movement fails
032	Appears when quadruple axis collimator up origin movement fails
033	Appears when quadruple axis collimator down origin movement fails

Tail code	Description
036	Appears when an error occurs during the collimator filter axis motor initialization
037	Appears when the generator tilting fails
039	Appears when X-axis motor origin movement fails
040	Appears when Y-axis motor origin movement fails

11.2.1.3 Subcode – Exposure Switch-Related Error (003)

Tail code	Description
060	It appears that the exposure switch is pressed when turning on the equipment.

11.2.1.4 Subcode – Other Errors (004)

Tail code	Description
102	Appears when there is no response during CAN communication.

11.2.2 Main Code – Software (002)

11.2.2.1 Subcode – Sequence-Related Error (001)

Tail code	Description
001	Appears when the packing mode is enabled
002	Appears when the door is open
003	Appears when the exposure switch is pressed

11.2.2.2 Subcode – PC Resolution Related Error (010)

Tail code	Description
001	Appears when the resolution is less than 1280x1024
002	Appears when the resolution is less than 1200x960

11.2.2.3 Subcode – PC Network-Related Error (024)

Tail code	Description
002	Appears when the port is invalid
003	Appears when the time is out

11.2.3 Main Code - Acquisition Module (003)

11.2.3.1 Subcode – Initialization Failure-Related Error (010)

Tail code	Description
000	Appears when the COM port cannot be opened
001	Appears when the frame grabber interface cannot be initialized, or memory for acquisition cannot be reserved
002	Appears when the MCU is not communicable, or the modem ring signal is in an improper state

11.2.3.2 Subcode – Capture Failure-Related Error (020)

Tail code	Description
000	Appears when there is a capture error

11.2.3.3 Subcode – Reconstruction Failure-Related Error (030)

Tail code	Description
001	Appears when bugs exist in the VXM file or there is insufficient memory

11.2.3.4 Subcode – Hardware-Related Error (061)

Tail code	Description
HW Error No	Appears when the error occurs during the acquisition module operation

This Page Intentionally Left Blank

12. Cleaning and Disinfection

12.1 Preparation

Before cleaning or disinfecting the equipment, you must:

- Turn off the equipment.
- Wear safety gloves.
- Select the product that satisfies the following conditions:
 - Chlorine-Dioxide based.
 - Non-alcoholic
 - Contains none of the following chemicals: silicone, acetone, phenol, acetic acid, peroxide, sodium hypochlorite, isopropyl alcohol (2-propanol, isopropanol), iodine-splitting agents, and oxygen-splitting agents.
 - Not an oil or gas type.
 - Approved by FDA and local regulations for chemical products.



Do not clean the equipment while the power is still on. This can cause electrical shock, burns, and other injuries to you or other people near the equipment.



Oil or gas-type cleaning agents can cause corrosion and deterioration.

12.2 Cleaning

Before capturing an image, clean the accessories or parts that have contact with the patient's skin. The list below shows examples of accessories and parts that require cleaning:

- Normal / Special A / Special B bite
- Temple Supports
- Chinrest
- Nasal Positioner
- Ear rods

Accessory /Part	Procedure
Bite (Normal / Special A / Special B)	1) Remove visible soil with a paper wipe or disposable cloth. 2) Use a soft cloth dampened with a cleaning agent. And gently wipe the target area with the cloth. 3) Dry the cleaned parts and accessories with a dry cloth until no liquid is left.
Temple Supports	
Chinrest	
PC and its peripherals	Clean each part following the manufacturer's instructions
Outer covers	Wipe the outer covers with a dry cloth once a day.

NOTICE

Contact **VATECH**'s customer service for more information on cleaning the equipment.

WARNING

Do not spray or pour the cleaning agent over the equipment. Liquids can damage the equipment or cause a fire.

IMPORTANT

Do not use the cloth soaked in the cleaning agent to clean the equipment. Liquids may slip into the equipment. Put a little amount of the cleaning agent on the cloth to avoid the incident for use.

12.3 Disinfection

Follow the precautions below when you choose a disinfectant and use it for the equipment.

- Use the product approved by the safety regulations of the country where the equipment is installed.
- Follow the directions on the product's label.
- Disinfect the accessories and parts that are frequently touched by people including patients.
- Do not use UV sterilizer to disinfect the equipment. UV light can discolor the equipment's surface.

This Page Intentionally Left Blank

13. Maintenance

13.1 Regular Maintenance

- **VATECH** requires periodic constancy tests to assure image quality and safety for its patients and users.
- Only **VATECH**-authorized technicians can inspect and repair the equipment. Contact the service center or your local **VATECH** representative for technical assistance.
- Users cannot inspect or repair the equipment. Contact the service center or your local **VATECH** representative for technical assistance.
- Users cannot remove the equipment's cover. There are no repairable parts inside.
- Users cannot reform or modify the equipment, cables, or wires. Modification can damage the equipment beyond repair.
- Ensure to turn off the equipment before inspection or repair.
- Ensure to inspect and repair the equipment on a flat surface.
- Do not pull cables by force.
- Ensure that the equipment is well-grounded.
- Ensure that all detachable parts are clean.
- Avoid the following places when storing the equipment or its components:
 - Susceptible to water or humidity
 - Prone to extreme fluctuation in temperature
 - Exposed to direct sunlight, salt, dust, and other pollutants.

13.2 Maintenance Task Checklist

Tasks	Period
Ensure that the equipment is clean and ready for use before the operation.	Daily
Ensure that all parts directly contacting the patients are clean.	Daily
Ensure that the main power switch is turned off after the operation.	Daily
Check for the temperature of the power cords.	Daily
Ensure that the LED indicator turns yellow when you press the exposure switch .	Daily
Ensure that the LED indicator remains yellow during the operation.	Daily
Check for defects on the cables inside and outside the equipment.	Daily
Check the correct operation of the emergency stop switch	Weekly
Ensure that all labels on the equipment are intact and legible.	Weekly
Check the condition of the exposure switch .	Monthly
Check the sound of the audio messages from the equipment.	Monthly

13.3 QA Test

This section intends to give users information about the PHT-75CHS phantom kit for 3D image quality inspection and calibration. Ensure to read this section to conduct a regular QA test with the phantom kit.

The **QA test** must be carried out annually at the period specified by the manufacturer or the law of the state where the X-ray system is installed.

13.4 Phantom Kit Contents

- CT Number Check Phantom x 1
- Uniformity Check Phantom x1
- S&C Check Phantom x1
- Phantom Jig A'ssy x 1
- Phantom Kit User Manual I x 1

13.4.1 Specifications of Phantom Kit Contents

CT Number Check Phantom

- Manufacturer
VATECH Co., Ltd.
- Intended Use
 - CT Number Inspection
 - CT Number Calibration
- Complies with
 - IEC 61223-2-6
 - IEC 61223-3-5

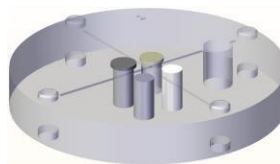

Uniformity Check Phantom

- Manufacturer
VATECH Co., Ltd.
- Intended Use
 - CT Image Homogeneity Inspection
 - CT Image Noise Inspection
- Complies with
 - IEC 61223-2-6
 - IEC 61223-3-5

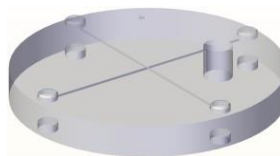

S&C Check Phantom

- Manufacturer
VATECH Co., Ltd.
- Intended Use
 - Low Contrast Resolution Inspection
 - High Contrast Resolution Inspection
- Complies with
 - IEC 61223-2-6
 - IEC 61223-3-5

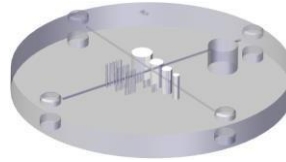

Phantom Jig Assembly

- Manufacturer
VATECH Co., Ltd.
- Intended Use
 - CT Image Inspection
 - CT Image Calibration

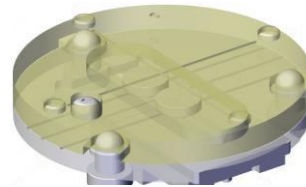

13.5 QA Test Procedure

- Each facility shall establish a committee of individuals to be responsible for the Radiation Safety/Quality Assurance program. For a non-hospital facility, this committee might be composed of a dentist, an X-ray technician, an office manager, and a service representative who is certified to perform radiological functions by the law in the state in which the X-ray system is being used.
- Each facility shall make the radiation safety/quality assurance program, including the following tests, at the frequency specified by the manufacturer or state regulations and maintain records of the data.
- For technical assistance for QA tests, contact your local VATECH service representative.
- If the test criteria are not met, contact your local VATECH service representative.

13.5.1 QA CT Number Test

Follow the CT Number Test procedure below to produce correct images and analyze the User Phantom. Test results must be documented and maintained for at least one year. The CT number for water should be recorded and compared each day to the established specifications.

13.5.1.1 Setting up CT Number Phantom

Follow the step below to set a CT number Phantom.

1. Remove the **bite block** and the **temple supports** from the unit.
2. Align the **phantom fixing bolts** to the **bottom phantom jig's baseline** as below and turn the bolts clockwise to tighten them.

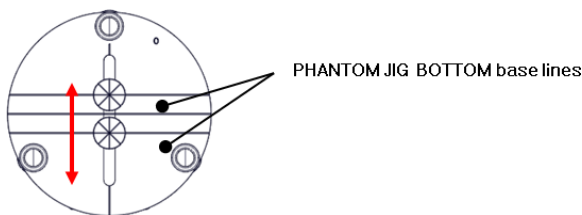

3. Insert the **bottom phantom jig** into the chinrest. Then place the top phantom jig over the inserted phantom.

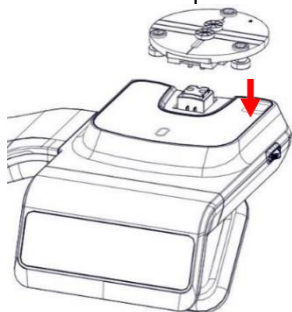

4. Place the phantom jig ass'y top on the phantom jig ass'y bottom as shown below.

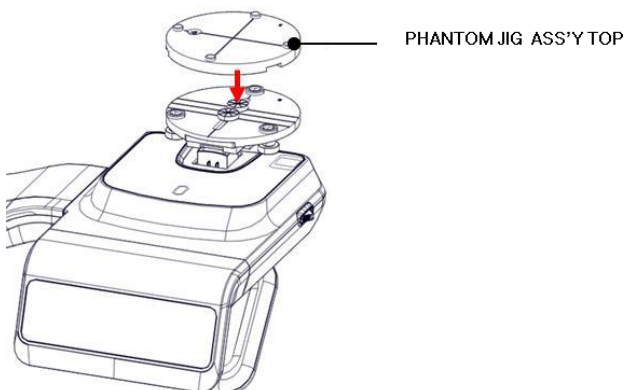

5. Make the **phantom jig ass'y** level by using a bubble level and three align pins.

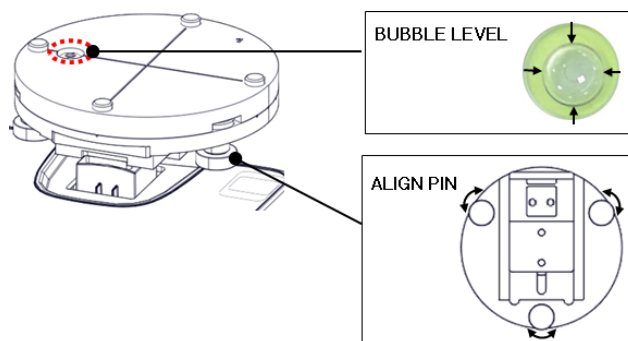

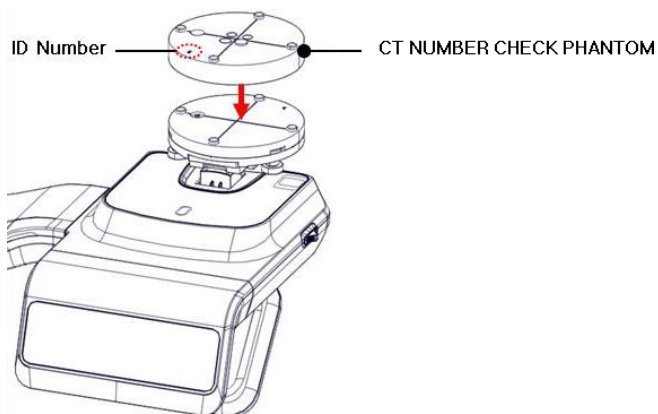

6. Place a CT number check phantom on the phantom jig ass'y.



7. Run the 2D viewer and click to add a patient for the QA test.



13.5.1.2 Imaging CT Number Phantom

To capture an image with the CT number phantom:

1. Click  to run Capture Software in EzDent-i.
2. Click  to enter Phantom Capture mode.
3. Click the **CT** check box and click **Capture**.
4. Click the **NEXT** button at the bottom of the Capture Software screen.
5. Click the **READY** button when enabled.
6. Capture the PHANTOM image according to capture software instructions.
7. When the image capturing is completed, save the image in EzDent-i.

13.5.1.3 Analyzing CT Number Phantom

To analyze the test with the CT number phantom:

1. Double-click the saved PHANTOM image in EzDent-i to run Ez3D-I Plus.
2. In the Axial pane, click  in the upper-right corner to maximize the Axial view.
3. Click  >  Rectangle .

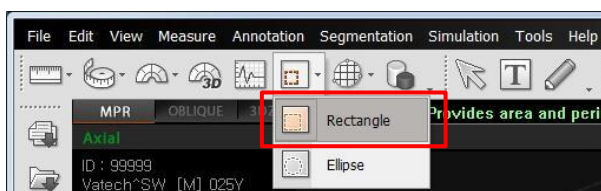

4. Make the boxes on the WATER, TEFLON, and AIR area as shown below.

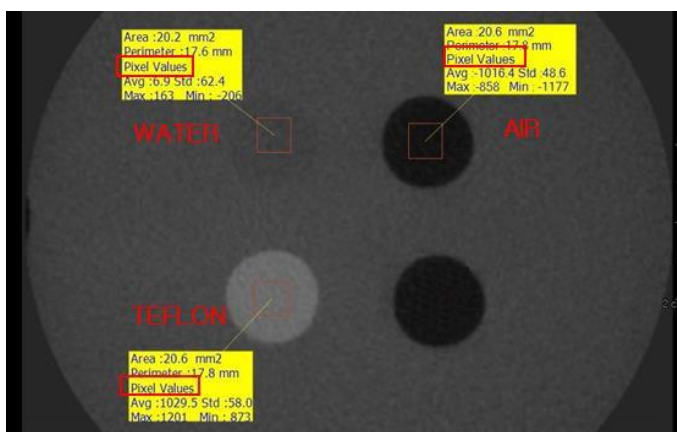



NOTICE

Try to make each box as close to 20.0 mm² in the area as possible.

- Compare the CT NUMBER average values from the WATER, TEFLON, and AIR areas with the standard.

MATERIAL	MEAN	LOWER LIMIT	UPPER LIMIT	Scope
AIR	-990 HU	-1030 HU	-900 HU	IEC 61223-2-6: 5.5.4, 5.5.5
WATER	0 HU	-50 HU	50 HU	
TEFLON	980 HU	900 HU	1100 HU	

- Record the mean CT Number value of each material.

- Click  >  Full screen... and save the captured screen in EzDent-i.

- Remove User Phantom from the PHANTOM JIG ASS'Y.

13.5.2 QA CT Uniformity Test



Follow the step below to perform a CT uniformity test. Test results must be documented and maintained for at least one year.

13.5.2.1 Testing with a CT Uniformity Check Phantom

Follow the step below to capture an image with a **CT uniform check phantom**.

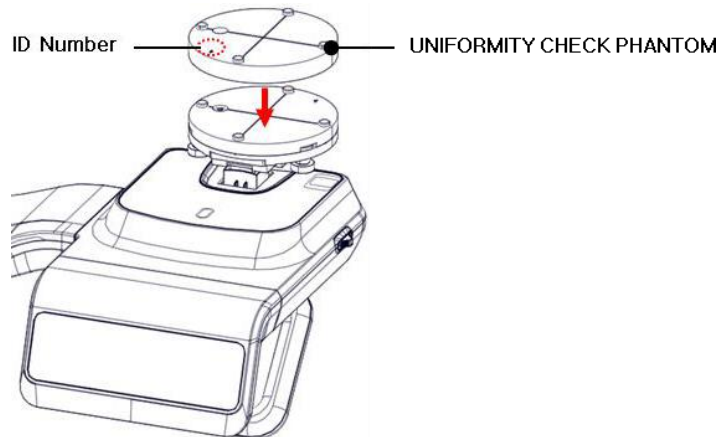
1. Remove the bite block and the temple support from the chinrest.
2. Insert the **bottom phantom jig** on the chinrest. Then place the **top phantom jig** over the bottom phantom jig.
3. Make the phantom jig ass'y level by using the bubble level and three align pins.
4. Put a **uniformity check phantom** on the phantom jig ass'y.



5. Click  to run capture software from the EzDent-i.
6. Click  to enter **Phantom Capture mode**.
7. Check on the CT box and click **Capture**.
8. Click **Next** at the bottom of the capture software window.
9. Click **Ready** when enabled.
10. Capture the PHANTOM image following the software's instructions.
11. When the image capture is finished, save the image in the **EzDent-i**.

13.5.2.2 Analyzing CT Uniformity Check Phantom

Follow the steps below to analyze the result of the CT uniformity test:

1. Double-click the saved phantom image in the **EzDent-i**. The **Ez3D-i** widow opens after clicking the image.
2. In the Axial pane, click  in the upper-right corner to maximize the Axial view.

3. Click  > .

4. Make 25 mm lines from the center to the up/down /left/right directions as shown below.

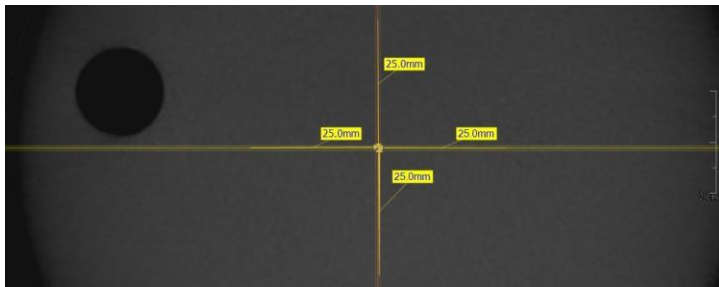

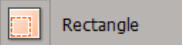
5. Click  >  Rectangle.

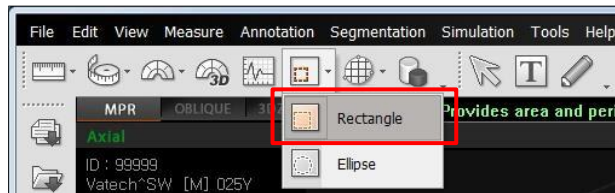

6. Make the four boxes next to each 25mm line, as shown below.

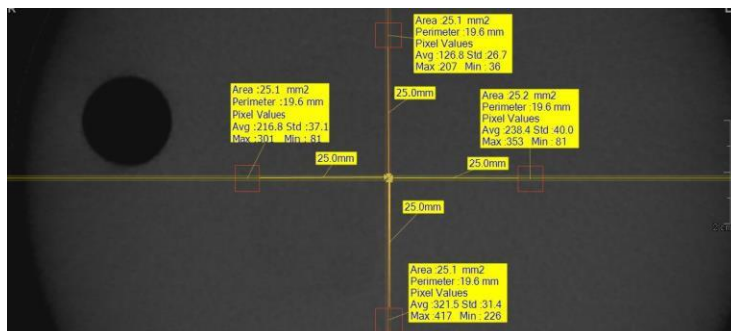

- 1) Try to make each box as close to 25.0 mm² in the area as possible.
 - 2) Put the 4 ROIs at the end of each 25.0 mm line
7. Measure the homogeneity by calculating the difference between the maximum and minimum average values among the 4 ROIs and compare the homogeneity with its standard.

Calculation	Standard	Scope
Subtract the minimum average value from the Maximum average value among the 4 ROIs	The difference should be less than 400 HU	61223.35 INTRODUCTION

8. Record the mean CT Number value of each material.

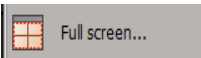
9. Click  >  and save the captured screen in **EzDent-i**.

10. When finished, exit **EzDent-i**

13.5.3 High and Low Contrast Resolution Tests

Perform a high/low contrast resolution test at the following interval:



- High contrast resolution test: Initially and Yearly
- Low contrast resolution test: Initially and Yearly

13.5.3.1 Imaging S&C Check Phantom

To perform a high and low contrast resolution with S&C check phantom:

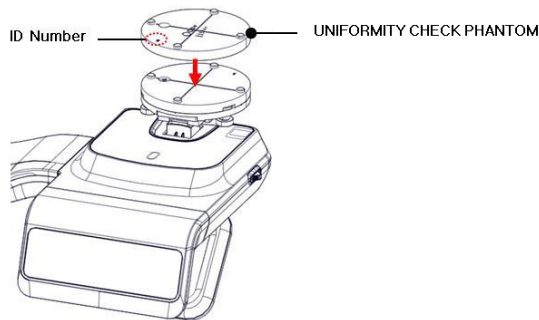

1. Remove the bite and the temple support from the unit.
2. Insert the **bottom phantom jig** into the chinrest
3. Place the **top phantom jig** over the phantom jig bottom.
4. Make the phantom jig ass'y level by using the bubble level and three align pins.
5. Put **S&C check phantom** on the **phantom jig ass'y**.



6. Click  to start the 2D viewer.
7. Click  to enter the **phantom capture mode**.
8. Check the **CT box** and click **Capture**.
9. Click **Next** at the bottom of the capture software window.
10. Click **Ready** after the button is enabled on the window.
11. Follow the capture software's instructions to capture the phantom image.
12. Save the captured image on EzDent-i after taking the image.

13.5.3.2 Analyzing S&C Check Phantom

To analyze the test with an S&C check phantom:

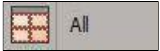
1. Remove the bite and temple support from the unit.
2. Double-click the saved phantom image in EzDent-i to run Ez3D-i.
3. Go to the Axial view and click  for full-screen mode.
4. Click  and  to adjust the brightness and contrast in the saved image. Drag the icon left and right to change the contrast or up and down to adjust the brightness.
5. Make sure that you can see the minimum size of the Airhole and the PE (Polyethylene) cylinder at 50 cm (20 ") from the monitor.

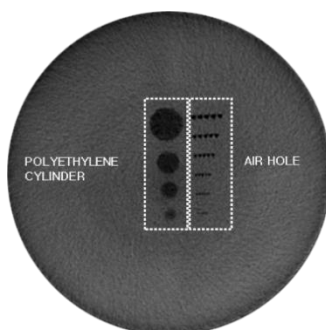

Parameters	Material	Minimum visible size (mm)
High Contrast Resolution	Air Hole	1.0
Low Contrast Resolution	PE cylinder	8.0

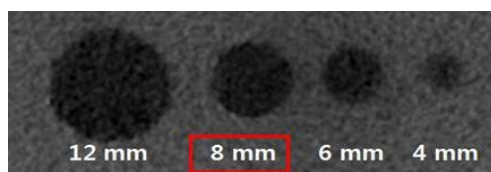

<High Contrast Resolution>

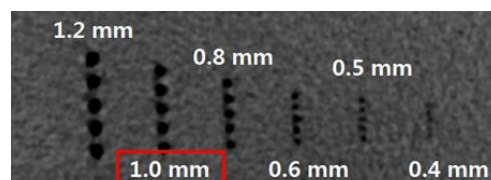

<Low Contrast Resolution>

This Page Intentionally Left Blank

14. Disposing of the Equipment

To reduce environmental contamination, this equipment is designed for safe use and disposal. Many components, except for the parts like the X-ray tube, are environmentally friendly and recyclable.

All parts and components that contain hazardous materials must be disposed of by disposal regulations (IEC 60601-1 6.8.2 j).

Parts	Materials	Recyclable	To the special disposal site	Hazardous waste; Needs Separate Collection
Frame and covers	Aluminum and plastics	•		
Motors		•		
Circuit boards		•		
Cables and transformer	Copper	•		
	Steel	•		
	Oil		•	
Packing	Wood	•		
	Cardboard	•		
	Paper	•		
X-ray tube				•
Sensor head	Return the sensor head to VATECH			
Other parts			•	



This dental equipment shall not be disposed of as domestic garbage materials.

IMPORTANT

Clean/Disinfect/Sterilize the equipment before disassembling it and disposing of its parts.

NOTICE

Observe all regulations relevant to the disposal of waste in your country.

This Page Intentionally Left Blank

15. Technical Specifications

	With CEPH	Without CEPH
Top view (Without Base)		
Front View (Without Base)		

Item		Description
Weight	Without CEPH unit	162.9 kg (359.13 lbs. - without Base)
		217.9 kg (480.38 lbs. – with Base)
	With CEPH unit	187.9 kg (414.25 lbs. - without Base)
		242.9 kg (535.50 lbs. - with Base)
Total Height	Without Base	Max. 2317.4 mm (91.24")
	With Base	Max. 2345.4 mm (92.34")
Dimensions during operation (Length x Width x Height)	Without CEPH unit	without Base: 1085.0(L) x 1457.8(W) x 2317.4(H) (mm) 42.72(L) x 57.39 (W) x 91.24(H) (")
		with Base: 1085.0(L) x 1457.8(W) x 2345.4(H) (mm) 42.72(L) x 57.39 (W) x 92.34(H) (")
	With CEPH unit	without Base: 1905.5(L) x 1457.8 (W) x 2317.4(H) (mm) 75.02(L) x 57.39 (W) x 91.24(H) (")
		with Base: 1905.5(L) x 1457.8 (W) x 2345.4 (H) (mm) 75.02(L) x 57.39 (W) x 92.34(H) (")
Rotating Unit Vertical Movement		Max. 800 mm (31.50")
Installation type		Base Stand / Wall Mount (Default: Wall Mount type)
Packing Box Organization		Main Box, CEPH Box (Optional), Base Box (Optional)

15.1.2 Image Magnification

Mode	FDD (mm)	FOD (mm)	ODD (mm)	Magnification
PANO	560	414.81	145.19	1: 1.35
CEPH	1745	1524.00	221.00	1: 1.14
CBCT	560	350.00	210.00	1: 1.60

- **FDD:** Focal Spot to Detector Distance
- **FOD:** Focal Spot to Object Distance
- **ODD:** Object to Detector Distance (ODD = FDD - FOD)
- **Magnification** = FDD/FOD

15.2 Technical Specifications

15.2.1 X-ray Generator Specifications

Specifications

Item		Description	
Generator	Model	DG-07E22T2	
	Rated output power	1.6 kW	
	Inverter model name	INV-22	
	Type	Inverter	
	Normal/ Pulse	kVp	60 kV~99 kV (1 kV increment)
		mA	4 mA~16 mA CBCT: 0.1 mA increment PANO and CEPH: 1 mA increment
	Cooling	Thermals protect	
	Total filtration	Min. 2.5 mm Al	
	Permanent filtration	Min. 1.0 mm Al	
	Added filter		PANO and CEPH: 1.5 mm Al (Fixed)
		CBCT: 1.5 mm Al (Fixed) + 3.0 mm Al (Automatically added)	
Tube	Manufacturer	Canon Electron Tubes & Devices	
	Model	D-052SB (Stationary Anode type)	
	Focal spot size	0.5 mm (IEC 60336)	
	Target Angle	5 degrees	
	Permanent filtration	At least 0.8 mm Al equivalent at 50kV	
	X-ray Coverage	95 mm x 380 mm at SID 550 mm	
	Anode Heat Content	35 kJ	
	Duty Cycle	1:60 or more (Exposure time: Interval time)	

Test Condition

Mode	Tube Voltage (kVp)	Tube Current (mA)	Exposure Time (s)
PANO	60~90	4~14	13.5
	60~90	4~14	11.5
	60~90	4~14	11.2
	60~90	4~14	9.2
	60~90	4~14	9.0
	60~90	4~14	8.0
	60~90	4~14	6.8
	60~90	4~14	6.7
	60~90	4~14	6.7
	60~90	4~14	6.2
	60~90	4~14	5.7
	60~90	4~14	5.5
	60~90	4~14	4.5
	60~90	4~14	3.9
	60~90	4~14	3.7
	60~90	4~14	3.4
	60~90	4~14	3.2
	60~90	4~14	3.0
	60~90	4~14	2.8
	60~90	4~14	2.0
60~90	4~14	1.5	
60~90	4~14	0.8	
CEPH	60~99	4~16	1.9
	60~99	4~15	2.4
	60~99	4~15	3.9
	60~99	4~14	4.9
	60~99	4~14	5.4
CBCT	60~99	4~12	16.9
	60~99	4~12	13.5
	60~99	4~12	11.4
	60~99	4~12	9.0

Maximum Rating Charts

Constant potential high-voltage generator
Nominal Focus Spot Value: 0.5

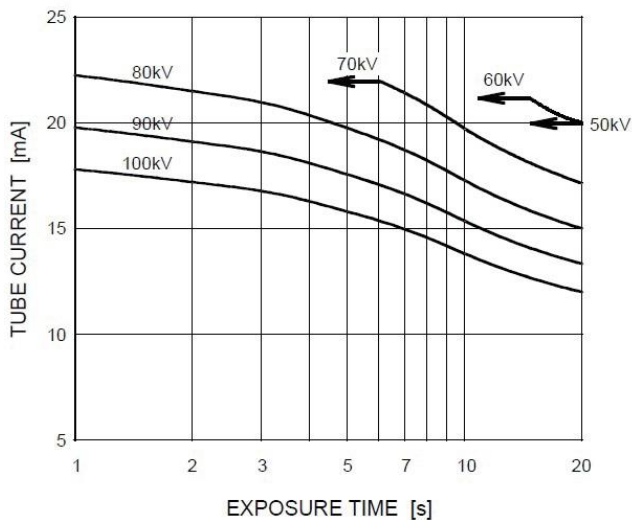

Emission & Filament Characteristics

Constant potential high-voltage generator
Nominal Focus Spot Value: 0.5

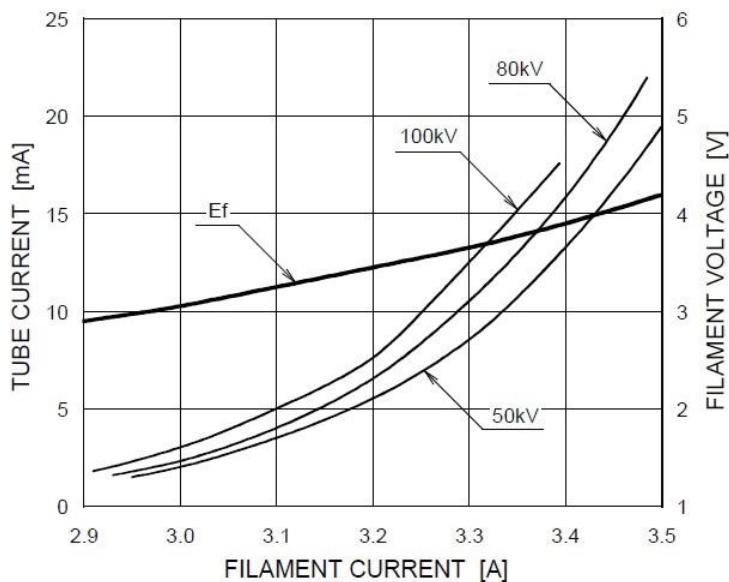

■ ■ Anode Thermal Characteristics

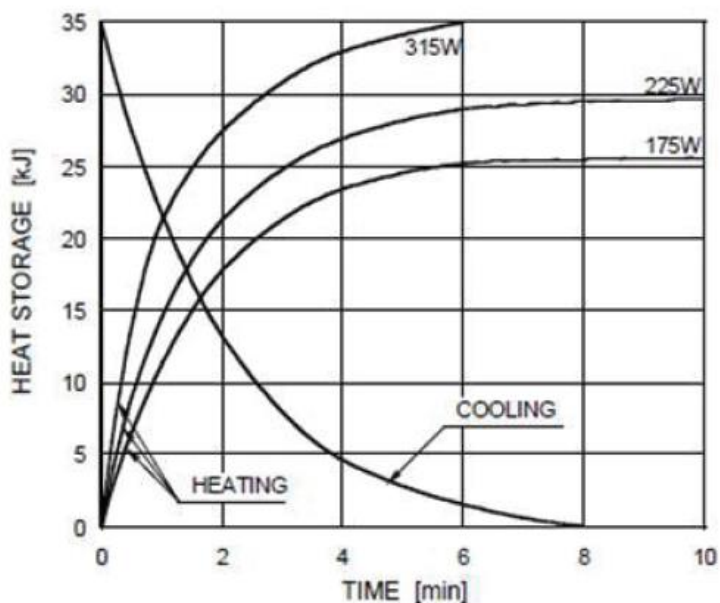

■ ■ X-ray Housing Assembly Tube Characteristics

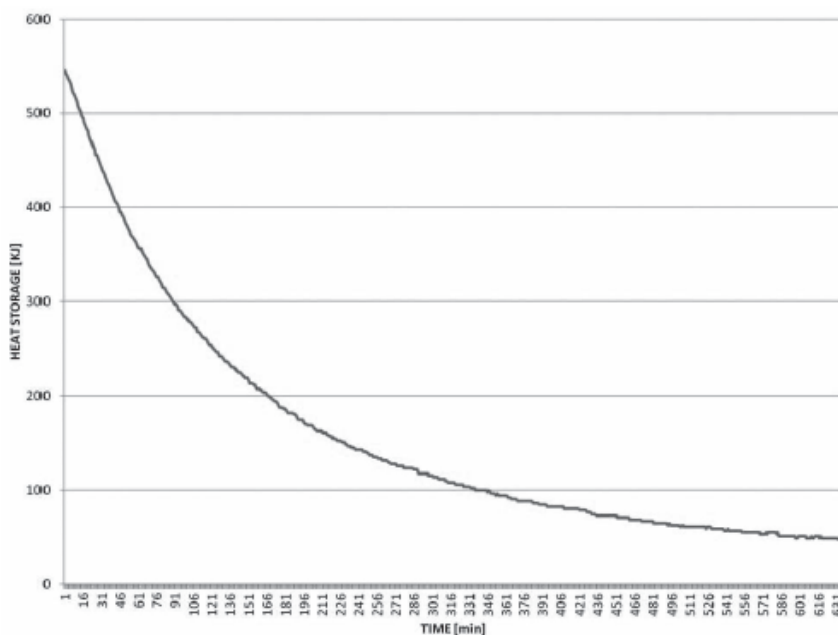

15.2.2 Detector Specifications

Item	Description	
	PANO & CBCT	CEPH
Model	Xmaru1404CF-Plus	Xmaru2602CF
Detector Type	CMOS photodiode array	
Pixel Size	99 μm @ 2x2 binning 198 μm @ 4x4 binning	200 μm @ 2x2 binning
Active Area	PANO: 135.8 X 5.9 (mm) CBCT: 135.8 X 36.4 (mm)	259.20 x 15.60 (mm)
Frame Rate	~ 107 fps @ 2x2 binning ~ 308 fps @ 4x4 binning	~ 320 fps @ 2x2 binning
Analogue-Digital Conversion	14 bit	
Operating Condition	10~35 °C (Temperature) 10~75 % (Humidity)	
Storage Condition	-10~60 °C (Temperature) 10~75 % (Humidity)	
Sensor Size	165 (L) x 230 (W) x 26(H) (mm)	110 (L) x 279 (W) x 20 (H) (mm)
Sensor Weight	1.6 kg	<1.0 kg
Converter	Csl : TI	
Energy Range	40~120 kVp	
Readout	Charge amplifier array	
Video Output	Optic	
MTF	$\geq 50\%$ @ 1.0 lp/mm @2x2 binning $\geq 45\%$ @ 1.0 lp/mm @4x4 binning	$\geq 2\%$ @ 2.5 lp/mm
Dynamic Range	> 78 dB @ 2X2 binning > 80 dB @ 4X4 binning	≥ 68 dB

15.3 Electrical Specifications

Item	Description
Power supply voltage	100-240 V~
Frequency	50 / 60 Hz
Power Rating	2.2 kVA
Accuracy	Tube Voltage (kVp) $\pm 10\%$, Tube Current (mA) $\pm 20\%$, Exposure Time (s) $\pm (5\% + 50\text{ ms})$

- The input line voltage depends on the local electrical distribution system.
- Allowable input voltage fluctuation requirement: $\pm 10\%$.
- **Mode of operation:** non-continuous operation (NFPA 70: long time operation) - needs waiting time (at least 60 times the exposure time) before the next exposure begins.
- Column operation time: Max. 2 min. On/18 min. Off (Ratio 1:9)

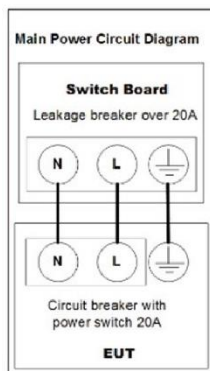
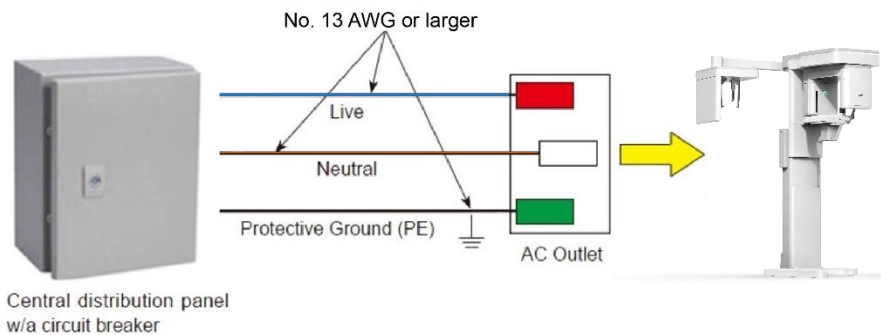

NOTICE

- To assure line voltage quality, a separate 3-core grounded power cable connected directly to the central distribution panel with an over-current circuit breaker rated for 20A must be used.
- Maximally allowed deviation of the tube voltage/tube current/exposure time:
 Tube Voltage (kVp) $\pm 10\%$ / Tube Current (mA) $\pm 20\%$ / Exposure Time (s) $\pm (5\% + 50\text{ ms})$ according to IEC 60601-2-63.
- The mains resistance should not exceed 0.045 ohms at 100 V and 0.19 ohm at 240 V.

15.4 Environmental Specifications

Item		Description
During Operation	Temperature	10~35 °C
	Relative humidity	30~75 %
	Atmospheric pressure	860~1060 hPa
During Transport and Storage	Temperature	-10~60 °C
	Relative humidity	10~75 %
	Atmospheric pressure	860~1060 hPa

This Page Intentionally Left Blank

16. Appendices

16.1 Recommended X-ray Exposure Tables

16.1.1 PANO Mode

Scan / Exposure Time

Mode	Arch Selection	PANO Examination	High Resolution		Green	
			Scan Time(s)	Exposure Time(s)	Scan Time(s)	Exposure Time(s)
PANO	Narrow	Standard	14.1	13.5	7.5	7.3
		Right	14.1	6.7	7.5	3.7
		Front	14.1	11.2	7.5	5.9
		Left	14.1	6.7	7.5	3.7
	Normal	Standard	14.1	13.5	7.5	7.3
		Right	14.1	6.7	7.5	3.7
		Front	14.1	11.2	7.5	5.9
		Left	14.1	6.7	7.5	3.7
	Wide	Standard	14.1	13.5	7.5	7.3
		Right	14.1	6.7	7.5	3.7
		Front	14.1	11.2	7.5	5.9
		Left	14.1	6.7	7.5	3.7
	Child	Standard	12.0	11.5	5.9	5.6
		Right	12.0	5.7	5.9	2.8
		Front	12.0	9.2	5.9	4.5
		Left	12.0	5.7	5.9	2.8
	Orthogonal	Standard	14.1	13.5	7.5	7.3
		Right	14.1	6.7	7.5	3.7
		Front	14.1	11.2	7.5	5.9
		Left	14.1	6.7	7.5	3.7
Bitewings		14.1	9.0	7.5	5.2	
Bitewing Incisor		14.1	2.8	7.5	1.4	

Mode	Arch Selection	PANO Examination	High Resolution		Green	
			Scan Time(s)	Exposure Time(s)	Scan Time(s)	Exposure Time(s)
		Bitewing Right	14.1	4.5	7.5	2.6
		Bitewing Left	14.1	4.5	7.5	2.6
SPECIAL	-	TMJ LAT Open	14.1	6.7	n/a	n/a
		TMJ LAT Close				
		TMJ PA Open	10.0	6.1	n/a	n/a
		TMJ PA Close				
		Sinus LAT	4.0	3.7	n/a	n/a
		Sinus PA	8.8	8.0	n/a	n/a

*Green, Insight PAN, Bitewing Incisor, TMJ PA open/close, and Sinus LAT are optional in some countries.

- **Scan Time:** The actual time that the equipment shoots the patient except for the initial acceleration and late deceleration stages.
- **Exposure Time:** The actual time that the patient is exposed to the X-ray emission.

Exposure Time – Insight PAN

Mode	Patient group	Condition	Exposure Time(s)
Insight PAN	Man	Default	7.5
		Min.	2.1
		Max.	10.9
	Woman	Default	7.5
		Min.	2.1
		Max.	10.9
	Child	Default	5
		Min.	2.4
		Max.	8.2

- The exposure time of Insight PAN is adjusted automatically depending on the selected exposure area.

Exposure Condition

Mode	Image Option	Patient group	X-ray Intensity	Tube Voltage (kVp)	Tube Current (mA)
PANO (Standard, Right, Left, Front)	High Resolution	Man	Hard	75	10
			Normal	74	10
			Soft	73	10
		Woman	Hard	74	10
			Normal	73	10
			Soft	72	10
		Child	Hard	70	8
			Normal	69	8
			Soft	68	8
	Green	Man	Hard	76	9
			Normal	75	9
			Soft	74	9
		Woman	Hard	75	9
			Normal	74	9
			Soft	73	9
		Child	Hard	71	12
			Normal	70	12
			Soft	69	12
PANO (Bitewings, Bitewing Right, Bitewing Left, Bitewing Incisor)	High Resolution	Man	Hard	75	10
			Normal	74	10
			Soft	73	10
		Woman	Hard	74	10
			Normal	73	10
			Soft	72	10
		Child	Hard	70	8
			Normal	69	8
			Soft	68	8
	Green	Man	Hard	76	9
			Normal	75	9
			Soft	74	9

Mode	Image Option	Patient group	X-ray Intensity	Tube Voltage (kVp)	Tube Current (mA)
		Woman	Hard	75	9
			Normal	74	9
			Soft	73	9
		Child	Hard	70	8
			Normal	69	8
			Soft	68	8
PANO (Insight PAN; Optional)	N/A	Man	Normal	70	6
		Woman	Normal	69	6
		Child	Normal	67	6
Special	N/A	Man	Hard	75	10
			Normal	74	10
			Soft	73	10
		Woman	Hard	74	10
			Normal	73	10
			Soft	72	10
		Child	Hard	70	8
			Normal	69	8
			Soft	68	8

16.1.2 CEPH Mode

Exposure Condition

Mode	Image Option	Patient group	X-ray Intensity	Tube Voltage (kVp)	Tube Current (mA)
Lateral	High Resolution	Man	Hard	92	15.0
			Normal	90	15.0
			Soft	88	15.0
		Woman	Hard	90	15.0
			Normal	88	15.0
			Soft	86	15.0
		Child	Hard	88	15.0
			Normal	86	15.0
			Soft	84	15.0
	Green	Man	Hard	92	16.0
			Normal	90	16.0
			Soft	88	16.0
		Woman	Hard	90	16.0
			Normal	88	16.0
			Soft	86	16.0
Child		Hard	88	16.0	
		Normal	86	16.0	
		Soft	84	16.0	
Full Lateral (Option)	High Resolution / Green	Man	Hard	92	14.0
			Normal	90	14.0
			Soft	88	14.0
		Woman	Hard	90	14.0
			Normal	88	14.0
			Soft	86	14.0
		Child	Hard	88	14.0
			Normal	86	14.0
			Soft	84	14.0
		Man	Hard	92	14.0

Mode	Image Option	Patient group	X-ray Intensity	Tube Voltage (kVp)	Tube Current (mA)
PA SMV Waters' view	High Resolution		Normal	90	14.0
			Soft	88	14.0
			Hard	90	14.0
		Woman	Normal	88	14.0
			Soft	86	14.0
			Hard	88	14.0
		Child	Normal	86	14.0
			Soft	84	14.0
			Hard	88	14.0
	Green	Man	Hard	92	15.0
			Normal	90	15.0
			Soft	88	15.0
		Woman	Hard	90	15.0
			Normal	88	15.0
			Soft	86	15.0
		Child	Hard	88	15.0
			Normal	86	15.0
			Soft	84	15.0
Carpus	High Resolution / Green	Man	Hard	90	6.0
			Normal	88	6.0
			Soft	86	6.0
		Woman	Hard	88	6.0
			Normal	86	6.0
			Soft	84	6.0
		Child	Hard	86	6.0
			Normal	84	6.0
			Soft	82	6.0

Scan / Exposure Time

CEPH Examination	Image Option			
	High Resolution		Green	
	Scan Time (s)	Exposure Time (s)	Scan Time (s)	Exposure Time (s)
Lateral	3.9	3.9	1.9	1.9
Full Lateral (Optional)	5.4	5.4	3.9	3.9
PA	4.9	4.9	2.4	2.4
SMV	4.9	4.9	2.4	2.4
Waters' view	4.9	4.9	2.4	2.4
Carpus	4.9	4.9	2.4	2.4

- **Scan Time:** The actual time that the equipment shoots the patient except for the initial acceleration and late deceleration stages.
- **Exposure Time:** The actual time that the patient is exposed to the X-ray emission.

16.1.3 CBCT Mode

Exposure Area

FOV (cm)	Vertical Position	Horizontal Position		
		Right	Center	Left
Double Scan	Maxilla	X	O	X
	Mandible	X	O	X
12x8.5	Occlusion	X	O	X
	TMJ	O	X	O
	Sinus	X	O	X
8x8	Occlusion	O	O	O
8x5	Maxilla	O	O	O
	Mandible	O	O	O
Smart Focus	Maxilla	Selectable FOV by Teeth (Unlimited)		
	Mandible			
Endo	Maxilla	Selectable FOV by Teeth (Total: 32)		
	Mandible			

Exposure Condition

FOV (cm)	Image Option	Patient Group	X-ray Intensity	Tube Voltage (kVp)	Tube Current (mA)
Double Scan Smart Focus 12x8.5 8x8 8x5	High Resolution	Man	Hard	95	12.0
			Normal	94	12.0
			Soft	93	12.0
		Woman	Hard	95	11.7
			Normal	94	11.7
			Soft	93	11.7
		Child	Hard	95	11.4
			Normal	94	11.4
			Soft	93	11.4
	Green	Man	Hard	88	7.0
			Normal	87	7.0
			Soft	86	7.0
		Woman	Hard	88	6.7
			Normal	87	6.7
			Soft	86	6.7
		Child	Hard	88	6.4
			Normal	87	6.4
			Soft	86	6.4
Endo	High Resolution	Man	Hard	95	12.0
			Normal	94	12.0
			Soft	93	12.0
		Woman	Hard	95	11.7
			Normal	94	11.7
			Soft	93	11.7
		Child	Hard	95	11.4
			Normal	94	11.4
			Soft	93	11.4
	Green	Man	Hard	88	10.0
			Normal	87	10.0
			Soft	86	10.0

FOV (cm)	Image Option	Patient Group	X-ray Intensity	Tube Voltage (kVp)	Tube Current (mA)
		Woman	Hard	88	9.7
			Normal	87	9.7
			Soft	86	9.7
		Child	Hard	88	9.4
			Normal	87	9.4
			Soft	86	9.4
Scout	High Resolution	Man	Hard	95	9.0
			Normal	94	9.0
			Soft	93	9.0
		Woman	Hard	95	8.7
			Normal	94	8.7
			Soft	93	8.7
		Child	Hard	95	8.4
			Normal	94	8.4
			Soft	93	8.4
	Green	Man	Hard	88	7.0
			Normal	87	7.0
			Soft	86	7.0
		Woman	Hard	88	6.7
			Normal	87	6.7
			Soft	86	6.7
Child		Hard	88	6.4	
		Normal	87	6.4	
		Soft	86	6.4	

Scan / Exposure Time

FOV (cm)	Scan Time (s) (High Resolution / Green)		Exposure Time (s) (High Resolution / Green)	
	Scout	8x5	14.5	8x5
Endo		14.5	Endo	6.2
Endo	13.0		11.4	
8x5	10.0		9.0	
8x8	10.0		9.0	
Double Scan Mandible (Auto PANO off)	15.5		13.5	
Double Scan Mandible (Auto PANO on)	19.9		16.9	
Double Scan Maxilla (Auto PANO on)	19.9		16.9	
Double Scan Maxilla (Auto PANO off)	15.5		13.5	
Smart Focus (Auto PANO on)	19.9		16.9	
Smart Focus (Auto PANO off)	15.5		13.5	
12x8.5 (Auto PANO on)	19.9		16.9	
12x8.5 (Auto PANO off)	15.5		13.5	

- **Scan time:** the actual time that the equipment shoots the patient except for the initial acceleration and late deceleration stages.
- **Exposure time:** the actual time that the patient is exposed to the X-ray emission.
- **The full arch** option does not affect the system's scan time and exposure time.

Scan Pattern

No.	FOV (cm)	Exposure Time (sec per rotation)		Number of Rotations		Exposure off time (sec per off time)	Number of off times
1	Endo	5.7		2		1.6	1
2	8x5	4.5		2		1.0	1
3	8x8	4.5		2		1.0	1
4	12x8.5 (Auto PANO Off)	4.5		3		1.0	2
5	Smart focus (Auto PANO Off)	4.5		3		1.0	2
6	Double Scan (Auto PANO Off)	4.5		3		1.0	2
7	12x8.5 (Auto PANO On)	4.5	3.4	3	1	1.0	3
8	Smart focus (Auto PANO On)	4.5	3.4	3	1	1.0	3
9	Double Scan (Auto PANO On)	3.4	3.4	3	1	1.0	3

- **Exposure time** = (Exposure time per rotation) x (Number of rotations)
- **Scan time** = (Exposure time)+(Exposure-off time x Number of off-times)
- **The Exposure time of Auto Pano per rotation** = 3.4 secs.
- **Note:** In double scan mode, the system captures images twice following the scan pattern

16.1.4 3D MODEL Scan Mode

Exposure Area

FOV (cm)	Vertical Position	Horizontal Position		
		Right	Center	Left
8x8	Maxilla	X	O	X
	Mandible	X	O	X

Scan / Exposure Time

FOV (cm)	Scan Time (s)	Exposure Time (s)
8x8	10.0	9.1

Exposure Condition

FOV (cm)	Patient Group	X-ray Intensity	Tube Voltage (kVp)	Tube Current (mA)
8x8	Man/Woman/Child	Hard/Normal /Soft	94	9.0

16.2 X-ray Dose Data

16.2.1 DAP (Dose Area Product)

The X-ray dose data is extracted from the X-ray Dose Test Report for **Green X 12 (Model: PHT-75CHS)**.

X-ray Dose Test Report for the **Green X 12 (Model: PHT-75CHS)** maintains dosimetry evaluation that the **VATECH** dental diagnostic system meets all requirements specified in the IEC Collateral Standard. To limit unnecessary exposure to the patient, operator, or other staff, **Green X 12 (Model: PHT-75CHS)** is designed to comply with IEC 60601-1-3 Part 1 General Requirements for Safety.

Test Hardware	
Brand Name (Model)	Green X 12 (Model: PHT-75CHS)
Sensor Type	PANO & CBCT: Xmaru1401CF-Plus CEPH: Xmaru2602CF
X-ray Generator	DG-07E22T2
Tube	D-052SB

DAP (Dose Area Product) is a quantity used in assessing the radiation risk from diagnostic X-ray examination procedures. It is defined as the absorbed dose multiplied by the area irradiated, expressed in gray square centimeters ($\text{mGy}\cdot\text{cm}^2$). Despite the limitation, DAP is the best way to predict effective dose value and is currently the most convenient method for patient dose monitoring.

Accuracy of Radiation

Information of the overall uncertainty of the indicated values of the AIR KERMA and DOSE AREA PRODUCT shall be provided in the ACCOMPANYING DOCUMENT and shall not exceed 50 %

DAP (Dose Area Product) Calculation

$$\text{DAP}[\text{mGy} \cdot \text{cm}^2] = \text{Dose}[\text{mGy}] \times \text{Exposed Area}[\text{cm}^2]$$

NOTICE

When you need more information on DAP measurement procedures or test results for the equipment, please contact **VATECH** service center or your local **VATECH** representative and get assistance from **VATECH**-authorized technicians

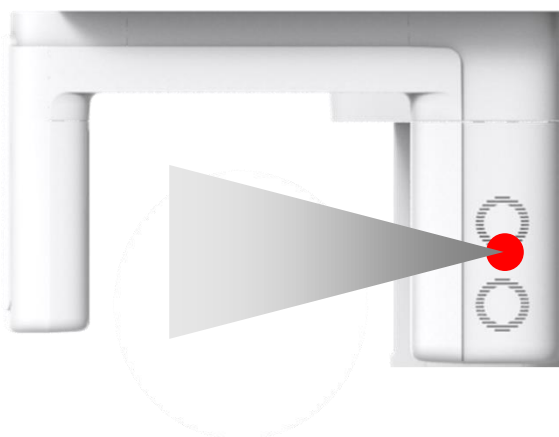
Measurement Overview**Results**

Mode	Exposure Condition	DAP [mGy·cm ²]
PANO Man Normal Standard (High Resolution)	74 kVp / 10 mA / 13.5 s	113.37
PANO Man Normal Standard (Green)	75 kVp / 9 mA / 7.3 s	58.86
PANO Child Normal Standard (High Resolution)	69 kVp / 8 mA / 11.5 s	55.76
PANO Child Normal Standard (Green)	70 kVp / 12 mA / 5.7 s	44.10
PANO Man Normal Insight PAN	70 kVp / 6 mA / 7.5 s	112.42
PANO Child Normal Insight PAN	67 kVp / 6 mA / 5.0 s	69.32
CEPH Man Normal LAT (High Resolution)	90 kVp / 15 mA / 3.9 s	35.79

Mode	Exposure Condition	DAP [mGy·cm ²]
CEPH Man Normal LAT (Green)	90 kVp / 16 mA / 1.9 s	21.69
CEPH Child Normal LAT (High Resolution)	86 kVp / 15 mA / 3.9 s	32.51
CEPH Child Normal LAT (Green)	86 kVp / 16 mA / 1.9 s	19.84
CBCT Man Normal Double Scan (High Resolution)	94 kVp / 12 mA / 13.5 s	1712.54
CBCT Man Normal Double Scan (Green)	87 kVp / 7 mA / 13.5 s	867.48
CBCT Man Normal Smart Focus (High Resolution)	94 kVp / 12 mA / 13.5 s	856.27
CBCT Man Normal Smart Focus (Green)	87 kVp / 7 mA / 13.5 s	433.74
CBCT Man Normal 12x8.5 (High Resolution)	94 kVp / 12 mA / 13.5 s	856.27
CBCT Man Normal 12x8.5 (Green)	87 kVp / 7 mA / 13.5 s	433.74
CBCT Man Normal 8x8 (High Resolution)	94 kVp / 12 mA / 9.0 s	556.78
CBCT Man Normal 8x8 (Green)	87 kVp / 7 mA / 9.0 s	282.03
CBCT Man Normal 8x5 (High Resolution)	94 kVp / 12 mA / 9.0 s	416.88
CBCT Man Normal 8x5 (Green)	87 kVp / 7 mA / 9.0 s	211.17
CBCT Man Normal Endo (High Resolution)	94 kVp / 12 mA / 11.4 s	370.08
CBCT Man Normal Endo (Green)	87 kVp / 10 mA / 11.4 s	268.09
Scout (High Resolution)	94 kVp / 9 mA / 6.2 s	147.79
Scout (Green)	87 kVp / 7 mA / 6.2 s	99.63

*In double scan mode, the system captures a 12x8.5 image twice and stitches the acquired images into one image.

16.3 Leakage Dose

X-ray Leakage Dose Test is performed to protect patients against excessive radiation that is not purposed, and this document evaluates the leakage dose amount based on the following standard defined by IEC regulation and has been performed by covering each collimator region in use.

16.3.1 Standard

National Deviation	Terminology	Permissive Range
International Standard IEC 60601-1-3	Leakage	limits leakage at 1m from the source to 100 mR in 1hr

16.3.2 Measurement Overview

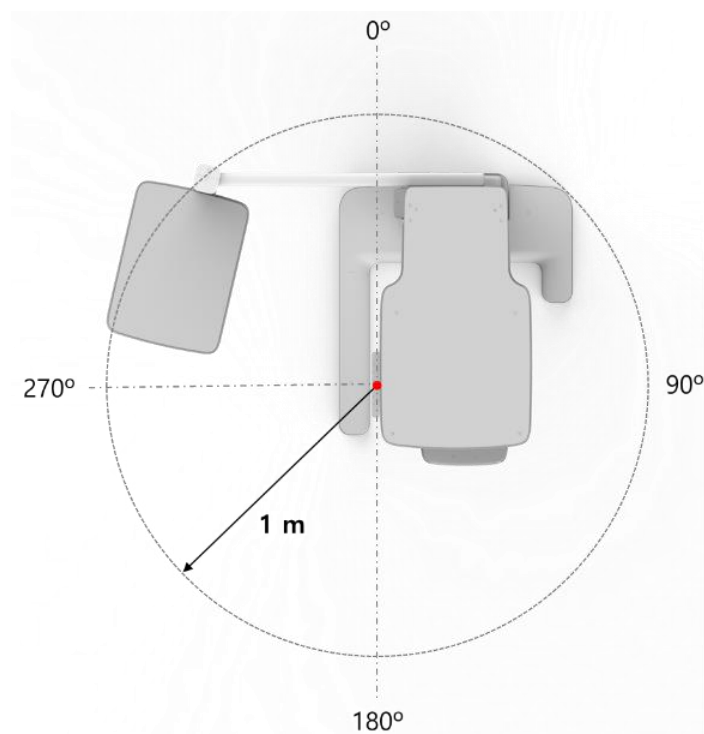

16.3.3 PANO (Adult) Mode Results

Test Condition	
Tested Mode	<ul style="list-style-type: none"> - PANO - Patient: Adult (Man) - Pano option: Normal - Image option: High Resolution - Pano examination: Standard - Arch selection: Normal
Distance from focal point [m]	1
Tube Voltage Peak [kVp]	90
Tube Current [mA]	14
Exposure Time [s]	13.5

Direction [°]	Mode	PANO (Adult)	
		[mR/hr]	[mGy/hr]
0		23	0.202
10		22	0.193
20		21	0.184
30		8	0.070
40		8	0.070
50		8	0.070
60		6	0.053
70		10	0.088
80		7	0.061
90		1	0.009
100		0	0.000
110		2	0.018
120		3	0.026
130		3	0.026
140		3	0.026
150		3	0.026
160		3	0.026
170		7	0.061
180		5	0.044

Direction [°]	Mode	PANO (Adult)	
		[mR/hr]	[mGy/hr]
190		5	0.044
200		20	0.175
210		7	0.061
220		3	0.026
230		1	0.009
240		0	0.000
250		0	0.000
260		0	0.000
270		0	0.000
280		0	0.000
290		0	0.000
300		0	0.000
310		1	0.009
320		5	0.044
330		6	0.053
340		14	0.123
350		22	0.193

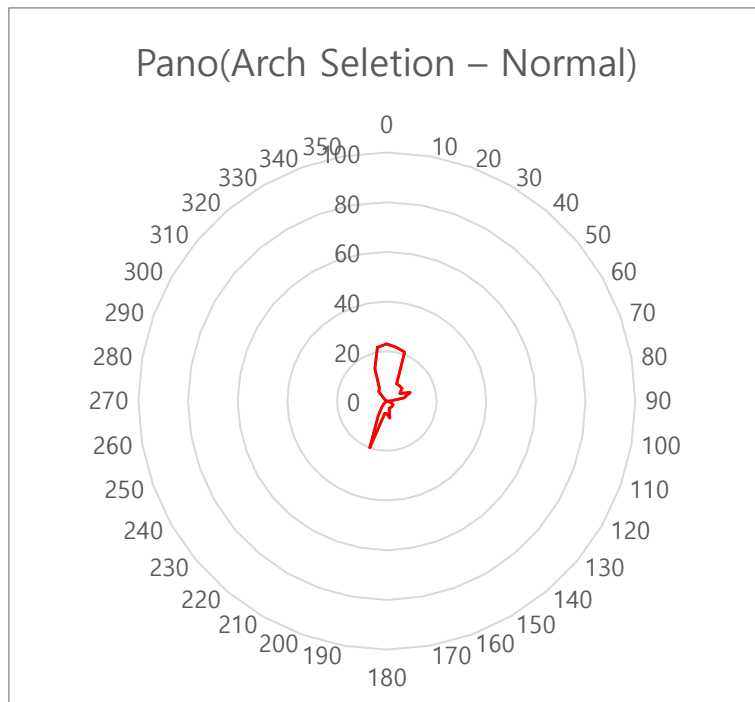

PANO (Normal, Adult/Man) Leakage Dose Test Graph

16.3.4 PANO (Child) Mode Results

Test Condition	
Test Mode	<ul style="list-style-type: none"> - PANO - Patient: Child - Pano option: Normal - Image option: High Resolution - Pano examination: Standard - Arch selection: Child
Distance from focal point [m]	1
Tube Voltage Peak [kVp]	90
Tube Current [mA]	14
Exposure Time [S]	11.5

Direction [°]	Mode	PANO (Child)	
		[mR/hr]	[mGy/hr]
0		26	0.228
10		23	0.202
20		19	0.167
30		8	0.070
40		10	0.088
50		8	0.070
60		6	0.053
70		10	0.088
80		7	0.061
90		2	0.018
100		1	0.009
110		3	0.026
120		4	0.035
130		4	0.035
140		3	0.026
150		3	0.026
160		3	0.026
170		7	0.061
180		5	0.044

Direction [°]	Mode	PANO (Child)	
		[mR/hr]	[mGy/hr]
190		5	0.044
200		19	0.167
210		11	0.096
220		4	0.035
230		2	0.018
240		0	0.000
250		0	0.000
260		0	0.000
270		0	0.000
280		0	0.000
290		1	0.009
300		2	0.018
310		2	0.018
320		3	0.026
330		0	0.000
340		0	0.000
350		13	0.114

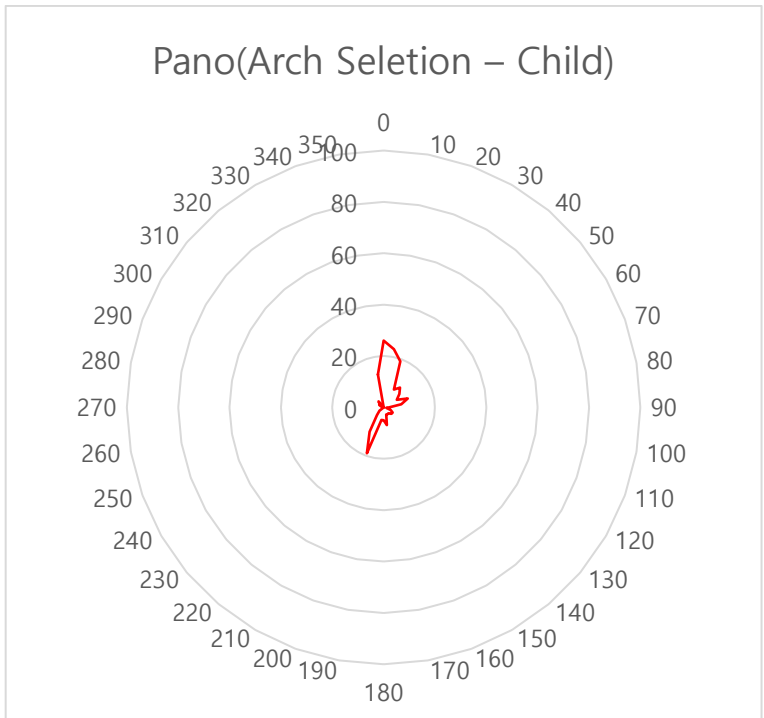

PANO (Normal, Child) Leakage Dose Test Graph

16.3.5 Insight PAN (Adult) Mode Results

Test Condition	
Tested Mode	<ul style="list-style-type: none"> - PANO - Patient: Adult (Man) - Pano option: Insight PAN - Image option: N/A - Pano examination: N/A - Arch selection: Normal
Distance from focal point [m]	1
Tube Voltage Peak [kVp]	90
Tube Current [mA]	14
Exposure Time [S]	10.9

Direction [°]	Mode	Insight PAN (Adult)	
		[mR/hr]	[mGy/hr]
0		25	0.219
10		20	0.175
20		20	0.175
30		7	0.061
40		11	0.096
50		8	0.070
60		5	0.044
70		7	0.061
80		0	0.000
90		0	0.000
100		0	0.000
110		0	0.000
120		0	0.000
130		0	0.000
140		1	0.009
150		1	0.009
160		2	0.018
170		5	0.044
180		4	0.035

Direction [°]	Mode	Insight PAN (Adult)	
		[mR/hr]	[mGy/hr]
190		5	0.044
200		21	0.184
210		12	0.105
220		4	0.035
230		2	0.018
240		0	0.000
250		0	0.000
260		0	0.000
270		0	0.000
280		0	0.000
290		0	0.000
300		0	0.000
310		5	0.044
320		6	0.053
330		9	0.079
340		11	0.096
350		21	0.184

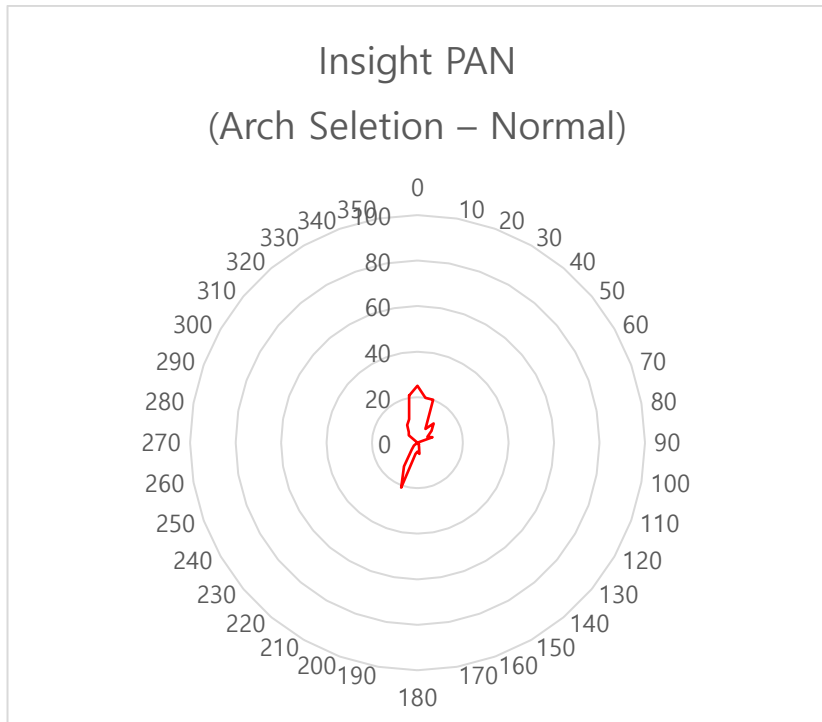

PANO (Insight PAN, Adult/Man) Leakage Dose Test Graph

16.3.6 Insight PAN (Child) Mode Results

Test Condition	
Mode	<ul style="list-style-type: none"> - PANO - Patient: Child - Pano option: Insight PAN - Image option: N/A - Pano examination: N/A - Arch selection: Child
Distance from focal point [m]	1
Tube Voltage Peak [kVp]	90
Tube Current [mA]	14
Exposure Time [S]	8.2

Direction [°]	Mode	Insight PAN (Child)	
		[mR/hr]	[mGy/hr]
0		25	0.219
10		20	0.175
20		20	0.175
30		7	0.061
40		11	0.096
50		8	0.070
60		5	0.044
70		7	0.061
80		0	0.000
90		0	0.000
100		0	0.000
110		0	0.000
120		0	0.000
130		0	0.000
140		1	0.009
150		1	0.009
160		2	0.018
170		5	0.044
180		4	0.035

Direction [°]	Mode	Insight PAN (Child)	
		[mR/hr]	[mGy/hr]
190		5	0.044
200		21	0.184
210		12	0.105
220		4	0.035
230		2	0.018
240		0	0.000
250		0	0.000
260		0	0.000
270		0	0.000
280		0	0.000
290		0	0.000
300		0	0.000
310		5	0.044
320		6	0.053
330		9	0.079
340		11	0.096
350		21	0.184

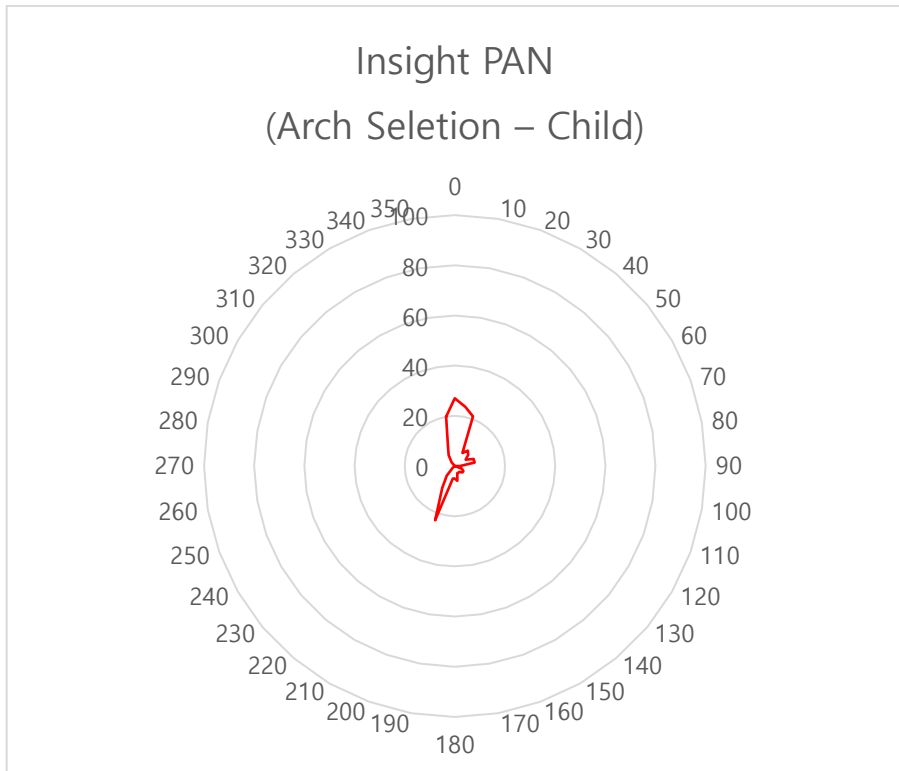

PANO (Insight PAN, Child) Leakage Dose Test Graph

16.3.7 CEPH (Lateral) Mode Results

Test Condition	
Mode	<ul style="list-style-type: none"> - CEPH - Patient: Adult (Man) - Image option: Green - CEPH Examination: Lateral
Distance from the Focal Point [m]	1
Tube Voltage Peak [kVp]	99
Tube Current [mA]	16
Exposure Time [s]	1.9

Direction [°]	Mode	CEPH (Lateral)	
		[mR/hr]	[mGy/hr]
0		38	0.336
10		32	0.284
20		36	0.313
30		11	0.098
40		9	0.081
50		3	0.029
60		1	0.006
70		3	0.023
80		18	0.156
90		20	0.179
100		7	0.064
110		9	0.075
120		5	0.046
130		4	0.035
140		4	0.035
150		4	0.035
160		5	0.041
170		10	0.087
180		8	0.069

Direction [°]	Mode	CEPH (Lateral)	
		[mR/hr]	[mGy/hr]
190		9	0.075
200		28	0.249
210		8	0.069
220		4	0.035
230		3	0.023
240		1	0.012
250		1	0.012
260		0	0.000
270		0	0.000
280		1	0.006
290		1	0.006
300		1	0.006
310		2	0.017
320		7	0.058
330		9	0.081
340		17	0.145
350		30	0.266

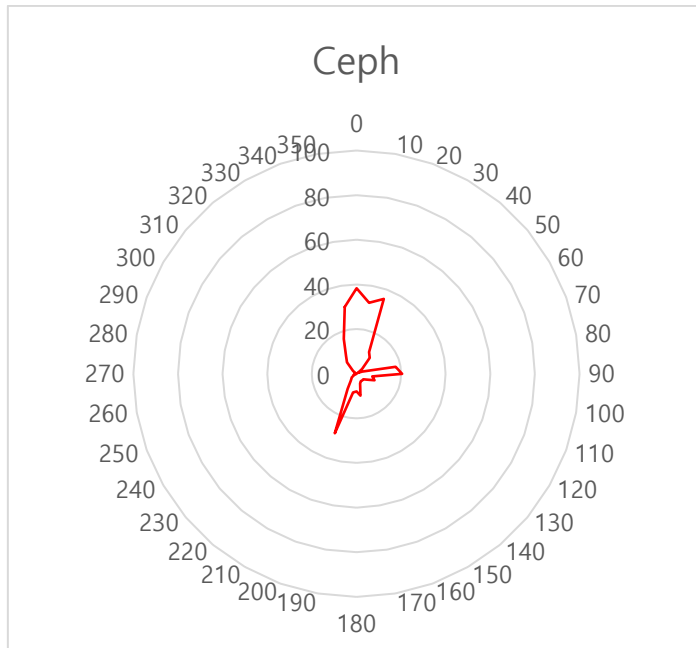

CEPH (Lateral, Green) Leakage Dose Test Graph

16.3.8 CBCT Mode Results

Test Condition	
Test Mode	Test Mode 1 <ul style="list-style-type: none"> - CBCT - Patient: Adult (Man) - FOV: 12x8.5 - Vertical option: Occlusion - Horizontal option: Center - Image option: High resolution - Voxel Size: Standard (0.20)
	Test Mode 2 <ul style="list-style-type: none"> - CBCT - Patient: Adult (Man) - FOV: Endo (Tooth no.:11) - Vertical option: N/A - Horizontal option: N/A - Image option: High resolution - Voxel Size: Application (0.05)
Distance from focal point [m]	1
Tube Voltage Peak [kVp]	99
Tube Current [mA]	12
Exposure Time [s]	16.9 (12x8.5) 11.4 (Endo)

Direction [°]	Mode	12x8.5		4x4 (Endo)	
		[mR/hr]	[mGy/hr]	[mR/hr]	[mGy/hr]
0		49	0.430	57	0.500
10		46	0.404	48	0.421
20		40	0.351	43	0.377
30		17	0.149	15	0.132
40		17	0.149	15	0.132
50		13	0.114	15	0.132
60		12	0.105	11	0.096
70		0	0.000	17	0.149
80		4	0.035	14	0.123

Direction [°]	Mode	12x8.5		4x4 (Endo)	
		[mR/hr]	[mGy/hr]	[mR/hr]	[mGy/hr]
90		2	0.018	5	0.044
100		0	0.000	2	0.018
110		0	0.000	5	0.044
120		7	0.061	8	0.070
130		8	0.070	9	0.079
140		7	0.061	8	0.070
150		7	0.061	8	0.070
160		7	0.061	6	0.053
170		12	0.105	11	0.096
180		14	0.123	12	0.105
190		14	0.123	13	0.114
200		34	0.298	37	0.325
210		14	0.123	12	0.105
220		7	0.061	6	0.053
230		3	0.026	3	0.026
240		1	0.009	0	0.000
250		0	0.000	0	0.000
260		0	0.000	0	0.000
270		0	0.000	0	0.000
280		0	0.000	0	0.000
290		1	0.009	2	0.018
300		2	0.018	2	0.018
310		4	0.035	5	0.044
320		9	0.079	9	0.079
330		11	0.096	11	0.096
340		30	0.263	36	0.316
350		52	0.456	61	0.535

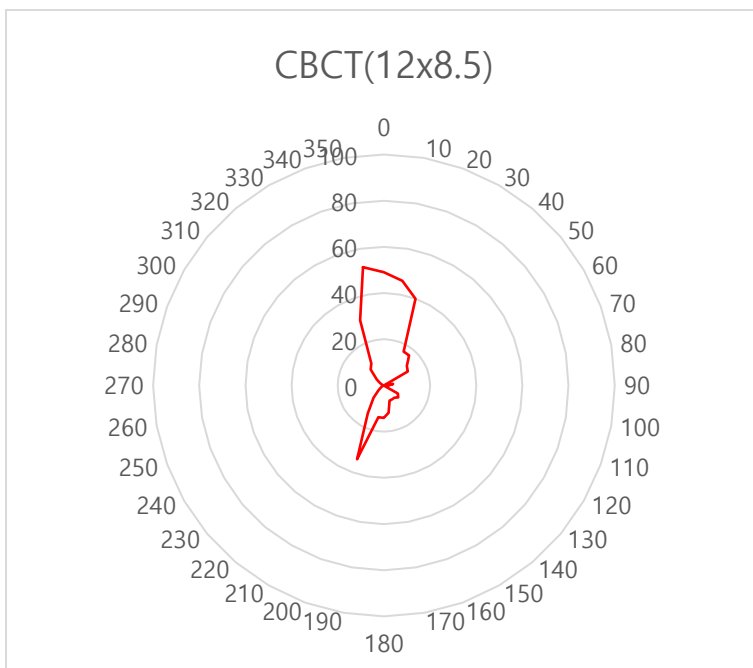

CBCT (12x8x5, High Resolution) Leakage Dose Test Graph

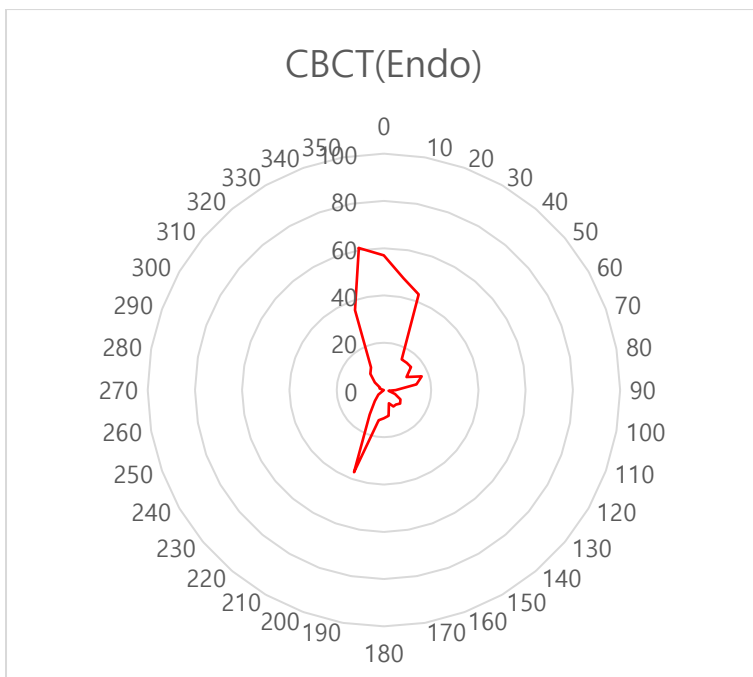

CBCT (Endo, High Resolution) Leakage Dose Test Graph

16.4 Scattered Dose

X-ray Scattered Dose data concerning different angles and distances is examined for recommendations about appropriate radiation level insignificant zones of occupancy, and the effectiveness of protective shielding facility around the patient's position.

This information states the identity and intended position of the tested phantom and scattered dosimetric evaluation under the defined scope and test circumstances to ensure the magnitude of risks to the operator and staff during both accident situations and routine work.

16.4.1 Measurement Overview

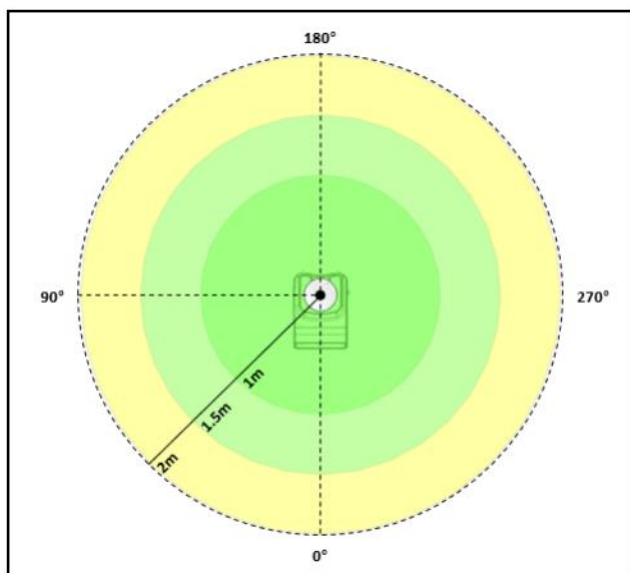

16.4.2 PANO (Adult) Mode Results

Test Condition	
Test Mode	<ul style="list-style-type: none"> - PANO - Patient: Adult (Man) - Pano option: Normal - Image option: High Resolution - Pano examination: Standard - Arch selection: Normal
Distance from focal point [m]	1
Tube Voltage Peak [kVp]	90
Tube Current [mA]	14
Exposure Time [s]	13.5

Condition Direction [°]		PANO (Adult) [mR]		
		1 m (3.3 ft)	1.5 m (4.9 ft)	2 m (6.6 ft)
0	Occiput	0.253	0.128	0.071
45		0.138	0.069	0.038
90	Left ear	0.091	0.047	0.026
135		0.096	0.043	0.024
180	Nose	0.066	0.028	0.016
225		0.096	0.042	0.023
270	Right ear	0.007	0.005	0.004
315		0.149	0.069	0.040

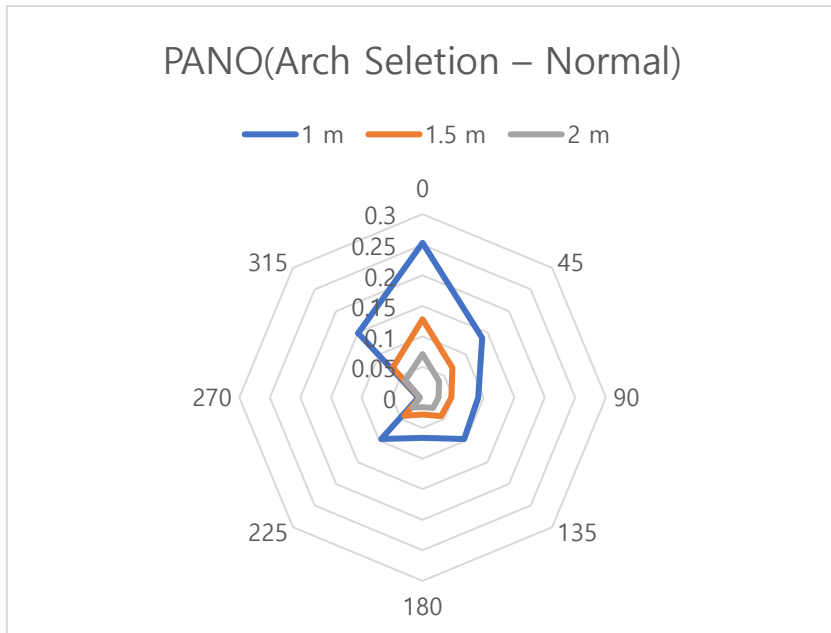

PANO (Normal, Adult/Man) Scattered Dose Test Graph

16.4.3 PANO (Child) Mode Results

Test Condition	
Test Mode	<ul style="list-style-type: none"> - PANO - Patient: Child - Pano option: Normal - Image option: High Resolution - Pano examination: Standard - Arch selection: Child
Distance from focal point [m]	1
Tube Voltage Peak [kVp]	90
Tube Current [mA]	14
Exposure Time [S]	11.5

Condition Direction [°]		PANO (Child) [mR]		
		1 m (3.3 ft)	1.5 m (4.9 ft)	2 m (6.6 ft)
0	Occiput	0.144	0.063	0.034
45		0.122	0.053	0.029
90	Left ear	0.065	0.028	0.015
135		0.0807	0.035	0.019
180	Nose	0.056	0.024	0.013
225		0.076	0.033	0.018
270	Right ear	0.007	0.005	0.003
315		0.102	0.044	0.024

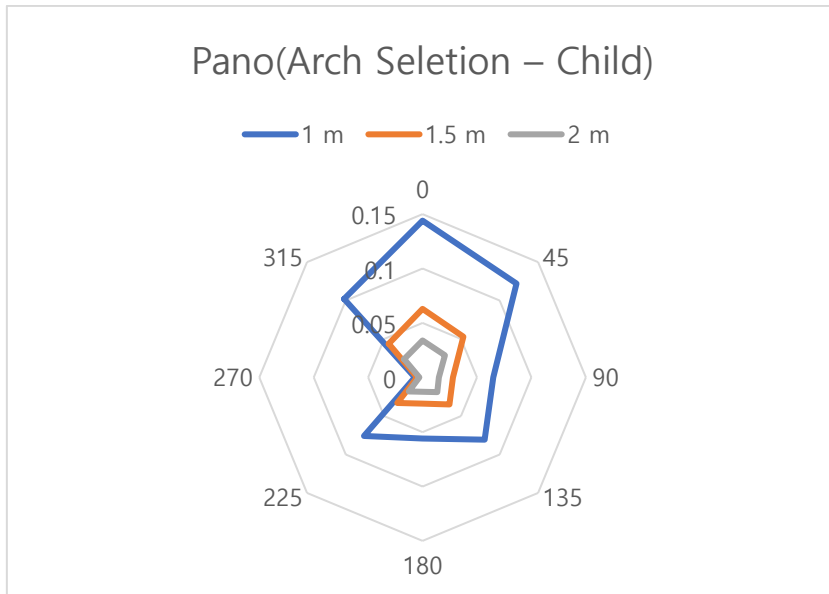

PANO (Normal, Child) Scattered Dose Test Graph

16.4.4 Insight PAN (Adult) Mode Results

Test Condition	
Test Mode	<ul style="list-style-type: none"> - PANO - Patient: Adult (Man) - Pano option: Insight PAN - Image option: N/A - Pano examination: N/A - Arch selection: Normal
Distance from focal point [m]	1
Tube Voltage Peak [kVp]	90
Tube Current [mA]	14
Exposure Time [S]	10.9

Condition		Insight PAN (Adult) [mR]		
		1 m (3.3 ft)	1.5 m (4.9 ft)	2 m (6.6 ft)
0	Occiput	0.525	0.245	0.140
45		0.434	0.201	0.114
90	Left ear	0.456	0.207	0.119
135		0.297	0.142	0.078
180	Nose	0.197	0.100	0.052
225		0.339	0.151	0.087
270	Right ear	0.007	0.005	0.002
315		0.48	0.218	0.124

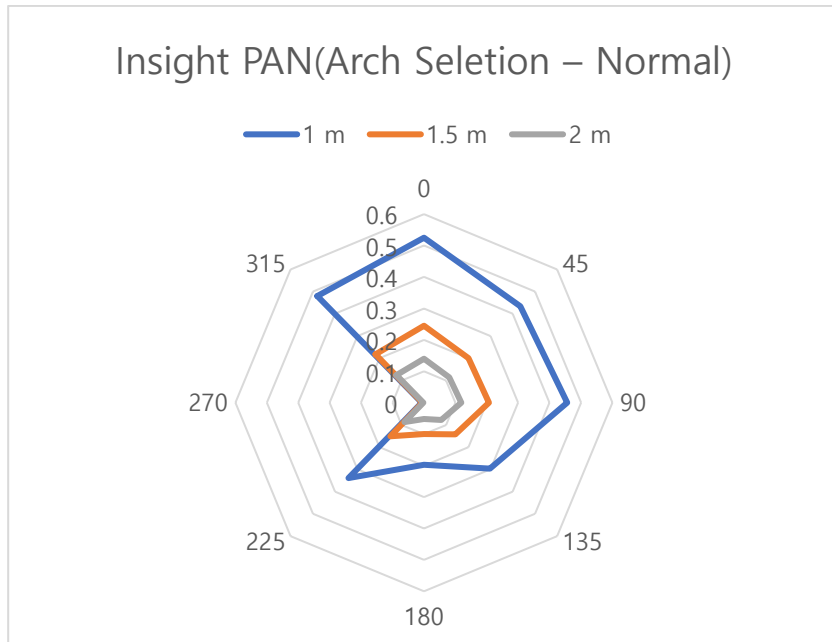

PANO (Insight PAN, Adult/Man) Scattered Dose Test Graph

16.4.5 Insight PAN (Child) Mode Results

Test Condition	
Test Mode	<ul style="list-style-type: none"> - PANO - Patient: Child - Pano option: Insight PAN - Image option: N/A - Pano examination: N/A - Arch selection: Child
Distance from focal point [m]	1
Tube Voltage Peak [kVp]	90
Tube Current [mA]	14
Exposure Time [S]	8.2

Condition		Insight PAN (Child) [mR]		
		1 m (3.3 ft)	1.5 m (4.9 ft)	2 m (6.6 ft)
Direction [°]				
0	Occiput	0.343	0.155	0.088
45		0.309	0.140	0.079
90	Left ear	0.457	0.207	0.117
135		0.251	0.114	0.064
180	Nose	0.188	0.085	0.048
225		0.264	0.119	0.068
270	Right ear	0.015	0.007	0.004
315		0.44	0.199	0.113

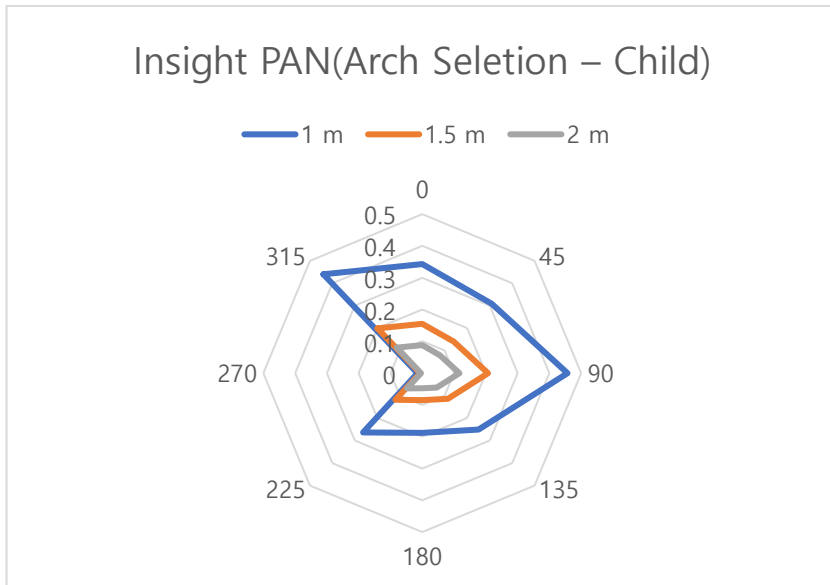

PANO (Insight PAN, Child) Scattered Dose Test Graph

16.4.6 CEPH (Lateral) Mode Results

Test Condition	
Test Mode	<ul style="list-style-type: none"> - CEPH - Patient: Adult(Man) - Image option: Green - CEPH examination: Lateral
Distance from the Focal Point [m]	1
Tube Voltage Peak [kVp]	99
Tube Current [mA]	16
Exposure Time [s]	1.9

Condition		CEPH (Lateral) [mR]		
		1 m (3.3 ft)	1.5 m (4.9 ft)	2 m (6.6 ft)
Direction [°]				
0	Occiput	0.012	0.005	0.003
45		0.012	0.006	0.004
90	Left ear	-	-	0.02
135		0.04	0.019	0.011
180	Nose	0.018	0.009	0.006
225		0.004	0.002	0.001
270	Right ear	0.059	0.028	0.015
315		0.026	0.011	0.005

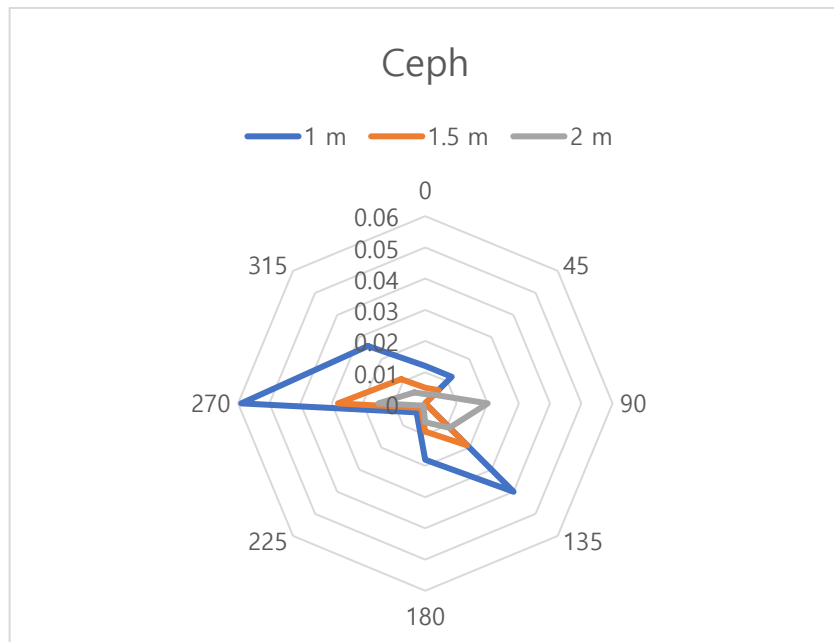

CEPH (Lateral, Green) Scattered Dose Test Graph

16.4.7 CBCT (FOV 12x8.5) Mode Results

Test Condition	
Test Mode	<ul style="list-style-type: none"> - CBCT - Patient: Adult (Man) - FOV: 12x8.5 - Vertical option: Occlusion - Horizontal option: Center - Image option: High resolution - Voxel size: Standard (0.20)
Distance from focal point [m]	1~2
Tube Voltage Peak [kVp]	99
Tube Current [mA]	12
Exposure time [sec]	16.9

Condition		CBCT (FOV 12x8.5) [mR]		
		1 m (3.3 ft)	1.5 m (4.9 ft)	2 m (6.6 ft)
Direction [°]				
0	Occiput	0.822	0.375	0.211
45		0.735	0.337	0.189
90	Left ear	0.621	0.286	0.160
135		0.588	0.271	0.152
180	Nose	0.335	0.159	0.089
225		0.632	0.291	0.153
270	Right ear	0.054	0.029	0.016
315		0.846	0.386	0.215

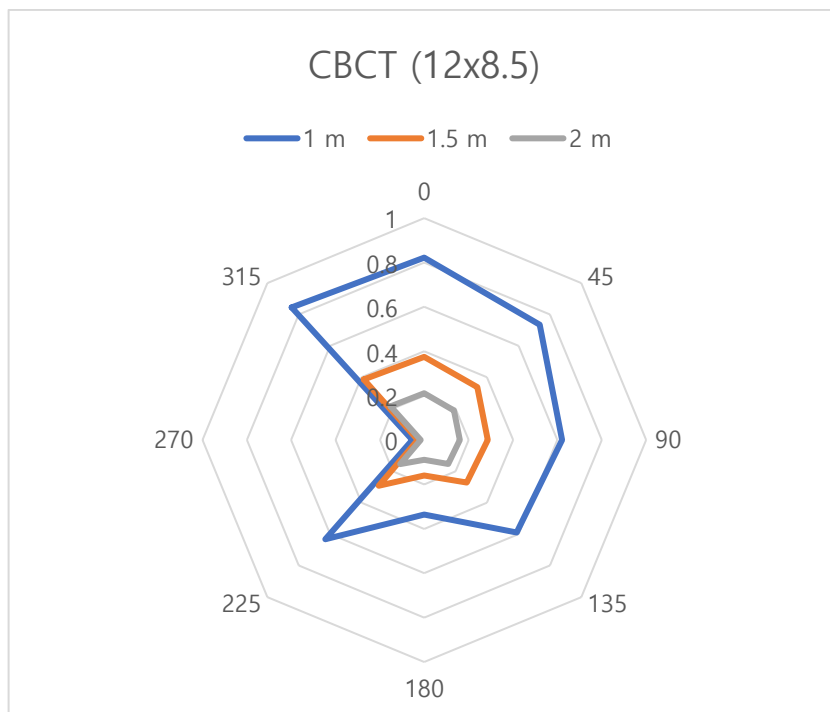

CBCT (12x8.5, High Resolution) Scattered Dose Test Graph

16.4.8 CBCT (Endo) Mode Results

Test Condition	
Test Mode	<ul style="list-style-type: none"> - CBCT - Patient: Adult (Man) - FOV: Endo (Tooth no.:11) - Vertical option: N/A - Horizontal option: N/A - Image option: High resolution - Voxel size: Application (0.05)
Distance from focal point [m]	1~2
Tube Voltage Peak [kVp]	99
Tube Current [mA]	12
Exposure time [sec]	11.4

Condition Direction [°]		CBCT (Endo) [mR]		
		1 m (3.3 ft)	1.5 m (4.9 ft)	2 m (6.6 ft)
0	Occiput	0.215	0.091	0.051
45		0.229	0.098	0.053
90	Left ear	0.249	0.103	0.065
135		0.274	0.117	0.061
180	Nose	0.294	0.126	0.069
225		0.273	0.128	0.064
270	Right ear	0.003	0.002	0.001
315		0.208	0.088	0.049

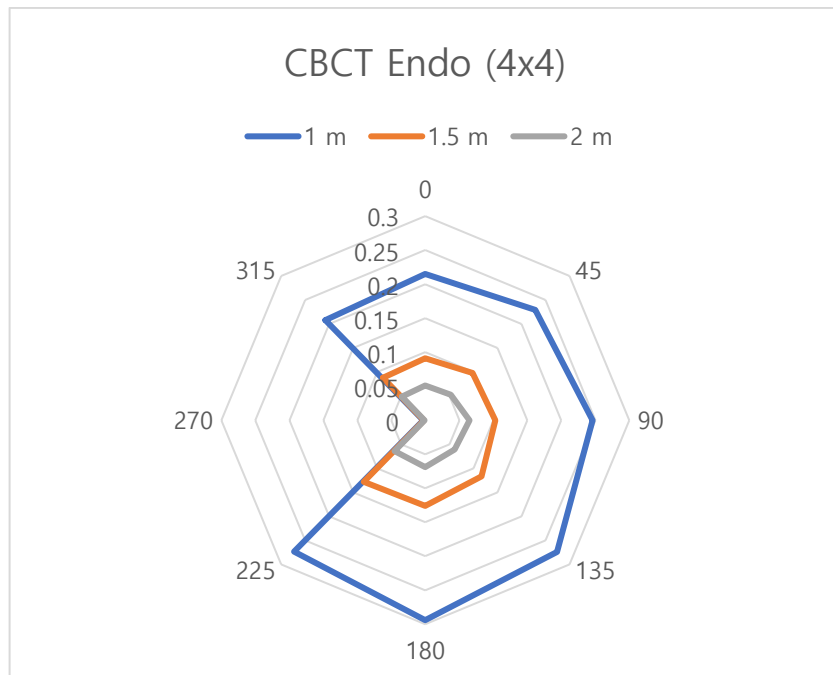

CBCT (Endo, High Resolution) Scattered Dose Test Graph

16.5 Electromagnetic Compatibility (EMC) Information

Phenomenon	Basic EMC standard or test method	Operating mode	Port tested	Test Voltage	Test level/ requirement
Mains terminal disturbance voltage	CISPR 11:2015 +A1:2016+A2:2019 EN 55011:2016 /A2:2021	IDLE mode CT mode PANO mode CEPH mode	AC Mains of the power supply unit	AC 100 V, 50 Hz AC 100 V, 60 Hz AC 220 V, 60 Hz AC 240 V, 60 Hz	Group1, Class A
Radiated disturbance	CISPR 11:2015 +A1:2016+A2:2019 EN 55011:2016 /A2:2021	IDLE mode CT mode PANO mode CEPH mode	Enclosure	AC 100 V, 50 Hz AC 100 V, 60 Hz AC 220 V, 60 Hz AC 230 V, 50 Hz	Group1, Class A
Harmonic Current Emission	IEC 61000-3-2:2018 +A1:2020 EN IEC 61000-3-2:2019	IDLE mode CT mode PANO mode CEPH mode	AC Mains of the power supply unit	AC 220 V, 60 Hz AC 230 V, 50 Hz	Class A
Voltage change, Voltage fluctuations and Flicker Emission	IEC 61000-3-3:2013 +A1:2017 EN 61000-3-3:2013 +A1:2019	IDLE mode CT mode PANO mode CEPH mode	AC Mains of the power supply unit	AC 220 V, 60 Hz AC 230 V, 50 Hz	Pst: 1 Plt: 0.65 dmax: 4% dc: 3.3%
Electrostatic Discharge Immunity	IEC 61000-4-2:2008 EN 61000-4-2:2009	IDLE mode CT mode PANO mode CEPH mode	Enclosure	AC 100 V, 50 Hz AC 100 V, 60 Hz AC 220 V, 60 Hz AC 230 V, 50 Hz	± 8 kV/Contact ± 2, ± 4, ± 8, ± 15 kV/Air
Radiated RF Electromagnetic Field Immunity	IEC 61000-4-3:2020 EN IEC 61000-4-3:2020	IDLE mode CT mode PANO mode CEPH mode	Enclosure	AC 100 V, 50 Hz AC 100 V, 60 Hz AC 220 V, 60 Hz AC 230 V, 50 Hz	3 V/m 80 MHz-2.7 GHz 80% AM at 1 kHz
Immunity to Proximity Fields from RF wireless Communications Equipment	IEC 61000-4-3:2020 EN IEC 61000-4-3:2020	IDLE mode CT mode PANO mode CEPH mode	Enclosure	AC 100 V, 50 Hz AC 100 V, 60 Hz AC 220 V, 60 Hz AC 230 V, 50 Hz	Table 9 in IEC 60601-1-2:2014
Immunity to proximity magnetic fields in the frequency range 9 kHz to 13.56 MHz	IEC 61000-4-39:2017 EN 61000-4-39:2017	IDLE mode CT mode PANO mode CEPH mode	Enclosure	AC 100 V, 50 Hz AC 100 V, 60 Hz AC 220 V, 60 Hz AC 230 V, 50 Hz	Table 11 in IEC 60601-1-2:2020
Electrical Fast Transient/Burst Immunity	IEC 61000-4-4:2012 EN 61000-4-4:2012	IDLE mode CT mode PANO mode CEPH mode	AC Mains Exposure switch cable	AC 100 V, 50 Hz AC 100 V, 60 Hz AC 220 V, 60 Hz AC 230 V, 50 Hz	AC Line: ± 2 kV Signal: ±1 kV 100 kHz repetition frequency

Surge Immunity	IEC 61000-4-5:2014 +A1:2017 EN 61000-4-5:2014 +A1:2017	IDLE mode CT mode PANO mode CEPH mode	AC Mains of the power supply unit	AC 100 V, 50 Hz AC 100 V, 60 Hz AC 220 V, 60 Hz AC 230 V, 50 Hz	Line to Line ± 0.5 kV, ± 1 kV Line to Ground ± 0.5 kV, ± 1 kV, ± 2 kV
Immunity to Conducted Disturbances Induced by RF fields	IEC 61000-4-6:2013 EN 61000-4-6:2014	IDLE mode CT mode PANO mode CEPH mode	AC Mains	AC 100 V, 50 Hz AC 100 V, 60 Hz AC 220 V, 60 Hz AC 230 V, 50 Hz	AC Line & Signal: 3 V, 0.15-80 MHz
			Exposure switch cable		6 V in ISM bands Between 0.15 MHz and 80 MHz 80% AM at 1 kHz
Power Frequency Magnetic Field Immunity	IEC 61000-4-8:2009 EN 61000-4-8:2010	IDLE mode CT mode PANO mode CEPH mode	Enclosure	AC 100 V, 50 Hz AC 100 V, 60 Hz AC 220 V, 60 Hz AC 230 V, 50 Hz	30 A/m 50 Hz & 60 Hz
Voltage dips	IEC 61000-4-11:2020 EN IEC 61000-4-11:2020	IDLE mode CT mode PANO mode CEPH mode	AC Mains of the power supply unit	AC 100 V, 50 Hz AC 100 V, 60 Hz AC 220 V, 60 Hz AC 240 V, 50 Hz AC 240 V, 60 Hz	0 % U_T : 0.5 cycle At 0°, 45°, 90°, 135°, 180°, 225°, 270° and 315° 0 % U_T : 1 cycle and 70 % U_T : 25/30 cycles Single phase: at 0°
Voltage interruptions	IEC 61000-4-11:2020 EN IEC 61000-4-11:2020	IDLE mode CT mode PANO mode CEPH mode	AC Mains of the power supply unit	AC 100 V, 50 Hz AC 100 V, 60 Hz AC 220 V, 60 Hz AC 240 V, 50 Hz AC 240 V, 60 Hz	0 % U_T : 250/300 cycle

16.6 Acquiring Images for Pediatric Dental Patients

16.6.1 Age Group: Classification Table

Ages are classified loosely into the following correspondence between the FDA definition and the one used in this manual.

Age Group	FDA's standard	VATECH's Standard
Infant	1 month to 2 years	N/A
Child	2 ~ 12 years of age	Child
Adolescent	12 ~16 years of age	Adult
Other	16 ~ 21 years of age	
Adult	> 21 years of age	

16.6.2 Positioning the Pediatric Dental Patients

1. Use a laser light beam guide to locate the midsagittal plane. Direct patient focuses on mirroring reflection. Affix decal to mirror to aid the patient in maintaining the correct position throughout the exposure.
2. Move the Chinrest into a position that is slightly higher than the patient's chin height before requesting that the weak place chin onto the rest. Direct the patient to assume a position that resembles the erect stance of a soldier.
3. Direct the patient to stick out the chest while dropping the chin down. While holding the unit handles for stability, direct the patient to take a half step toward the vertical column of the X-ray device into a position that feels as if he/she is slightly leaning backward.
4. Direct the patient to close lips around the Bite Block during the exposure.
5. Direct the patient to swallow and note the flat position of the tongue. Request that the patient sucks in the cheeks, pushing the tongue into the correct flat position against the palate and maintain this position throughout the exposure.

<How to produce error-free radiographic images for the pediatric patient>

- By Evelyn M. Thomson, BSDH, MS

Panoramic radiographs are often recommended for assessing the growth and development of the pediatric patient and for evaluation of developing third molars during adolescence.¹⁻³ While the panoramic technique seems relatively straightforward, producing a diagnostic-quality image of the pediatric patient requires a mastery of technical skills.⁴ Modern panoramic x-ray equipment is designed for ease of use, yet studies continue to demonstrate a high incidence of errors.⁵⁻⁷ Positioning errors may occur at an even higher rate in pediatric panoramic radiographs.⁷ The goal of the dental hygienist is to maximize the use of panoramic imagery in the assessment of the pediatric patient while minimizing the occurrence of retakes that result from a radiographic error.

Producing A Quality Panoramic Image

A quality panoramic radiograph should image all of the teeth, erupted and unerupted, in both the maxillary and mandibular arches from condyle to condyle in the horizontal dimension, and from the superior third of the orbit in the superior region to the inferior border of the mandible in the inferior region.^{8,9} The arches should appear straight or slightly U-shaped with the occlusal plane parallel to the horizontal edges of the film (**Figure 1**). The anterior teeth must not be magnified or diminished in size, and overlapping of adjacent posterior teeth should be kept to a minimum.



Figure 1: Example of a diagnostically acceptable panoramic radiograph of an adolescent patient undergoing orthodontic intervention. (Courtesy of Jamie Mace and Will Wright of Schick Technologies Inc.)

The most critical component in producing a diagnostically acceptable panoramic image is patient positioning. All panoramic x-ray machines have guidelines to assist with positioning the dental arches within the three dimensions of the focal trough, an area where the anatomical structures will be imaged in relative clarity. Most

panoramic x-ray machines have a bite block to indicate the correct anterior-posterior position, or how far forward or back the patient should be positioned, side positioner guides for determining the correct lateral alignment, and chin rest to correctly locate the superior-inferior dimension or how far up or down the chin should be positioned.^{4,10} Panoramic x-ray machines are available with a mirror and laser light beam guide that shines on the patient's face to illustrate various anatomical planes (**Figure 2**). Incorrectly positioning the patient in any of these three dimensions will produce unique and distinct radiographic image errors (**Table 1**).



Figure 2: Laser light beam guides that assist with determining correct patient positioning.

Table 1. Common Panoramic Positioning Errors

Error	Cause	Corrective action	Tips for pediatric patients
Anterior teeth narrow Severe posterior overlap Vertebrae superimposed over condyles	Arches positioned too far anterior	Position anterior teeth in appropriate position on bite guide.	Use a cotton roll to fill in missing primary teeth or partially erupted permanent teeth. Adapt adult recommendation for direction of laser light beam guide for use with primary teeth.
Anterior teeth wide, blurred out of image Condyles not imaged	Arches positioned too far posterior	Locate appropriate position with anterior laser light guide.	Observe laser light beam guide on both the right and left sides.
Teeth on the right side appear narrowed, severely overlapped Teeth on the left side appear broad, poorly defined Condyles asymmetrical in width and height	Arches tipped or tilted to the right	Position the midsagittal plane perpendicular to the floor.	Use laser light beam guide to locate midsagittal plane. Direct patient focus to mirror reflection.
Teeth on the left side appear narrowed, severely overlapped Teeth on the right side appear broad and poorly defined Condyles asymmetrical in width and height	Arches tipped or tilted to the left		Affix decal to mirror to aid patient in maintaining the correct position throughout exposure.
Flat, downward-turned, "frown" appearance to the occlusal plane Palate appears as a widened, thick, dense radiopacity Condyles flare out off the edges of the image Anterior teeth appear wide, elongated	Arches positioned too far superior	Position the Frankfort or the canthometal plane parallel to the floor, or the ala-tragus line 5" down toward the floor.	Move chin rest into a position that is slightly higher than the patient's chin height before requesting that the patient place chin onto the rest. Direct the patient to assume a position that resembles the erect stance of a soldier.
Exaggerated upward curve of the occlusal plane creating a "smile" appearance Hyoid bone superimposed over the mandible Condyles tilt inward Anterior teeth appear narrowed; elongated in the maxilla and foreshortened in the mandible	Arches positioned too far inferior		
Pyramid-shaped radiopacity superimposed over the anterior teeth	Patient in slumped position	Position the back and neck straight.	Direct the patient to stick out the chest while dropping the chin down. While holding the unit handles for stability, direct the patient to take a half step in toward the vertical column of the x-ray machine into a position that feels as if he/she is slightly leaning backward.
Radiolucent shadow of the commissure superimposed over the teeth, mimicking caries	Lips not closed around bite block	Position the lips around the bite block.	Direct the patient to keep the lips closed around the bite block during the exposure.
Radiolucency superimposed over the maxillary teeth apices	Tongue not placed against palate	Position the tongue flat against the roof of the mouth.	Direct the patient to swallow and note the flat position of the tongue. Request that the patient suck in the cheeks, pushing the tongue into the correct flat position against the palate and maintain this position throughout the exposure.

FEBRUARY 2009

Dimensions OF DENTAL HYGIENE

Anterior-Posterior Positioning Error

When the arches are positioned incorrectly in the anterior-posterior direction, distortion or ghosting of the anterior anatomy occurs. Unerupted teeth in the anterior region may not be imaged on the radiograph if positioned outside of the focal trough. It is important to note that an error of only 3 mm to 4 mm in either direction will result in a significantly compromised image.¹¹ When the arches are positioned too far anterior, the anterior teeth will appear narrow and diminished in size. The vertebrae of the spinal column may be superimposed over the condyles at the edges of the film and, depending on the size of the child, may be superimposed over the rami of the mandible blocking a clear view of the posterior teeth (**Figure 3**). When the arches are positioned too far posteriorly, the anterior teeth will appear broad or widened. If the position is excessively posterior, anterior teeth may be blurred entirely from the image, and the condyles may be cut off from the edges of the film.



Figure 3: Incorrect position too far anteriorly. Note the narrow anterior teeth and superimposition of the spinal column over the condyles. The radiolucency superior to the maxillary apices indicates that the tongue was not placed against the palate. An open lip line can also be detected.

To avoid these imaging errors, the anterior teeth must occlude edge-to-edge onto the designated area of the bite block. Achieving this position is easily compromised during exfoliation of primary teeth, making precise occlusion difficult when one tooth or multiple teeth are missing or partially erupted. A cotton roll may be attached to the bite block to fill in the space created by the missing tooth or teeth. Additionally, an adjustment may be necessary when using a laser light beam guide. The manufacturer's instructions for directing the laser light beam at a predetermined tooth or interproximal space usually apply to adult patients. These instructions may need to be modified for the pediatric patient with primary or mixed dentition.

Lateral Left-Right Positioning Error

When the arches are positioned incorrectly in the lateral left-right dimension, the posterior teeth on one side will appear broad or widened, while the teeth on the other side will appear narrowed or diminished in width and severely overlapped (**Figure 4**). This image distortion is like that which occurs with an incorrect anterior-posterior position. When the arches are rotated or tilted, the posterior teeth on one side move out of the focal trough to a position further away (back) from the image receptor, while the opposite side simultaneously moves closer (forward) to the image receptor. Depending on the severity of rotation or tilting, the inferior border of the mandible will appear distorted, and the condyles and rami will appear asymmetrical.



Figure 4: Incorrect lateral position tilted to the right. Note the teeth on the left are wide and poorly defined, while the teeth on the right are narrowed and severely overlapped. The inferior border of the mandible is distorted and the condyles appear asymmetrical.

To avoid imaging errors that result from incorrect lateral positioning, the midsagittal plane must be positioned perpendicular to the floor. Most panoramic x-ray machines have a head positioner and laser light beam guide, along with a mirror, to assist in determining the correct lateral head position. The pediatric patient may need additional instructions to maintain the correct position throughout the exposure.

The movement of the tube head during exposure may pique the pediatric patient's curiosity, causing the head to rotate as the eyes follow the movement of the tube head. A vertical line decal affixed to the mirror can serve as a visual aid and a focus point. An eye-catching sticker, such as those purchased from a craft store, can be adhered to the mirror in a position that aligns with the midsagittal plane. The patient can be directed to position the head so that the sticker appears at the tip of the nose and to maintain focus on this reflection throughout the exposure. Pediatric patients may find looking at themselves in the mirror entertaining and a fun way to participate in the process.⁹

Superior-Inferior (Up-Down) Positioning Error

Positioning the dental arches within the superior-inferior (up-down) dimension of the focal trough can be challenging to achieve, especially with children whose smaller size reduces the distance between the shoulders and the inferior border of the chin. When the arches are positioned incorrectly in the superior-inferior direction, the image exhibits multiple distortions, including increased overlap in the premolar regions. When the arches are positioned too far up or down, the teeth will simultaneously move into a position that is too far back or too far forward, respectively, out of the focal trough.¹¹

Positioning the arches too far superiorly produces a characteristic "frown" or flat, downward-turned appearance to the occlusal plane (**Figure 5**). The condyles flare out and off the edges of the image, and the palate appears as a widened, thick, dense radiopacity. This positioning error results in a widened appearance of the palate and obliterates the apical regions of the maxillary teeth, compromising the images of the unerupted developing dentition. As the maxillary arch tips upward, the anterior teeth tilt backward, producing the same widened appearance that results from an incorrect anterior-posterior position. Positioning the arches too far inferior produces a characteristic "smile" appearance or the upward curve of the occlusal plane, with the condyles tilting inward toward the center of the image (**Figure 6**). Depending on the severity of the downward position, the vertebrae may also curve inward and appear superimposed over the condyles, and the hyoid bone may be superimposed over the mandible blocking a clear view of the erupted and unerupted mandibular teeth.

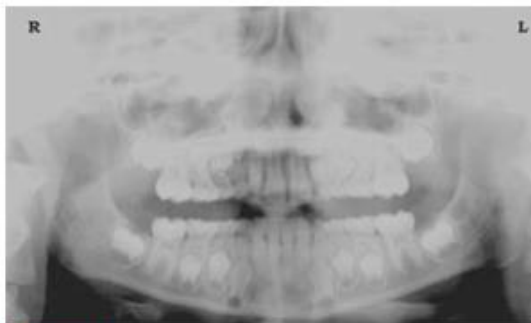

Figure 5: Chin positioned too far up. Note the characteristic "frown" or flat, downward-turned appearance to the occlusal plane. The widened palate obscures the view of the maxillary apices and the developing permanent dentition.

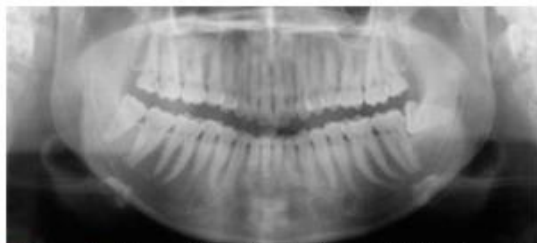

Figure 6: Chin positioned too far down. Note the characteristic “smile” or upward curved appearance to the occlusal plane and the hyoid bone superimposed over the mandible.

Correct positioning of the arches in the superior-inferior dimension requires that the patient stands with an erect posture while tucking the chin in and down slightly, a direction that both adults and pediatric patients often find difficult to follow without specific guidance. The result is often a slumped position with the patient hunching the neck and shoulders over to place the chin on the chin rest. The vertebrae collapse causing attenuation of the x-ray beam that produces a triangular radiopacity superimposed over the mandible and, if severe, over the anterior maxillary regions as well.

Depending on the manufacturer, panoramic x-ray machines direct the operator to position the Frankfort or the canthomeatal plane parallel to the floor or the ala-tragus line 5° down toward the floor. This is achieved by raising or lowering the chin rest so that the appropriate landmark lines up with indicators on the machine (**Figure 2**). The patient should be directed to stand in front of the panoramic x-ray machine allowing the operator to place the chin rest in a position that is slightly higher than the patient's chin. The patient is then requested to move into the overhead assembly of the machine and remain standing tall. If further adjustment is needed, it is usually to a lowered chin position. Once the patient's chin is resting on the chin rest, it is easier to move to a lower position than to a higher one. To assist with placing the chin on the chin rest while maintaining an erect posture, the pediatric patient can be directed to stand like a soldier. Most children are familiar with the straight back, chest forward, tucked chin position demonstrated by military persons, and can readily mimic this stance.

Further Recommendations

Before beginning the exposure, the patient should be directed to close the lips around the bite block and to place the tongue against the palate. Leaving the lips open will create a soft tissue shadow across the teeth that can be mistaken for caries.⁷ Leaving the tongue at rest during the exposure allows the radiation to easily penetrate the

space of the oral cavity between the dorsal surface of the tongue and the palate, producing a radiolucent shadow that diminishes the diagnostic quality of the radiograph (Figure 3).

"Filling in" this space with the soft tissue of the tongue can increase the quality of the image by diminishing this radiolucent shadow. When directed to place the tongue on the roof of the mouth, the pediatric patient is likely to press only the tip of the tongue against the palate. While an adult patient can usually understand what is required when directed to swallow and note the position of the tongue, a child may be directed to suck in the cheeks, which results in pushing the tongue into a position flat against the palate.⁷

Conclusion

In addition to these guidelines for producing error-free radiographic images for pediatric patients, panoramic machines should be evaluated periodically for accuracy. Changes may occur over time to the focal trough that interferes with the diagnostic quality of the machine.⁶ If a decrease in image quality is noted despite following accurate patient positioning steps, the panoramic x-ray machine should be inspected, and the focal trough recalibrated. The dental hygienist who is skilled in understanding general equipment operation and pediatric patient management is more likely to produce radiographic images that result in higher diagnostic yields.

References

1. Public Health Service, Food and Drug Administration, American Dental Association Council on Dental Benefits Program, Council on Dental Practice, Council on Scientific Affairs. *The Selection of Patients for Dental Radiographic Examinations*. Washington, DC: United States Department of Health and Human Services; 1987 (revised 2005):1-23.
2. Pinkham PS, Casamassimo, Fields HW, McTigue DJ, Nowak AJ. *Pediatric Dentistry Infancy Through Adolescence*. 4th ed. St. Louis: Elsevier Saunders; 2005:677.
3. Thomson EM. *Panoramic radiographs and the pediatric patient*. *Dimensions of Dental Hygiene*. 2008;6(2):26-29.
4. Rushton VE, Rout J. *Panoramic Radiology*. London: Quintessence Publishing Co Ltd; 2006:17, 84-85.
5. Kullman L, Joseph B. *Quality of digital panoramic radiography in a newly established dental school*. *Swedish Dent Journal*. 2006; 30: 165-170.
6. Akarslan ZZ, Erten H, Güngör K, et al. *Common errors on panoramic radiographs taken in a dental school*. *J Contemp Dent Pract*. 2003; 4:24-34.
7. Rushton VE, Horner K, Worthington HV. *The quality of panoramic radiographs in a sample of*

general dental practices. Br Dent J. 1999; 26: 630-633.

8. *White SC, Heslop EW, Hollender LG, Mosier KM, Ruprecht A, Shroul MK. Parameters of radiologic care: an official report of the American Academy of Oral and Maxillofacial Radiology. Oral Surg Oral Med Oral Pathol. 2001; 91:498-511.*

9. *McDonald RE, Avery DR, Dean JA. Dentistry for the Child and Adolescent. 8th ed. St. Louis: Elsevier Mosby; 2000:71-72.*

10. *Johnson ON, Thomson EM. Essentials of Dental Radiography for Dental Assistants and Hygienists. 8th ed. Upper Saddle River, NJ: Prentice-Hall 2007:388-397.*

11. *Serman N, Horrell BM, Singer, S. High-quality panoramic radiographs. Tips and tricks. Dentistry Today. 2003;22(1):70-73.*

16.6.3 Setting Exposure Values to the Age Group

For more information about this topic, refer to the Appendices **15.1 Recommended X-Ray Exposure Table**.

16.6.4 The References Pertinent to the Potential Risks for the Pediatric Patients

1) Literature

- I. ESPELID, I. MEJÅRE, K. WEERHEIJM:

EAPD guidelines for the use of radiographs in children, P40-48. European Journal of Pediatric Dentistry 1/2003 Guidelines in dental radiology are designed to avoid unnecessary exposure to X-radiation and to identify individuals who may benefit from a radiographic examination. Every prescription of radiographs should be based on an evaluation of the individual patient's benefit. Due to the relatively high frequency of caries among 5-year-old children, it is recommended to consider dental radiography for each child even without any visible caries or restorations. Furthermore, radiography should be considered at 8-9 years of age and then at 12-14, which is 1-2 years after the eruption of premolars and second molars. Additional bitewing controls should be based on an overall assessment of the caries activity/risk. The high-risk patient should be examined radiographically annually, while a 2-3 year interval should be considered when caries activity/risk is low. A routine survey by radiographs, except for caries, has not been shown to provide enough information to be justified considering the balance between cost (radiation and resources) and benefit.

- MICHAEL L. TAYLOR, B.SC. TOMAS KRON, PH.D., AND RICK D. FRANICH, PH.D.:

ASSESSMENT OF OUT-OF-FIELD DOSES IN RADIOTHERAPY OF BRAIN LESIONS IN CHILDREN, *Int. J. Radiation Oncology Biol. Phys.*, Vol. -, No. -, pp. 1–7, 2010 To characterize the out-of-field doses in pediatric radiotherapy and to identify simple methods by which out-of-field dose might be minimized, to reduce the risk of secondary cancers Out-of-field doses to pediatric patients can be minimized by using simple treatment

- C. THEODORAKOU, K. HORNER, K. HOWARD, A. WALKER:

Pediatric organ and effective doses in dental cone beam computed tomography Dental CBCT has been associated with higher radiation risk to the patients compared to conventional dental X-ray imaging. Several studies have investigated the radiation doses involved in dental CBCT for adults, but none has investigated pediatric doses. This study estimates the organ and effective doses for two pediatric tissue-equivalent phantoms using thermoluminescent dosimeters for three dental CBCT units and six imaging protocols. The doses to the thyroid, salivary glands and brain ranged from 0.068mSv to 1.131mSv, 0.708mSv to 2.009mSv and 0.031mSv to 1.584mSv respectively. The skin and red bone marrow have received much lower doses than the other three organs. The effective doses ranged from 0.022 mSv to 0.081 mSv. The effective doses calculated in this study were much higher than these of panoramic X-ray imaging but lower than conventional CT

- CHIYO YAMAUCHI-KAWAURA & KEISUKE FUJII & TAKAHIKO AOYAMA & SHUJI KOYAMA & MASATO YAMAUCHI:

Radiation dose evaluation in the head and neck MDCT examinations with a 6-year-old child anthropomorphic phantom, *Pediatr Radiol* (2010) 40:1206–1214 DOI 10.1007/s00247-009-1495-z

Background: CT examinations of the head and neck are the most commonly performed CT studies in children, raising concerns about radiation dose and their risks to children.

Objective: The purpose of this study was to clarify radiation dose levels for children 6 years of age undergoing head and neck multi-detector CT (MDCT) examinations.

Materials and methods: Radiation doses were measured with small-sized silicon photodiode dosimeters that were implanted at various tissue and organ positions within a standard 6-year-old anthropomorphic phantom. Organ and effective

doses of brain CT were evaluated for 19 protocols in nine hospitals on various (2–320 detector rows) MDCT scanners.

Results: The maximum value of the mean organ dose in brain CT was 34.3 mGy for brain. Maximum values of mean doses for the radiosensitive lens and thyroid were 32.7 mGy for a lens in brain CT and 17.2 mGy for thyroid in neck CT. The seventy-fifth percentile of effective dose distribution in brain CT was approximately the same as the diagnostic reference level (DRL) in the 2003 UK survey.

2) Website

For additional information on pediatric X-ray imaging, please refer to the websites below.

- <http://www.fda.gov/radiation-emittingproducts/radiationemittingproductsandprocedures/medicalimaging/ucm298899.htm>
- <http://www.imagegently.org/>

16.7 Abbreviations

AC	Alternating Current
AF	Auto Focusing
CAN	Controlled Area Network
CBCT	Cone-Beam Computed Tomography
CEPH	Cephalogram
CMOS	Complementary Metal-Oxide -Semiconductor
CRS	Chronic Rhinosinusitis
CT	Computed Tomography
DAP	Dose Area Product
DC	Direct Current
DICOM	Digital Imaging and Communications in Medicine
EMC	Electromagnetic Compatibility
ESD	Electrostatic Discharge
EUT	Equipment Under Test
FDD	A focal spot to Detector Distance
FOD	A focal spot to Object Distance
FOV	Field of View
FPD	Flat Panel Detector

IEC	International Electrotechnical Commission
ISO	International Standards Organization
LCD	Liquid Crystal Display
LED	Light-Emitting Diode
MPSO	Multiple Portable Socket-Outlet
ODD	Object to Detector Distance
PA	Posterior/Anterior
PANO	Panoramic
RF	Radio Frequency
ROI	Region of Interest
SID	Source to Image Receptor Distance
SIP	Signal Input Part
SOP	Signal Output Part
SMV	Submento-Vertical
SSXI	Solid State X-ray Imaging Device
STL	Stereo Lithography
TMJ	Temporomandibular Joint

Copyright by © 2020 VATECH Co., Ltd.

All rights reserved.

The documentation, brand name, and logo used in this manual are copyrighted.

No part of this manual may be reproduced, transmitted, or transcribed without the expressed written permission of the manufacturer.

We reserve the right to make any alterations that may be required due to technical improvement. For the most current information, contact your **VATECH** representative.

Tel: (+82) 1588-9510

Email: gcs@vatech.co.kr

Website: www.vatech.com

Headquarters: 13, Samsung 1-ro 2-gil, Hwaseong-si, Gyeonggi-do, 18449, Korea

Factory: 13, Samsung 1-ro 2-gil, Hwaseong-si, Gyeonggi-do, 18449, Korea



This is class IIb equipment and obtained CE marking in May 2017 for regulation compliance by the enacted European Union's MDR (Medical Device Regulation)



EC Representative: VATECH GLOBAL FRANCE SARL

49 Quai de Dion Bouton, AVISO A 4ème étage, 92800 Puteaux, France

Tel: +33 1 64 11 43 30

Fax: +33 1 64 11 43 39

Green X 12

ZIP Code : 18449
13, Samsung 1-ro 2-gil, Hwaseong-si, Gyeonggi-do, Republic of Korea
www.vatech.com

vatech