

EzRay Air™ Portable

vatech EzRay Air™ Portable User manual

EzRay Air™ Portable

User Manual

Model : VEX-P300

Version : 1.48

- English

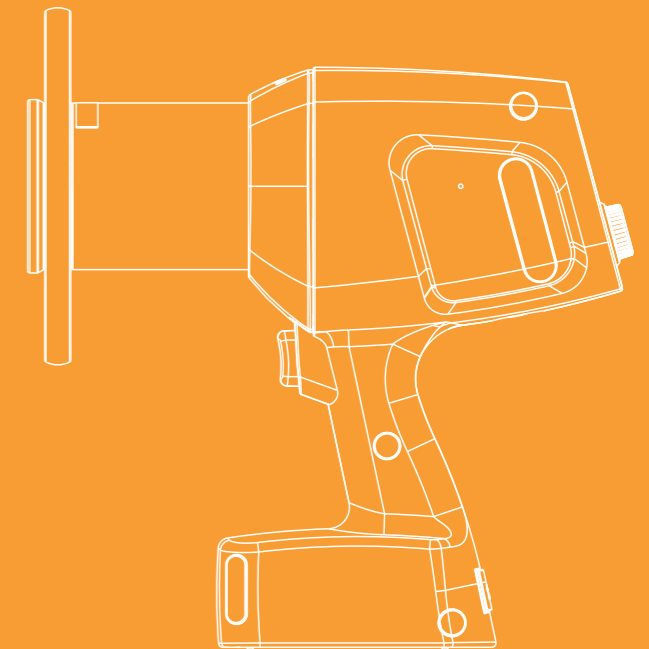

Full Version

Notice

The EzRay Air Portable (Model: VEX-P300) is a portable dental X-ray system.

This manual contains descriptions, operational instructions, imaging procedures for the EzRay Air Portable (Model: VEX-P300) dental X-ray system. It is recommended that you thoroughly familiarize yourself with this manual to make the most effective use of this device. Observe all cautions, safety messages, and warnings that appear in this manual.

Always keep this manual with the device and review the operating procedures and safety instructions if needed.

The illustrations/photos of the device in this manual are only for illustration purposes. The actual device may differ.

Due to continuous technological improvements, the manual may not contain the most updated information. For further information not covered in this manual, please contact us at:

VATECH Co., Ltd.

Phone: (+82) 1588 9510

E-mail: gcs@vatech.co.kr

This document is originally written in English.

The **EzRay Air Portable** is referred to as a **device** in this manual.

Manual Name: EzRay Air Portable (Model: VEX-P300) User Manual

Document number: VDH-UM-067

Version: 1.48

Publication Date: 2020-09



The EzRay Air Portable (Model: VEX-P300) unit is intended to be used by a **certified professional**, exclusively for dental radiography.

This page is intentionally left blank.

Table of Contents

Notice		v
Table of Contents		vii
1.	General and Regulatory Information	1
1.1	Manufacturer's Liability	1
1.2	Owner and Operator's Obligations	1
1.3	Conventions Used in this Manual	2
1.4	Marks and Symbols	3
1.5	Standards and Regulations	6
2.	Safety Instructions	7
2.1	General Safety Guidelines	7
2.2	Warnings and Safety Instructions	8
3.	System Overview	11
3.1	Indications for Use	11
3.2	Principles of Operation	11
3.3	Intended User Profile	11
3.4	Components	12
3.5	Features	13
3.6	General View of the Device	14
4.	Operation	19
4.1	Power On/Off	19
4.2	Enter Password	20
4.3	Operation Mode	21
4.4	Positioning	23
4.5	Exposure	32
4.6	Using the Battery	34
5.	Service Mode	43
5.1	Overview	43
5.2	Changing System Parameters	44

5.3	Service Mode Menu	47
6.	Troubleshooting	59
7.	Cleaning and Maintenance	63
7.1	Cleaning	63
7.2	Maintenance	64
8.	Disposing of the Unit	67
9.	Device Specifications	69
9.1	Mechanical Specifications	69
9.2	Technical Specifications	70
9.3	Electrical Specifications	74
9.4	Environmental Specifications	74
10.	Appendix	75
10.1	Combining the Holder and the devices using a tripod.....	75
10.2	Using the Rotating Rectangular Cover	77
10.3	Tables of Exposure Times (Default).....	79
10.4	X-ray Dose Data	83
10.5	Electromagnetic Compatibility (EMC) Information	92
10.6	Abbreviations	95

1. General and Regulatory Information

1.1 Manufacturer's Liability

The manufacturers and retailers of this device assume responsibility for the safe and normal operation only when:

- Always using genuine VATECH approved devices and parts.
- Performing all maintenance and repairs at a VATECH authorized distributor.
- Using this device properly following the user manual.
- The device damage or malfunction is not the result of an error on the owner or operator.



Disclaimer:

EzRay Air Portable (Model: VEX-P300) is sold with the understanding that the user assumes sole responsibility for radiation safety (as well as any state, provincial, or local regulatory compliance) and that **VATECH**, its agents or representatives, do not accept responsibility for:

- 1) any injury or danger to personnel from X-ray exposure,
- 2) image over/underexposure due to poor operating techniques or procedures,
- 3) device which has been damaged, modified, or tampered with in any way.

1.2 Owner and Operator's Obligations

- This device owner must perform constancy tests at regular intervals to ensure patient and operator safety. Local X-ray safety regulations must perform these tests.
- This device owner must perform regular inspection and maintenance of the mechanical and electrical components to ensure safe and consistent operation (IEC 60601-1).
- This device owner must ensure inspection and cleaning work is performed by the maintenance schedule outlined in **Chapter 7 Cleaning and Maintenance**.







DO NOT operate this device until reading this manual and reviewed the related materials.

1.3 Conventions Used in this Manual









The following symbols are used throughout this manual. Make sure that fully understand each symbol and follow the instructions which accompany it.

Please observe all warnings and safety information included in this document to prevent personal injury and damage to the device.









	<p>Indicates a potentially hazardous situation and improper handling may result in:</p> <ul style="list-style-type: none"> • Serious bodily injury (User or veterinary patient) • Substantial property damage
	<p>Indicates a potentially hazardous situation and improper handling may result in:</p> <ul style="list-style-type: none"> • Light injury • Property damage
	<p>Indicates a potentially harmful situation, and improper handling may result in:</p> <ul style="list-style-type: none"> • Property damage
	<p>Indicates a usage and other valuable information.</p>
	<p>Indicates a possible danger from radiation exposure.</p>

1.4 Marks and Symbols

The following table describes the purpose and location of safety symbols and other valuable information provided on the device.

Mark/Symbol	Description	Location
	Alternate current	Battery Charger Label
	Direct current	Main Label
	Attention: Consult accompanying documents	Main Label
	Dangerous voltage	Powerboard, X-ray Generator, Generator Label
OFF	Off (power: disconnect from the main switch)	Battery bay access door (outside)
ON	On (power: connect to the main switch)	Battery bay access door (outside)
	IEC60601-1 Degree of Protection from Electric Shock TYPE B Equipment	Main Label
	Radiation hazard	Generator Label
	Authorized European Representative address	Main Label
	The CE symbol indicates that this device complies with the European Directive for Medical Devices 93/42/EEC as amended by 2007/47/EC as a class IIb device.	Main Label
	UL mark No. E476672	Main Label

1. General and Regulatory Information

	Caution: Federal law restricts this device to sale by or about a licensed healthcare practitioner.	Main Label
	Manufacturer's name and address	Main Label, Generator Label
	Date of manufacture	Main Label, Generator Label
	This symbol indicates that electrical and electronic devices must not be disposed of as unsorted municipal waste and must be collected separately.	Main Label
	ESD susceptibility symbols indicate that an item is susceptible to damage from electrostatic discharges.	Board package
	Refer to the User Manual.	Main Label
	Using a Torx wrench, unscrew the battery bay access door.	Main Label
	Lift the door after the removal of the screw.	Main Label
	This symbol indicates the direction of cover attachment/detachment.	Cone's upper part

1.4.1 Label Locations

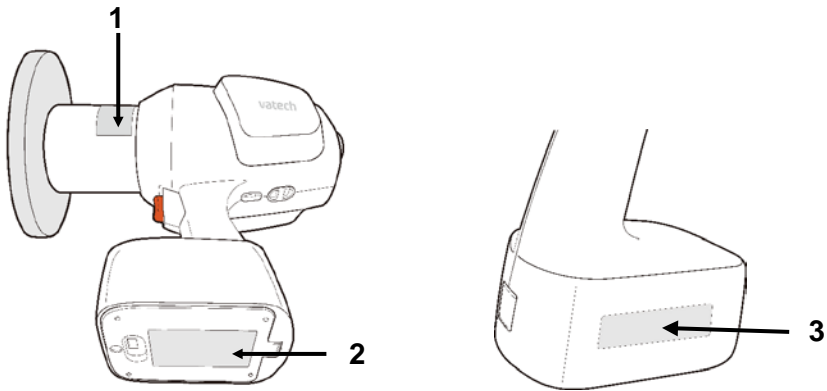

1. Generator Label

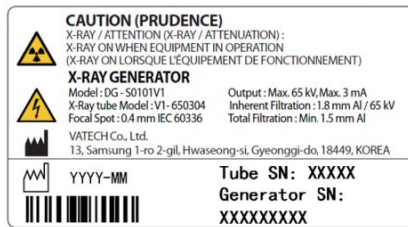

2. Main Label

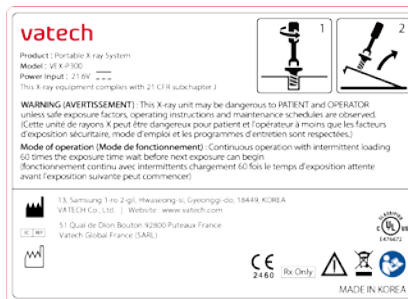

3. UDI Label

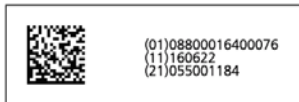

NOTICE



The labels' design and contents may be different in some countries based on local regulations and standards.

1.5 Standards and Regulations

Standards:

The device is designed and manufactured to meet the following standards:

- MEDICAL - APPLIED ELECTROMAGNETIC RADIATION EQUIPMENT
AS TO ELECTRICAL SHOCK, FIRE, AND MECHANICAL HAZARDS ONLY IN ACCORDANCE WITH
ANSI/AAMI ES60601-1 (2005) + AMD 1 (2012),
CAN/CSA-C22.2 No. 60601-1 (2014), IEC 60601-1-3 (2008), IEC 60601-2-65(2012)
- ISO 13485
- 21 CFR 1020.30 & 1020.31

 <p>CE 2460</p>	<p>This is Class IIb equipment and obtained CE marking in April 2007 for regulation compliance by the revised European Union's MDD (Medical Devices Directive) 93/42 EEC.</p>
 <p>CLASSIFIED UL E476672</p>	<p>This equipment received the UL certification mark in accordance with ANSI/AAMI, CAN/CSA-C22.2 No. 60601-1 regulations.</p>

Classifications (IEC60601-1 6.1):

Protection against the ingress of water: Ordinary Equipment (IPX0)

Protection against electric shock: Class II equipment,

Type B Applied Parts: Backscatter Shield, Round Cover, Rectangular Cover, Rotating Rectangular Cover



2. Safety Instructions

2.1 General Safety Guidelines



- This device is designed and manufactured to ensure the most significant safety of operation. Operate and maintain it in strict compliance with the safety precautions and operating instructions contained in this manual.
- Only a legally qualified person, i.e., a radiographer, diagnostic radiographers, medical radiation technologists, or healthcare professionals who specialize in imaging medical for the diagnosis and treatment of pathology, can operate this equipment in a controlled environment.
- Observe all local fire regulations. Always keep a fire extinguisher near the device.
- The device must be installed, maintained, and serviced by qualified service personnel according to the procedures and preventive maintenance schedules. Users can perform an only battery replacement.
- Ensure that the on/off switch is set to off when the device is not in use.
- Always disconnect the power supply before cleaning the device.
- DO NOT keep the device or its parts in a humid place or a liquid substance.
- Avoid placing the device near chemical storage and gas-filled storage facilities.
- The backscatter shield protects users from backscatter radiation that they might be exposed to during X-ray exposure. Operating the device with the backscatter shield allows the users to be exposed to less radiation than when operating without. For details on the scattering data of the device configured both with and without the backscatter shield, please review **10.4.3 Scattered Dose**.
- Wireless communication equipment is used no closer than 30 cm (12 inches) to any part of the **EzRay Air Portable(Model: VEX-P300)**, including cables specified by VATECH.





IMPORTANT

This device is shipped with the backscatter shield attached (firmly fixed), so users can not replace the backscatter shield. If it is damaged or defective, contact your Service Representative for replacement.

NOTICE

Mode of operation: **Non**-continuous operation with cyclic loading—This device needs a rest time of at least 60 times the exposure time before starting the next exposure.

2.2 Warnings and Safety Instructions

	<ul style="list-style-type: none"> • This X-ray unit may be dangerous to patients and operators unless safe exposure factors, operating instructions, and maintenance schedules are observed. It is essential to read this user manual carefully and strictly abide by all warnings and cautions stated. • To avoid the risk of electric shock, this device must only be connected to the supply main with protective earth. • Since rules and regulations concerning radiation safety differ between countries, it is the responsibility of the owner and operator of this device to comply with all applicable rules and regulations concerning radiation safety and protection in their area. • DO NOT open or remove the cover panels on this device. • Never expose this device to liquids, mists, or sprays. Exposing this device to liquids may cause an electrical shock or otherwise damage the system. • DO NOT use spray cleaners on this device, as this could cause a fire. • Never use this device in an environment that is susceptible to explosion. • DO NOT place flammable materials near this device. • Never touch the patient while also touching the SIP/SOP connectors. <p>The medical electrical device is subject to special EMC preventive measures. For more details, refer to 10.5 Electromagnetic Compatibility (EMC) Information.</p>
	<ul style="list-style-type: none"> • Patients and operators are encouraged to wear leaded protective lead-lined aprons unless other Radiation Protection Protocols are applied locally. • Children and pregnant women must consult with a doctor before X-ray exposure.
	<ul style="list-style-type: none"> • Never try to modify this device, including the wires or cables. Modifying this device may damage it beyond repair. • Serious dangers may occur from electromagnetic interference (i.e., noise) between other devices in the area during specific examinations or medical treatment.
	<p>Battery chargers must be in an accessible area where they can be easily unplugged from the power source.</p>

Battery Use

- Make sure to charge the battery in the external environment from the patient.
- Make sure to use the battery only provided or approved by VATECH. If non-standard or damaged batteries are used, there is a risk of fire and explosion.
- Make sure to use the battery charger only provided or approved by VATECH. Using an unauthorized charger may result in battery damage.
- DO NOT expose batteries to heat or fire. Avoid storage in direct sunlight.
- DO NOT short-circuit, crush, puncture, mutilate, or disassemble the battery.
- DO NOT store batteries haphazardly in a box or drawer where they may short-circuit each other or be short-circuited by other metal objects.
- Observe the plus (+) and minus (-) marks on the battery and device and ensure correct use.
- DO NOT subject batteries to mechanical shock.
- In a cell leaking event, do not allow the liquid to meet the skin or eyes. If the contact has been made, wash the affected area with copious amounts of water, and seek medical advice.
- Keep the battery away from children and pets.
- DO NOT make the battery wet or let it be in the water. Keep batteries clean and dry.
- Seek medical advice immediately if a battery has been swallowed.
- Make sure to turn off the device before replacing the battery.





- DO NOT remove a battery from its original packaging until required for use.
- DO NOT dispose of batteries with ordinary trash. Turn in discharged batteries to local supply or discard or recycle batteries according to your local government regulations.

IMPORTANT

- DO NOT leave a battery on a prolonged charge when not in use.
- If the device has not been used for long periods, it is recommended to charge the battery before use.
- After extended periods of storage, it may be necessary to charge and discharge the cells or batteries several times to obtain maximum performance.

IMPORTANT	<p>If the device not in use has been turned on for long periods, the battery may be fully discharged.</p> <ul style="list-style-type: none">- Depending upon the battery discharge status, it takes about 1 day for charging the battery. If the device is not turned on after charging the battery for about 1 day, it indicates that the battery has been fully discharged. Contact your Service Representative for battery replacement.- DO NOT charge a fully discharged battery, as this may cause fire or explosion. Be sure to replace the battery (provided by VATECH).
NOTICE	<ul style="list-style-type: none">• Users can replace batteries.• When charging the battery, the exposure function is locked.• Be sure to turn off the device when not in use. This helps to ensure the life of the battery.• Be sure to charge the battery frequently. This helps to ensure the life of the battery.

Radiation Safety

 WARNING	<ul style="list-style-type: none">• When using the device, it is recommended that all users comply with the following radiation safety guidelines for the users and the patients' safety.
 RADIATION HAZARD	<ul style="list-style-type: none">• All users and patients should wear a protective device, such as a lead apron, thyroid collar, etc.• This device should be operated in an area that is more than 6 feet away from other personnel, such as assistants or other patients. If they should stay closer than 6 feet, it is recommended that they wear a lead apron, thyroid collar, or stay behind a lead shield.• Pregnant women should not be exposed to X-rays unless it is strictly necessary.• All users should comply with the Radiation Protection Policies established by the government.• When selecting a Position Indicating Device, it should be considered if the PID can be used with the backscatter shield attached at the cone's outer end for most operator protection.

3. System Overview

The device, a portable dental X-ray system, operates on 21.6 Vdc supplied by a rechargeable Li-ion battery pack. The portable X-ray system is an X-ray generating device designed for dental examination (teeth and jaw). The portable X-ray system is composed of an X-ray generating part with an X-ray tube including a device controller, a power controller, a user interface, a beam limiting part, a backscatter shield, and an optional Remote Exposure Switch. The device is designed to diagnose teeth and jaw through X-ray exposure using intra-oral image receptors.

3.1 Indications for Use

EzRay Air Portable (Model: VEX-P300) is an extraoral diagnostic dental X-ray source to produce X-ray images using intraoral image receptors. It is indicated for use by a dentist or a dental technician for both adult and pediatric patients.

3.2 Principles of Operation

X-rays are emitted when a high voltage is supplied to the X-ray tube assembly, which frees electrons from the cathode. They hit anode to produce X-rays. The device acquires images by emitting X-rays continuously on the human tooth.

3.3 Intended User Profile

Considerations	Requirement Description
Education	A licensed dentist or dental hygiene, radiologist, and graduates of relevant bachelor's degree (national qualifications)
Knowledge	The operator must have understood: <ul style="list-style-type: none"> • treatment and diagnosis of dental disease • terms and guidance of diagnostic medical radiation devices • device connection, installation, and operating conditions.
Language understanding	The operator must have understood: <ul style="list-style-type: none"> • the English or Korean manuals (or other languages provided).
Experience	The operator must have understood: <ul style="list-style-type: none"> • objectives and effects of treatment and diagnosis of dental disease using diagnostic medical radiation devices • normal operation of diagnostic medical radiation devices • the contents of the user manual.

3.4 Components

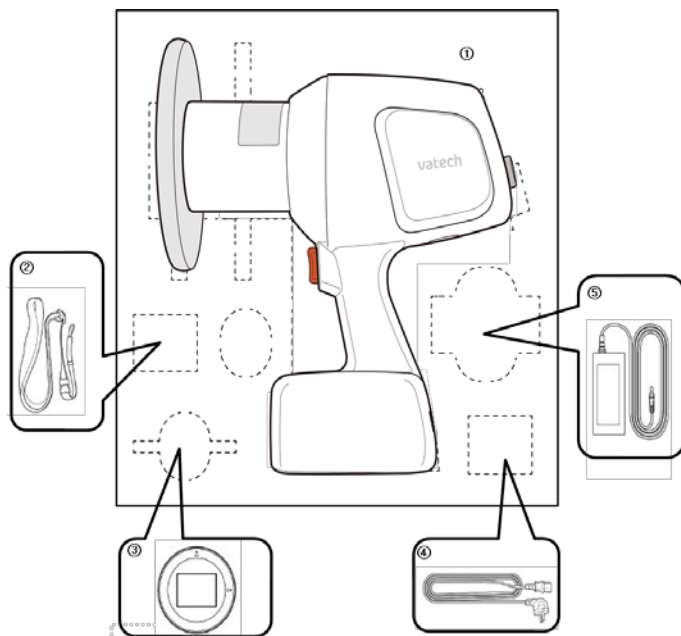

No.	Item	Standard	Option	Qty.
1	Main Body (included the Backscatter Shield and the Round Cover)	•		1
2	Hand/Neck Strap	•		1
3	Rectangular Cover (4x3)	•		1
4	power cord	•		1
5	Battery Charger	•		1
6	User Manual	•		1
7	Cradle		•	1
8	Rectangular Cover (2x3)		•	1
9	Rotating Rectangular Cover (4x3)		•	1
10	Rotating Rectangular Cover (2x3)		•	1
11	Remote Exposure Switch		•*	1
12	Base Holder		•*	1
13	Tripod		•*	1

**Read the notice on the next page for the options with the symbol (*)

NOTICE

The remote exposure switch, base holder, and tripod are provided with **EzRay Air Portable (Model: VEX-P300)** for users in the countries where a hand-held X-ray device is prohibited in the clinic. For more information, please contact a VATECH representative in your area.

3.5 Features

The device is an intra-oral portable X-ray system that offers safety, reliability, and greater functionality:

- Lightweight and ergonomic design
- The convenience of cordless design by using battery-pack
- Micro-computer and a specialized circuit that monitors and precisely regulates the exposure technique factors (kV, mA, and exposure time)
- Pre-programmed exposure time makes the operation fast and easy.
- A selection of phosphor plates or digital sensors





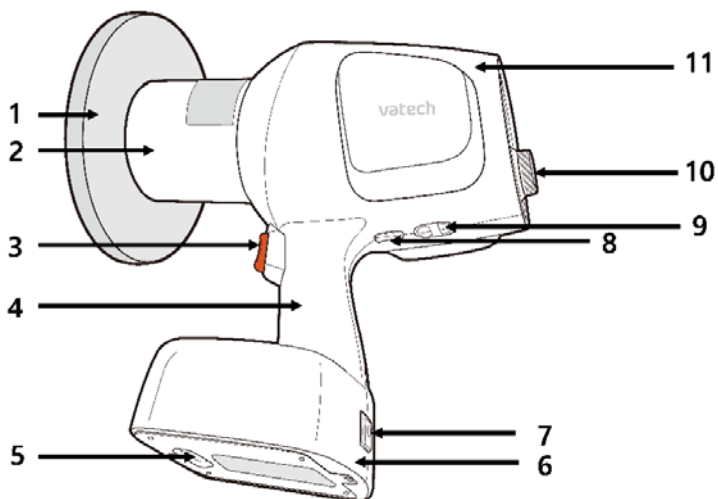

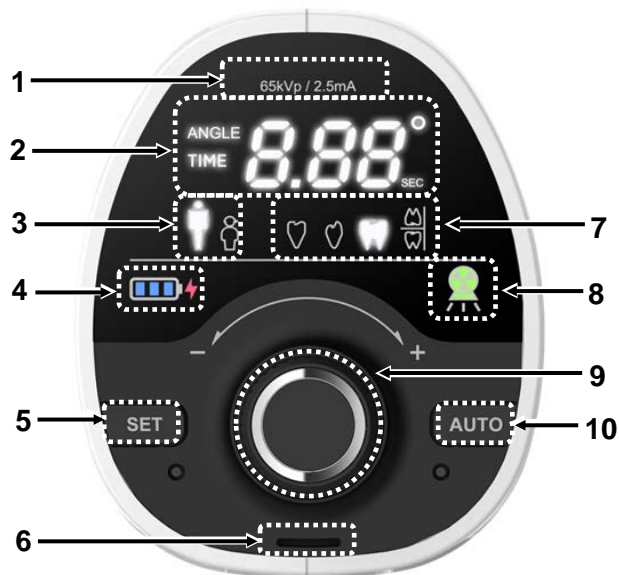

3.6 General View of the Device

Main Body





No.	Item	Description
1	Backscatter Shield	Shields from the backscattering radiation.
2	X-ray Beam Limiting Device	Limits the X-ray exposure area. Default type: Round Cone + Round Cover (FOV: Ø 6 cm)
3	X-ray Exposure Button	Press the button for X-ray exposure.
4	Handle	Grip the handle securely when using the system.
5	Power Button	Power On/Off button
6	Battery	Rechargeable Lithium-ion battery
7	Adaptor Connector	Connect the charging adaptor.
8	Remote X-ray Exposure Switch Port	Connect the X-ray exposure cable switch. Alternatively, it can be used as a service port
9	Strap Loop	Connect the strap.
10	Control panel	Display for the X-ray exposure settings and operation conditions
11	X-ray Generator	Includes the X-ray tube and the high-voltage generator.

Control panel

No.	Item	Description
1		Tube Voltage/Current Indicator Indicates the tube voltage and tube current of the system.
2		Angle/Time Display Displays the X-ray exposure time, error code, cooling time, and exposure angle.
3		Adult/Child Selection Indicates a patient type (adult or child).
4		Remaining Battery Indicator Indicates remaining battery level.
		Battery Charging Indicator 1) Indicates that the battery charger is connected to the device. 2) Indicates the battery needs to be charged when it flickers .
5		SET Button Resets the X-ray exposure angle.
6		Speaker Sound alarm for the X-ray exposure
7		Tooth Type Selection Selects the tooth type.

3. System Overview

8		X-ray Exposure Indicator	Indicates the X-ray exposure status. (Green: Ready / Yellow: X-ray On)
9		Jog Dial	Turn the jog dial left (-) or right (+) to select an X-ray exposure setting, press the jog dial to confirm the operating setting.
10		AUTO Button	Available only in countries that allow the auto mode for use. The mode is not available in the United Kingdom, the United States, and some countries. (Consult the sales representative in your country for details) In these countries, only "NA" is displayed on the panel when this button is pressed.

Available Option Items

No.	Figure	Option name
1	A white rectangular cover with an orange border and a central white square.	Rectangular Cover 2x3 (3x2) FOV: 2x3 cm, 3x2 cm (This cover can be used as both 2x3 and 3x2.)
2	A white rectangular device with a red button and a cable.	Remote Exposure Switch
3	A white rectangular cover with an orange border and a central white square.	Rotating Rectangular Cover 4x3 (3x4) FOV: 4x3cm, 3x4cm (This adaptor can be used as both 4x3 and 3x4.)
4	A white rectangular cover with an orange border and a central white square.	Rotating Rectangular Cover 2x3 (3x2) FOV: 2x3cm, 3x2cm (This adaptor can be used as both 2x3 and 3x2.)
5	A white metal base holder with a blue vertical rod.	Base Holder*
6	A white cradle with a curved top and a flat base.	Cradle
7	A black tripod with three legs and a central column.	Tripod

* In case a tripod is used with the Base Holder, refer to the specifications below.

- Fixing bolt size: 3/8 inch
- Maximum supportable weight: about 5 kg
- Minimum height: > 130 cm
- More than 3 columns are required.
- When using a tripod with 3 columns, make sure to have space of at least 1 min-width on the bottom.

NOTICE

Refer to **Appendix 10.2 Using the Rotating Rectangular Cover** for instructions for use.

4. Operation

4.1 Power On/Off

1. Turn on the system referring to the following figure.

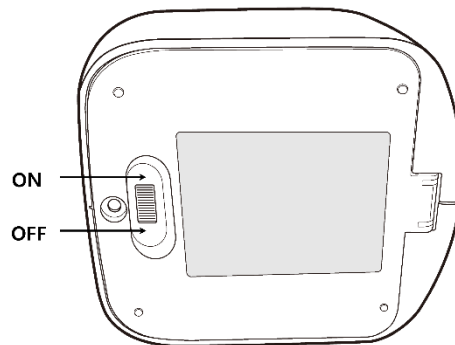

2. The following displays and indicators light up:
 - Current Angle/Time display
 - Tooth type selection display
 - Adult/Child selection display
 - Remaining battery indicator
 - X-ray exposure indicator
3. Make sure that at least one battery indicator light comes on.



Battery level 1

NOTICE

When the battery indicator has one flickering light, charge the battery immediately by using the battery charger.

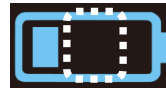

For more information, refer to **4.6 Using the Battery**.

4.2 Enter Password

NOTICE

To turn on or off the password mode, refer to **5.3.4. Password mode On/Off**.

To change the password, refer to **5.3.11. Password Setting**.

1. Enter the 3 digits numeric password using the jog dial. (default password: 000)



2. Turn the jog dial to choose a number and press the dial to move to the next digit.



3. When all three digits are set, press the jog dial again to save the setting.

4.3 Operation Mode

This system can be operated in Manual Mode.

Manual Mode

- When the tooth type selection area flickers, turn the jog dial to select the tooth type. To see the Control panel before and after selection, refer to the figures below.





Before tooth type selection



After tooth type selection



Tooth Type



Symbol	Type
	Incisor
	Canine
	Molar/Premolar
	Bitewing

- After tooth type selection, a patient type should be selected. When the Adult/Child selection area flickers, turn the jog dial to select the patient type. To see the Control panel after selection, refer to the figure below.

After patient type selection



Patient Type

Symbol	Type
	Adult
	Child

NOTICE

After the tooth type and patient type are selected, the exposure time is automatically displayed.

- When changing the exposure time, turn the jog dial to adjust the exposure time from 0.05 to 1.0 s. (increments: 0.01 s)

NOTICE

When pressing the jog dial after adjusting the exposure time in Manual Mode, the exposure time is returned to the default setting.

To save the exposure time as default in Manual Mode, press and hold the jog dial for about 3 seconds.

4.4 Positioning

Positioning the Patient

To obtain high-quality intra-oral radiography with maximum details, take extra care in all steps of the radiography process: positioning the patient and the X-ray imaging system; exposing the phosphor plate or the intra-oral sensor.

1. Place a protective lead apron on the patient's chest.
2. Have the patient sit on the chair with the sagittal plane vertical.
 - For radiography of the upper maxillary, the Frankfort plane must be horizontal.

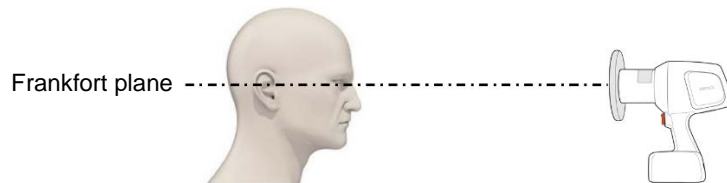

- For radiography of the lower maxillary, the Occlusal plane must be horizontal.

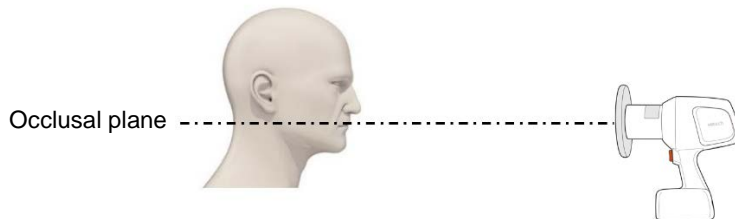

3. Place the tube head cone in the area want to take an image.
 - 1) When using the device as a hand-held

When holding the device, it is recommended to grip the handle by one hand and place the other on the underside of the device, as shown in the following figure.

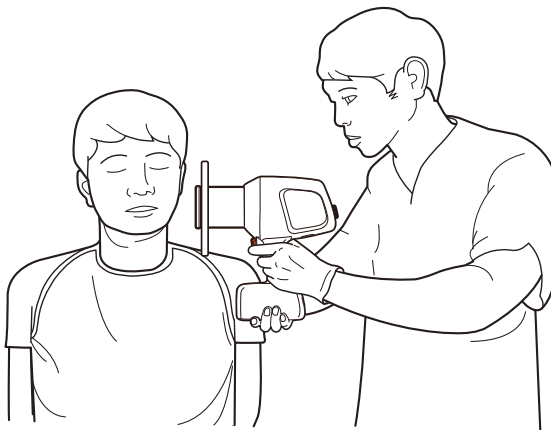

- 2) When using the device with a tripod

If you are in a country that does not allow using a hand-held X-ray in the clinic, use the device with a tripod, base holder, and remote exposure switch. To learn the proper use of each of these components, see **4.5.1 Remote Exposure Switch** and **10.1 Combining the Holder and the device using a tripod**.

NOTICE

Depending on the imaging angles, exposure times vary. Since it is necessary to keep the patient with low X-ray doses and the user in the protected area, have the patient's head slightly tilted, and raise or lower the chin if needed. Please refer to **2.2 Warnings and Safety Instructions**.

For further information about the patient positioning and beam angle for each mode, refer to the following **Positioning Instructions**.

Positioning Instructions

Paralleling technique: The phosphor plate or sensor is placed in a holder used to align the phosphor plate or sensor parallel to the tooth's long axis.

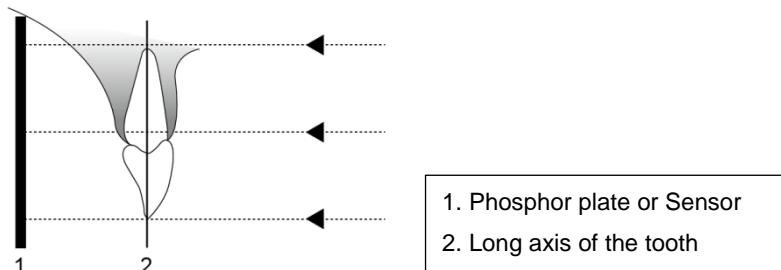

Bisected angle technique: The patient holds the phosphor plate or sensor in place with his/her finger. The X-ray beam is directed perpendicularly towards an imaginary line, which bisects the angle between the phosphor plate or sensor plane and the tooth's long axis.

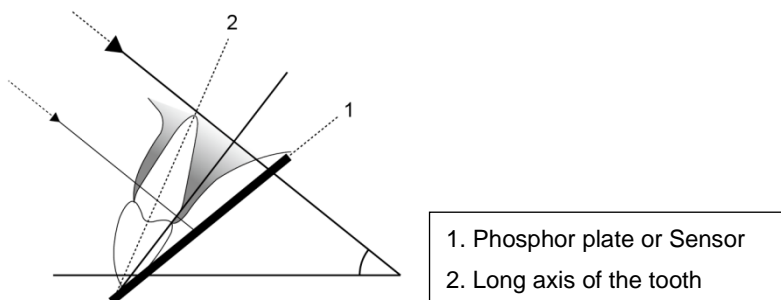

Position the tube head to the patient using the accepted standard positioning procedures.

Here are the specific angulations and directions for the tube head to take the best images of a tooth (i.e., **Bisected angle technique**).



Position the receptor carefully not to damage the soft tissue of the patient's intra-oral area.

- **Maxillary Incisor**

The x-ray beam is directed downward at 45°.

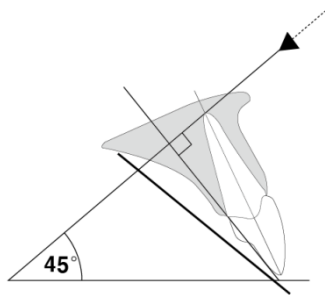

Teeth		Angle of inclination
Incisor	Maxilla	+45°

- **Mandibular Incisor**

The x-ray beam is directed upward at 25°.

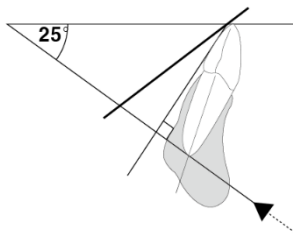

Teeth		Angle of inclination
Incisor	Mandible	-25°

- **Maxillary Canine**

The x-ray beam is directed downward at 45°.

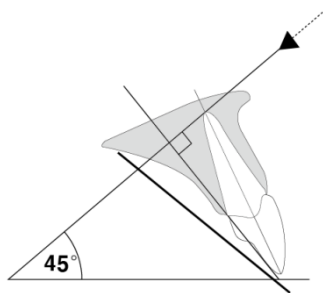

Teeth		Angle of inclination
Canine	Maxilla	+45°

- **Mandibular Canine**

The x-ray beam is directed upward at 20°.

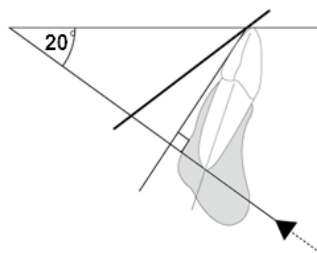

Teeth		Angle of inclination
Canine	Mandible	-20°

- **Maxillary Molar and Premolar**

The x-ray beam is directed downward at 30°.

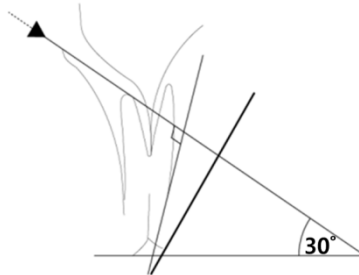

Teeth		Angle of inclination
Molar and Premolar	Maxilla	+30°

- **Mandibular Molar and Premolar**

The x-ray beam is directed upward at 5°.

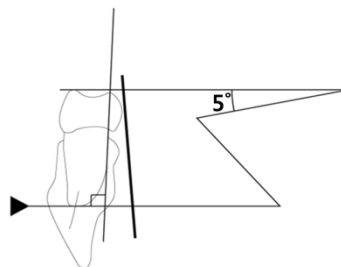

Teeth		Angle of inclination
Molar and Premolar	Mandible	-5°

- **Bitewing**

For a bitewing exposure, the patient closes their teeth during exposure on the phosphor plate/sensor holder.

The x-ray beam is directed downward at $5^{\circ} \sim 8^{\circ}$

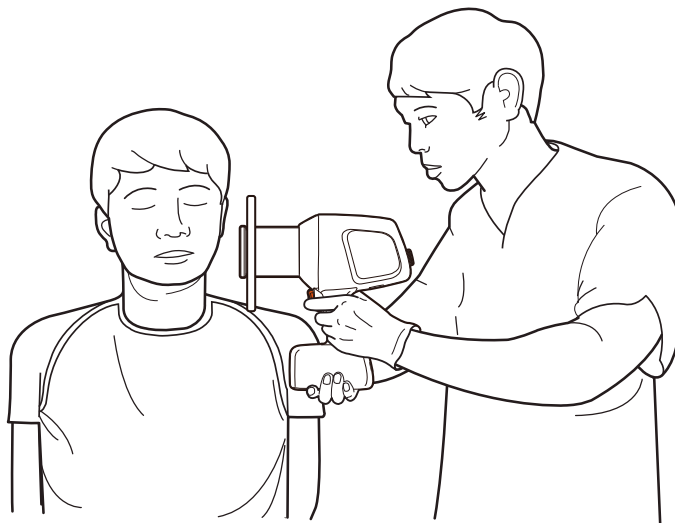

Teeth	Angle of inclination
Bitewing exposure	$+5^{\circ} \sim +8^{\circ}$

Positioning the Imaging Sensor

Using **EzRay Air Portable (Model: VEX-P300)**, a portable dental X-ray system, you may create an X-ray image on different types of imaging receptors:

- Digital sensors
- Phosphor plate

To ensure image quality, the digital imaging sensor must be appropriately positioned (for information about the imaging sensor's proper placement, please refer to 'Positioning Instructions.')

- Failure to position the imaging sensor correctly can result in errors on the radiograph, such as distorted teeth and roots, elongation, magnification, and overlapping contacts.

NOTICE

The paralleling technique generally reduces the risk of such errors, but if the sensor's position is improper, angulation errors may occur (angulation of the sensor to the tooth itself).

- Failure to align the imaging sensor with the X-ray beam's exit pattern can result in cone-cuts on the radiograph. The cone-cuts are bright areas shown on the radiograph when part of the radiograph is not exposed to radiation. Please refer to the following figure as an example of cone-cuts.

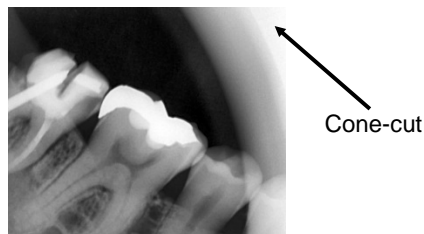

The following figure indicates how the cone-cut occurred by showing the imaging sensor's position and the radiation area.

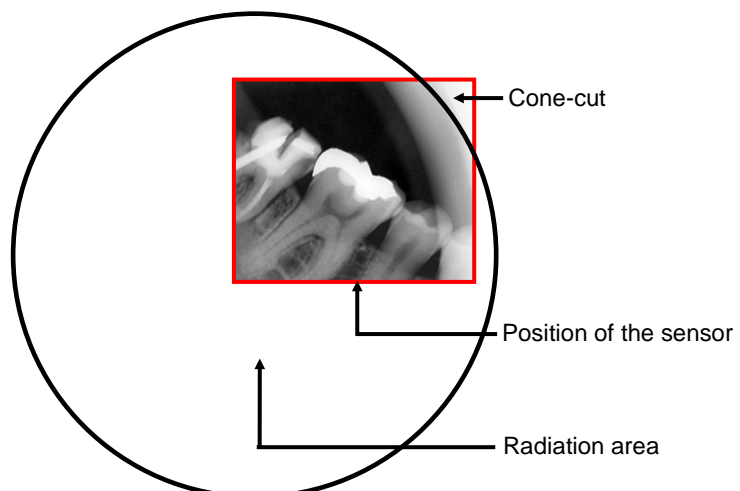

To ensure proper alignment between the imaging sensor and the X-ray beam, it is recommended to use a PID (Position Indicating Device), as shown in the following figure.

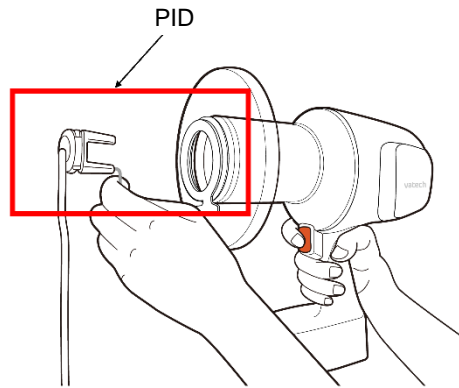

When using the PID, the X-ray device's exit pattern should be aligned perpendicular to the target receptor, as shown in the following figure.

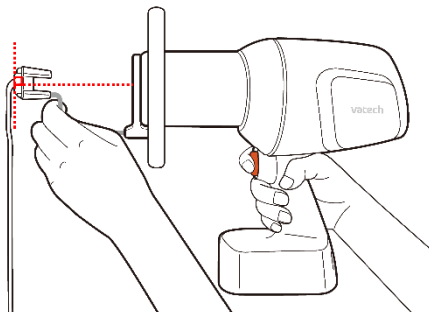
**NOTICE**

Once the PID is appropriately aligned, instruct the patient not to move.

4.5 Exposure

IMPORTANT

The operator **MUST** instruct the patient to refrain from moving during the entire exposure.

1. Instruct the patient not to move.
2. Press the Exposure Button for exposure duration.

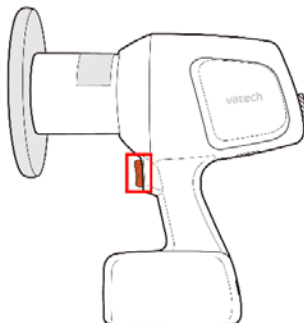

IMPORTANT

The operator in the countries where a hand-held X-ray device is prohibited must use a **remote exposure switch**.
See 4.5.1 Remote Exposure Switch for details.

3. While X-ray is being exposed,
 - The X-ray Exposure Indicator lights up, and an audible sound is produced.
 - Keep pressing until the X-ray Exposure Indicator light goes out, and the audible sound stops.



Green: Ready



Yellow: X-ray On

IMPORTANT

Hold the Exposure Button or switch if the acoustic signal can be heard. Otherwise, the exposure will be faulty, and there will be an error message on the Control panel.

4.5.1 Remote Exposure Switch

The **Remote Exposure Switch** allows the operator to control image acquisition from outside of the X-ray room.

Press and hold the **Remote Exposure Switch** until the acquisition is completed. Premature release of the **Remote Exposure Switch** will abort image acquisition.

Pressing the **Remote Exposure Switch** activates the X-ray Exposure Indicator to turn yellow. This color indicates that the X-ray is being emitted.

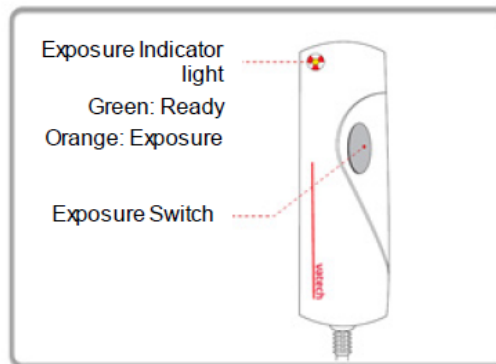

IMPORTANT

The **Remote Exposure Switch** is detachable. Ensure that the **Remote Exposure Switch** cable is not detached out from the unit accidentally during the operation.

IMPORTANT

Keep vocal/visual contact with the patient during exposure. If any problem occurs during exposure, release the **Remote Exposure Switch** immediately.

4.6 Using the Battery

The battery level indicator with a residual quantity is shown on the left side of the Control panel. When the battery indicator has one flickering light (level 1), charge the battery immediately. The figure below shows each battery indicator from level 1 to 3



Level 3

Level 2

Level 1

When the battery reaches Level 1, charge the battery at least for an hour to avoid a low voltage. All displays are turned off under the low voltage except for the error code **A.10**, as shown (see the figure below).

After the device is connected to the battery charger, and the battery level becomes 'Level 1', all functions are returned to normal operation.

IMPORTANT



System Status depending on Battery Levels

Item		System Status			
		Battery Level 3, 2	Battery Level 1		Low Battery
When turning on the system	Operation	Normal	Normal	Normal	Not operated
	Battery Level Indicator	Normal	Normal	Flickers	Not displayed
	Battery Charging Indicator	Not displayed	Not displayed	Flickers	Not displayed
	Control panel Brightness	Normal	Normal	Dark	Normal (Error code A.10 is only displayed)
When operating the system	Operation	Normal	Normal	Normal	Not operated
	Battery Level Indicator	Normal	Normal	Flickers	Not displayed
	Battery Charging Indicator	Not displayed	Not displayed	Flickers	Not displayed
	Control panel Brightness	Normal	Normal	Normal	Normal (Error code A.10 is only displayed)



Make sure to charge the battery if the Battery Charging Indicator flickers (or the error code A.10 is displayed). If the device has been turned on for long periods with the error code A.10, the battery may be discharged.



DO NOT charge a fully discharged battery, as this may cause fire or explosion. Be sure to replace the battery (provided by VATECH).



When the device is connected to the battery charger, the Battery Charging Indicator is always displayed except that the battery is fully discharged.

Charging the Battery

1. Connect the battery charger to the battery charger connector, as shown in the following figure.

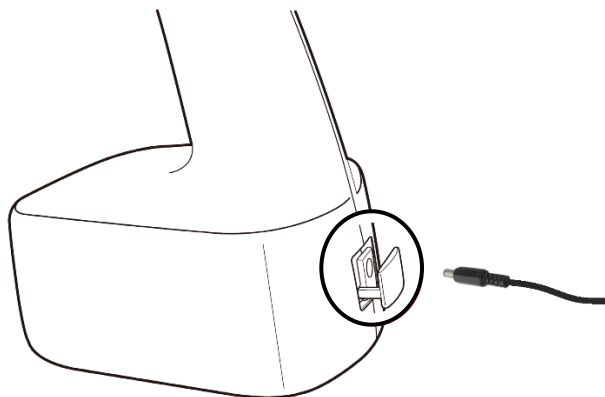

2. When the battery charger is connected, the battery charging LED indicator light comes on. Charge the battery until all the three LED indicators are filled up.

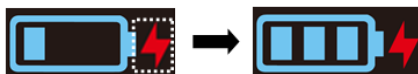

NOTICE

Usually, it takes about 3 hours to charge the battery after a complete discharge fully.

3. When the battery charge is completed, remove the battery charger from the device.

NOTICE

It is not able to perform an exposure while the battery charger is connected to the device.

Battery Use Cycle

The battery is a consumable part. It is expected to degrade gradually, so it should be recharged more frequently. When the battery duration decreases to half or less than half compared to when the battery was new, contact your Service Representative to get a new battery.

To check how to replace the battery, see 'Battery Replacement.'

Battery Replacement

NOTICE

Users can replace batteries. To replace the battery, contact your Service Representative to get a battery kit (including a new battery and a Phillips screwdriver).

1. Workforce
One person, 3 minutes
2. Tools required
Phillips screwdriver (size: T20)
3. Removal Procedure
 - 1) Using a Phillips screwdriver, unscrew the battery bay access door.

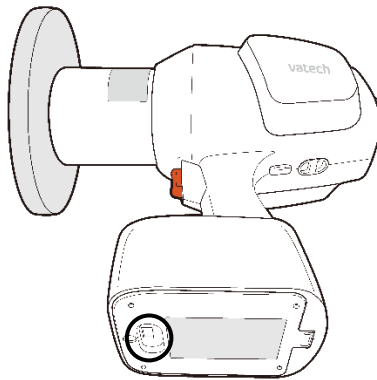

- 2) Lift the door and remove the battery.

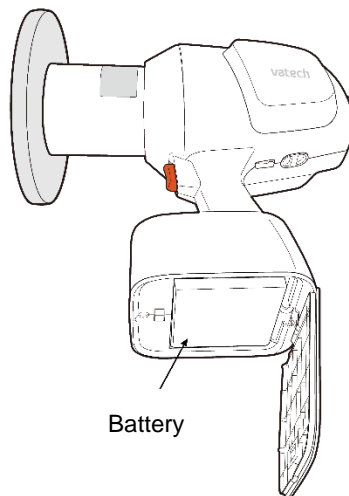

- 3) Disconnect the device's battery cable by pressing the battery cable connector, as shown in the following figure.

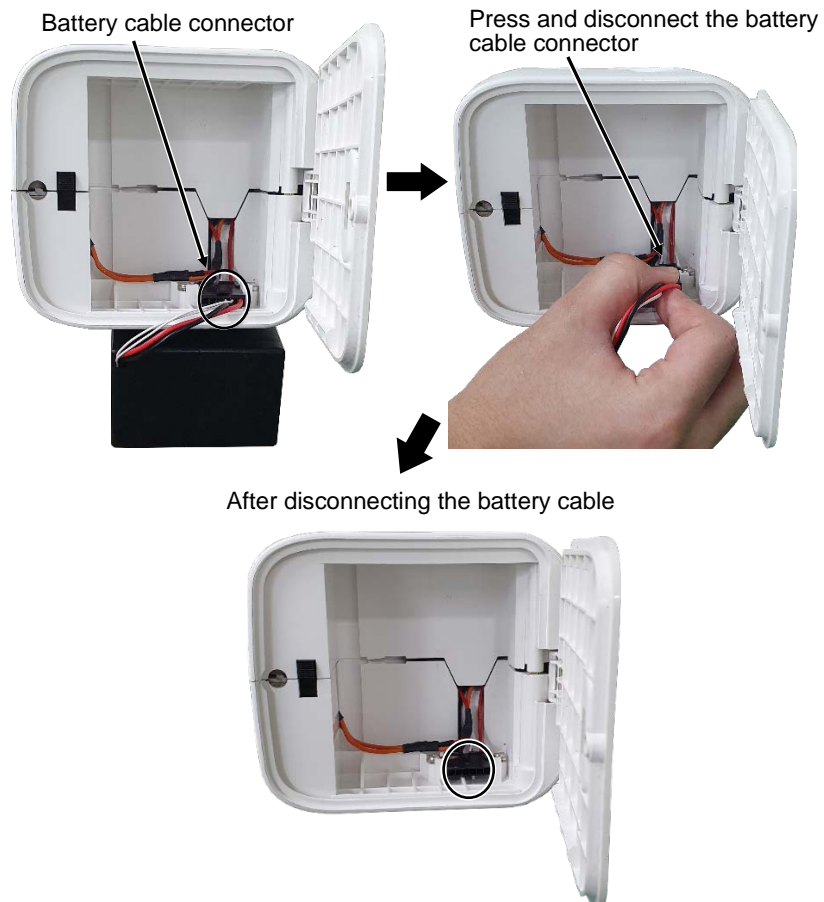

DO NOT pull excessively on the battery cable.

- 4) Install the new battery in the reverse order of removal.

Sleep Mode 1

To minimize battery consumption, Sleep Mode 1 starts when the device stays inactive for one minute (To learn how to change the default waiting time for Sleep Mode 1, see **5.3.6 Waiting Time Setting for the Sleep Mode 1**).

1. When Sleep Mode 1 starts, the Control panel becomes lightly dark, as shown in the right figure.



Brightness: Normal

Brightness: Lightly dark

2. To return to normal operation, press any button on the device (except for the **X-ray Exposure Button**).

NOTICE

When the device is not in use, turn off the power to avoid battery consumption.

Sleep Mode 2

Sleep Mode 2 starts when the device stays inactive for 5 minutes after entering Sleep Mode 1 (To change the default waiting time for Sleep Mode 2, see **5.3.7 Waiting Time Setting for the Sleep Mode 2**).

IMPORTANT

If the battery charger is connected to the device, Sleep Mode 1 is maintained.

1. When the Sleep Mode 2 starts, all displays are turned off on the Control panel, as shown in the right figure.

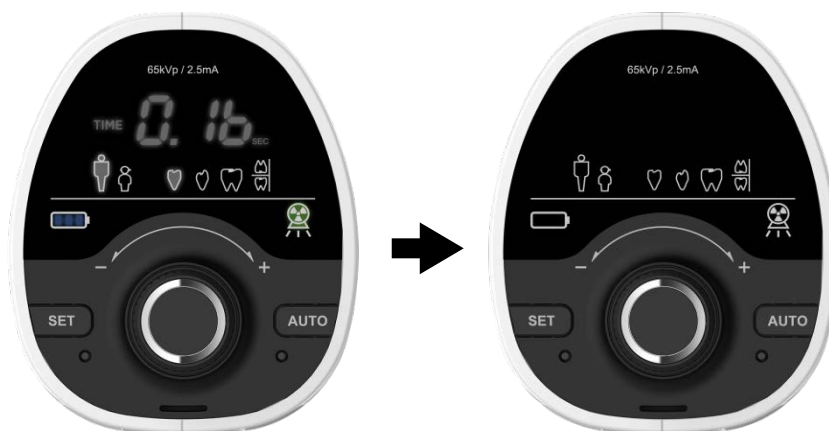

Brightness: Lightly dark

Brightness: Dark

2. To return to normal operation, press any button on the device (except for the **X-ray Exposure Button**).

NOTICE

When the device is not in use, turn off the power to avoid battery consumption.

Power Down Mode

When the device stays inactive for 5 hours after entering Sleep Mode 2, the Power Down Mode starts. (To change the default waiting time for the Power Down Mode, see [5.3.8 Waiting Time Setting for the Power Down Mode](#)).

IMPORTANT

If the battery charger is connected to the device, Sleep Mode 1 is maintained.

1. All displays are turned off on the Control panel.



2. To return to normal operation in the Power Down Mode, **MUST** turn off the system and turn it back on.

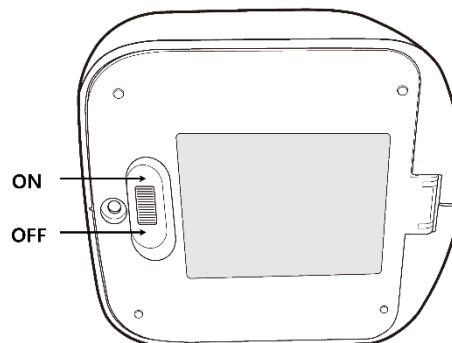

NOTICE

Refer to [5.3.10 Power Down Mode On/Off](#) to disable the mode.

This page is intentionally left blank

5. Service Mode

5.1 Overview

In the Service Mode, users can check and change the following settings:

- 5.3.1 Factory Default Settings
- 5.3.2 Exposure Time Settings
- 5.3.3 User Default Settings (for each patient and tooth type))
- 5.3.4 Password Mode On/Off
- 5.3.5 Angle Increments Setting
- 5.3.6 Waiting Time Setting for the Sleep Mode 1
- 5.3.7 Waiting Time Setting for the Sleep Mode 2
- 5.3.8 Waiting Time Setting for the Power Down Mode
- 5.3.9 Buzzer On/Off
- 5.3.10 Power Down Mode On/Off
- 5.3.11 Password Setting

5.2 Changing System Parameters

To change system parameters:

1. Press and hold the **SET button** and **jog dial** simultaneously (for about 3 seconds).



2. Enter the 3 digits numeric password using the jog dial. (default password: 000)



3. Turn the dial to choose a number and press it to move to the next digit.



4. When all three digits are set, press the **jog dial** again to save the setting.
5. After entering the password is completed, the service mode starts, as shown in the figure below.



6. The system provides **24** service modes. To change each mode's settings from **n.01** to **n.24**, press the **AUTO** button on the left. Upon pressing the button, n.01 is displayed on the control panel.

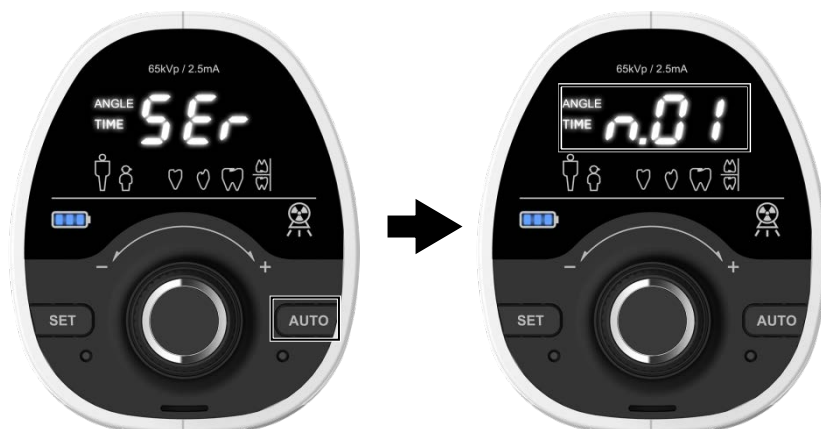

5. Service Mode

7. To move to the next mode, press the **AUTO button** again. Each time you press the button, the service mode number goes up by one. To return to the previous mode, press the **SET button** on the right. (See **5.3 Service Mode Menu** to learn more information on each mode)
8. Each time you finish changing the system parameter, press the **jog dial** and hold it until you hear a beep.



9. To resume the operation, press the **SET button** and the jog dial simultaneously and hold them for about 3 seconds.



10. Restart the device to check if the change is saved correctly

5.3 Service Mode Menu

See 5.2 Changing System Parameters for entering each service mode.

5.3.1 Factory Default Settings

Factory default settings restore all system mode parameters to their default values except for n.24. Follow the procedures below to activate the settings.

Service Mode No.	Item
n.01	Factory default settings

To restore the system to the factory default settings,

1. Select **n.01** and press the jog dial. When the message “**YES**” is displayed on the control panel, the system is restored to its initial settings.



2. To save the setting, press the jog dial and hold it until you hear a beep.
3. Restart the device to check if the factory default setting is on.

5.3.2 Exposure Time Settings (for each patient and tooth type)

Select a service mode from **n.02** to **n.09** to set up an exposure time for each patient and tooth type. See the table below for more information.

Service Mode No.	Item
n.02	Adult Incisor
n.03	Adult Canine
n.04	Adult Molar/ Premolar
n.05	Adult Bitewing
n.06	Child Incisor
n.07	Child Canine
n.08	Child Molar/ Premolar
n.09	Child Bitewing

To set the exposure time for a specific patient and tooth type as described above,

1. Select the Service Mode number according to the patient and tooth type (i.e., **n.06** for Child Incisor)



2. After entering the mode, turn the jog dial to adjust the exposure time.
3. Press the jog dial again and hold it until you hear a beep.
4. Restart the device to check if the new setting is saved.

5.3.3. User Default Settings (for each patient and tooth type)

User default settings are activated as the device starts. See the table to change each service mode number aligned with the patient or tooth type.

Service Mode No.	Item
n.10	Adult
n.11	Child
n.12	Incisor
n.13	Canine
n.14	Molar/Premolar
n.15	Bitewing

To set the default setting for a specific patient type or a tooth type,

1. Select a service mode number between **n.10** (Adult) and **n.11** (Child) for a specific patient type and from **n.12** to **n.15** for a tooth type. For instance, when select **n.10** by pressing the jog dial to set the patient type 'adult' as default, then "YES" is displayed on the Control panel.

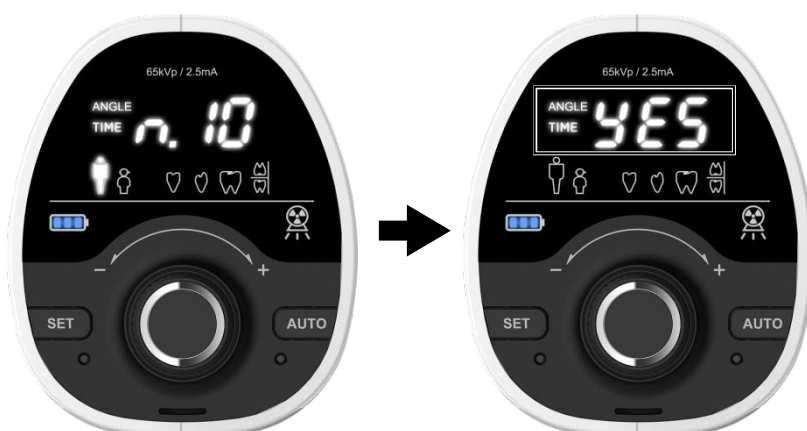

2. Press the jog dial again and hold it until you hear a beep.
3. Restart the device to check if the new setting is saved correctly.

5.3.4 Password Mode On/Off

Follow the procedure below to turn on and off the password mode.

Service Mode No.	Item
n.16	Password On
n.17	Password Off

To activate the password mode,

1. Select **n.16** and press the jog dial. The message “**YES**” is displayed on the Control panel.



2. Press the dial again and hold it until you hear a beep.
3. Restart the device to check if the setting is saved correctly.
4. To deactivate the password mode, select **n.17**, and repeat the procedure.

5.3.5 Angle Increments Setting

IMPORTANT

Available only in countries that allow the auto mode for use. The mode is not available in the United Kingdom, the United States, and some countries (Consult the sales representative in your country for details). When the auto button is pressed, only "NA" is displayed on the panel.

Follow the procedure below to set up the angle increments for the **Auto Mode**.

Service Mode No.	Item
n.18	Angle increments setting

When using the Auto Mode, the angle value increases and decreases according to the increments setting (default: 1 degree).

The angle increments can be set **from 1 to 5 degrees**.

To change the angle increments setting,

1. Select **n.18** and press the jog dial. The default angle increments "001°" is displayed on the control panel, as shown in the right figure.



2. Turn the jog dial to adjust the angle increments you want.
3. Press the dial again and hold it until you hear a beep.
4. Restart the device to check if the setting is saved correctly.

5.3.6 Waiting Time Setting for the Sleep Mode 1

Follow the procedure below to set up the waiting time for Sleep Mode 1.

Service Mode No.	Item
n.19	Waiting time setting for the Sleep Mode 1

To change the waiting time for **Sleep Mode 1**

1. Select **n.19** and press the jog dial. The default time “**001**” (1 minute) is displayed on the control panel, as shown in the right figure.



2. Turn the jog dial to the right to change the time (The selection is available from **1 to 999** minutes).
3. Press the dial again until you hear a beep.
4. Restart the device to check if the new setting is saved correctly.

5.3.7 Waiting Time Setting for the Sleep Mode 2

Follow the procedure below to set up the waiting time for Sleep Mode 2.

Service Mode No.	Item
n.20	Waiting time setting for the Sleep Mode 2

To change the waiting time for Sleep Mode 2,

1. Select **n.20** and press the jog dial. The default time “**005**” (5 minutes) is displayed on the control panel, as shown in the right figure.



2. Turn the dial to change the default time (The selection is available from **1 to 999** minutes).
3. Press the dial again and hold it until you hear a beep
4. Restart the device to check if the new setting is correctly saved.

5.3.8 Waiting Time Setting for the Power Down Mode

Follow the procedure below to set up the waiting time for the Power Down Mode.

Service Mode No.	Item
n.21	Waiting time setting for the Power Down Mode

To change the waiting time for the Power Down Mode,

1. Select **n.21** and press the jog dial. The default time “**300**” (300 minutes) is displayed on the control panel, as shown in the right figure.



2. Turn the jog dial to change the default time (The selection is available from **5 to 999** minutes).
3. Press the dial again and hold it until you hear a beep.
4. Restart the device to check if the new setting is saved correctly.

5.3.9 Buzzer On/Off

Follow the procedure below to turn on/off the buzzer. **Buzzer On** mode has three options: Battery Level 1 (flickering) warning only, Power Down Mode warning only, and both.

Service Mode No.	Item
n.22	Buzzer On/Off

To change the setting,

1. Select **n.22** and press the jog dial. The default setting “**002**” (Buzzer On for Power Down Mode warning only) is displayed on the control panel, as shown in the right figure.



2. Turn the jog dial to select an option out of the four options, as described below.

- “000” = Buzzer Off
- “001” = Buzzer On for Battery Level 1 (flickering) warning only
- “002” = Buzzer On for Power Down Mode warning only (**default**)
- “003” = Buzzer On for both

3. Press the dial again and hold it until a beep is heard.
4. Restart the device to check if the new setting is saved correctly (optional).

5.3.10 Power Down Mode On/Off

Follow the procedure below to turn on/off the Power Down Mode.

Service Mode No.	Item
n.23	Power Down Mode On/Off

To change the Power Down Mode On/Off setting,

1. Select **n.23** and press the job dial. The default setting “**001**” is displayed on the Control panel. (“**001**” = On, “**000**” = Off)



2. To turn off the Power Down Mode, turn the dial to change the setting from “**001**” to “**000**”.



3. Press the dial again and hold it until a beep is heard.
4. Restart the device to check if the new setting is saved correctly.
5. To turn on the Power Down Mode again, select **n.23** and repeat the procedure above.

5.3.11 Password Setting

Follow the procedure below to change the password.

Service Mode No.	Item
n.24	Password setting

To change the password,

1. Select **n.24** and press the jog dial. The default password “**000**” is displayed on the control panel, as shown in the right figure.



2. When the first digit flashes, turn the jog dial to change the password and then save it by pressing the jog dial.
3. Follow the same procedure for the next two digits.
4. Press the dial until you hear a beep.
5. Check if the new password has been correctly saved.

This page is intentionally left blank.

6. Troubleshooting

In instances of abnormal operation, error messages will be displayed on the Control panel. If a problem persists, please request assistance from the customer support information services.

Alarm/Error Messages

NOTICE

A.XX: A problem occurred, and the system performs the correction automatically. This alarm clears after the correction is completed.

E. XX: An error occurred. Turn the power off, and then turn it back on. If the error persists, contact your Service Representative.

Error Code	Check Parameter	Description
E.02	X-ray Generator	When error codes "E.02", "E.03", "E.04," and "E.05" appear, X-ray exposure is impossible even as the device's power remains steady. Restart the device to resolve those error codes. The device resumes to normal operations after a re-boot. (If the problem persists, please contact your Vatech representative.)
E.03		
E.04		
E.05		
A.06		Appears when the system needs cooling time due to continuous operation. This alarm clears when the system temperature goes down to normal.
A.07	System	Appears when the power is turned on while the user is pressing the Exposure Button or Remote Exposure Switch . Release the switch.
A.08	User	Appears when the exposure button is released before the due time. Hold the exposure button until the end of the selected exposure time.
A.09	Battery	Appears when the battery voltage is higher than the reference value. Check the battery.
A.10		Appears when the battery voltage is lower than the reference value during X-ray exposure. Charge the battery.
A.11		Appears when the user attempts imaging while the device is still connected to the charger. Always disconnect the device from the charger before the start.
E.12		Appears when the battery level is below the reference value during X-ray exposure.

Troubleshooting

Problem	Cause	Solution
The device is not turned on.	The power switch is not turned on properly.	Turn the device power switch off and turn it back on.
	Battery discharged	Recheck after charging the battery with a charger.
	Battery cable is not correctly connected.	Contact your Service Representative.
	Defective battery	Contact your Service Representative.
The control panel is not turned on.	Defective mainboard	Contact your Service Representative.
	Internal cable disconnected	Contact your Service Representative.
No X-ray emission	The generator is cooling.	Wait for the cooling time (refer to 'Duty Cycle').
	Defective Remote Exposure Switch	Contact your Service Representative.
	Internal cable disconnected	Contact your Service Representative.
	Defective generator	Contact your Service Representative.
	Tube lifecycle termination	Contact your Service Representative.
X-ray emission works, but exposure is too light or completely white.	The device has been positioned incorrectly.	Adjust the position of the device.
	Exposure time is too long.	Decrease the exposure time.
	The receptor is facing the wrong way.	Reposition the receptor.
X-ray emission works, but exposure is too dark.	Exposure time is too short.	Increase the exposure time.

This page is intentionally left blank.

This page is intentionally left blank.

7. Cleaning and Maintenance

7.1 Cleaning



WARNING

Before cleaning the device, make sure to turn off the device.

- The device surfaces can be cleaned with a soft cloth dampened in an alcohol-based, non-corrosive cleaning solution. If necessary, wipe off surfaces with disinfectant.
- If necessary, wipe off surfaces with disinfectant.
- Please observe the hygiene instructions of the phosphor plate scanner manufacturer.



CAUTION

When cleaning the surfaces, make sure that the device is not connected to the battery charger.



CAUTION

- DO NOT expose the device to any liquids.
- DO NOT use spray cleaner or disinfectant directly into the device as this could cause a fire.



NOTICE

The soft cloth should be damp but not dripping wet.



NOTICE

The cloths or wipes cannot be re-used.



7.2 Maintenance

VATECH requires periodic constancy tests to ensure image quality and the safety of the patient and operator.

Only **VATECH** authorized technicians can perform the inspection and service of this device. For technical assistance, contact the **VATECH** service center or your local **VATECH** representative.

Please observe the maintenance instructions of the phosphor plate scanner manufacturer.

Cautions and Notes

	DO NOT keep the device or its parts in a humid place or near a liquid substance.
	Avoid placing the device near chemical storage and gas-filled storage facilities.
	When the device is not in use for a long time, fully charge the battery and remove it from the device before storage.

7.2.1 Maintenance Task Checklist



Always turn off the device before performing any maintenance.

Tasks	Period
Before the operation, ensure that the device is clean and ready for use.	Daily
After using the device, make sure that the device has been turned off.	Daily
Wipe the device's outer covers with a dry cloth at the end of each day's operation.	Daily
 DO NOT use detergents or solvents to clean the outer covers of the device.	Daily
Ensure that the signal is audible and the X-ray emission light is visible when making an exposure.	Daily
Ensure that the yellow (exposure) indicator light turns on when the Exposure Button is pressed.	Daily
Ensure that the battery charging LED indicator comes on when charging the battery.	Daily
Ensure that the battery level indicator displays at least two levels (Battery Level 2). For more information on the battery levels, see '4.5 Using the Battery'.	Daily
Ensure that all visible labels are intact and legible.	Monthly



If any defects are found, do not operate the device since the problem must be handled only by qualified personnel.

This page is intentionally left blank.

8. Disposing of the Unit

This device is designed to be as safe as possible to use and dispose of to reduce environmental contamination. Many components of this device are environment-friendly and can be recycled.

All parts and components that contain hazardous materials must be disposed of by disposal regulations. (IEC 60601-1 Clause 7.9.2.15)

Part	Material	Recyclable	Waste Disposal Site	Hazardous waste; Needs Separate Collection
Covers	Plastics	•		
Boards		•		
Cables and transformer	Copper	•		
Packing	Polystyrene	•		
	Cardboard	•		
	Paper	•		
X-ray tube				•
Battery				•
Other parts			•	

IMPORTANT

Observe all regulations relevant to the disposal of waste in your country.



This symbol on the device and accompanying documents means that used electrical and electronic devices (WEEE) should not be mixed with general household waste.

For professional users in the European Union:

When discarding electrical and electronic devices (EEE), please contact your dealer or supplier for further information.

For disposal in countries outside of the European Union:

This symbol is only valid in the European Union (EU). When discarding this device, please contact your local authorities or dealer and ask for the correct disposal method.

This page is intentionally left blank.

9. Device Specifications

9.1 Mechanical Specifications

Dimensions

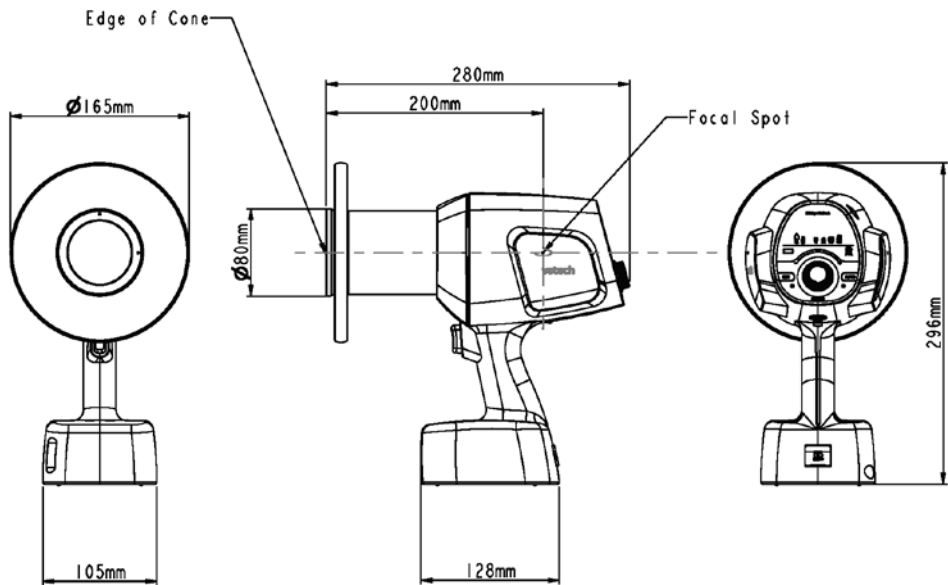

Item		Description	
Main Body	Dimension (mm)	280(L) x 296(H) x \varnothing 165	
	Weight (kg)	2.14 (\pm 10 %)	
X-ray Beam Limiting Device	X-ray Beam Area (mm)	Round Type	FOV: $< \varnothing$ 60
		Rectangular Type	FOV: 20 x 30, 40 x 30
	SSD(Source to Skin Distance) (mm)	200	

9.2 Technical Specifications

X-ray Generator

	Item	Description
High Voltage Generator (Assembly)	Model	DG- S0101V1
	Rated output power	Max. 0.2 kW
	Duty Cycle	1:60 or more (Exposure time: Interval time)
	Cooling Protection	Thermistor $\geq 65\text{ }^{\circ}\text{C}$
	Inherent Filtration	1.8 mm Al / 65 kV
	Total Filtration	Min. 1.5 mm Al
	Type	Inverter Type
	Tube Voltage	55-65 kV
	Tube Current	1.0-3.0 mA
X-ray Tube	Manufacturer	VATECH Co., Ltd.
	Model	V1-650304 (Stationary Anode type)
	Focal spot size	0.4 mm (IEC 60336)
	Anode heat contents	Max. 2.7 kJ
	Maximum Anode Heat Dissipation	200 W
	Target Material	Tungsten
	Target Angle	12.5°
	Inherent Filtration	Min. 1.5 mm Al
	X-ray Coverage	70 mm at SID 200 mm
	Tube Voltage	Max. 65 kV
	Tube Current	Max. 3.0 mA

X-ray Tube Characteristics

1) Maximum rating chart

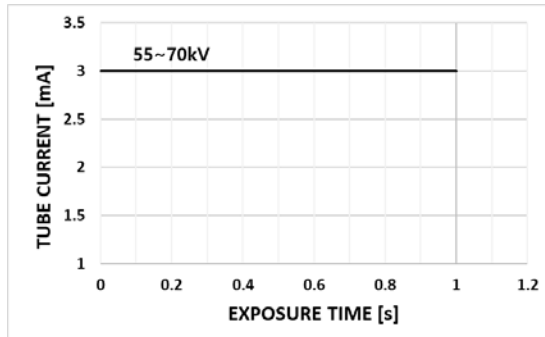

2) Emission characteristics

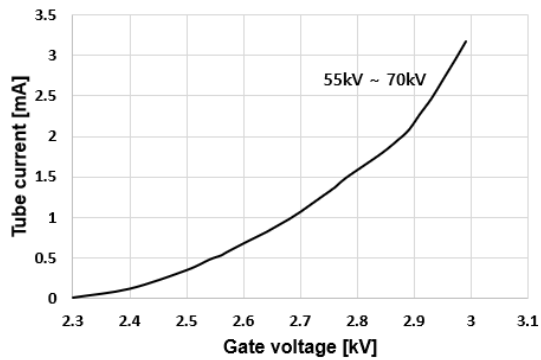

3) Heating and cooling curves of X-ray tube housing assembly

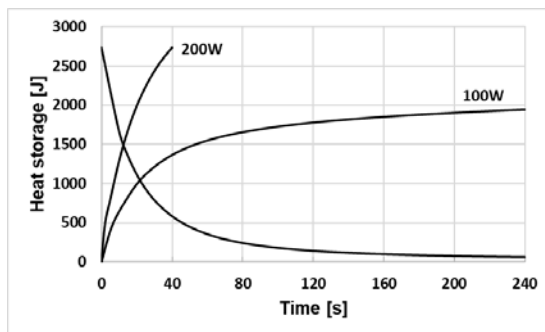

4) Tube Dimensions [mm]

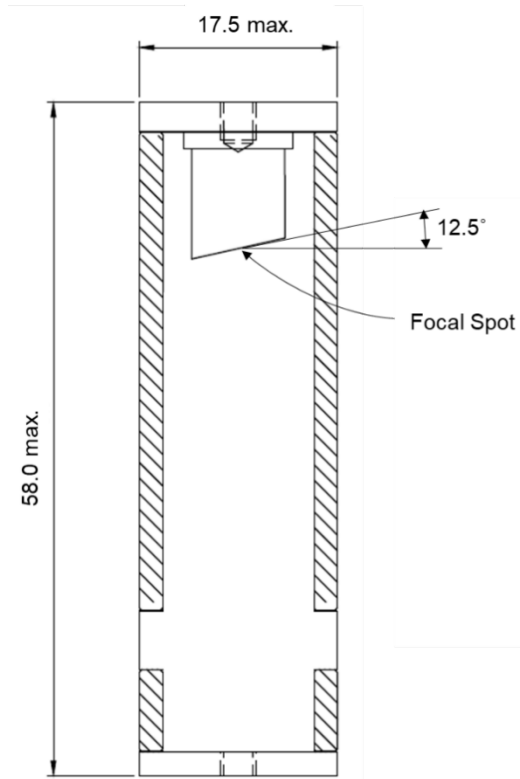

Battery

Item	Description	
Model	1MET-D801	VT0601-2500
Type	Lithium-Ion Rechargeable Battery	
Nominal Capacity	2500 mAh	
Nominal Voltage	21.6 V _{dc}	
Charging Voltage	25.2 V _{dc} (4.2 V _{dc} /Cell)	
Discharge Voltage	19.8 - 25.2 V _{dc}	

IMPORTANT

This equipment uses either 1MET-D801 battery or VT0601-2500 battery. The two battery specifications are identical.



Make sure to use the battery only provided or approved by **VATECH**. Using an unauthorized battery may result in severe injury and device damage. For details on using the battery, see 'Battery Use.'

Battery Charger

Item	Description
Model	XVE-2520200
Manufacturer	JIN XIN YU POWER(SHENZHEN)SUPPLY CO., LTD.
Rating	Input: 100-240 V~, 50/60 Hz, 1.5A Output: 25.2 V _{dc} , 2.0 A
Frequency	50/60 Hz
Standard	IEC 60950-1 (UL)
Power Cord	300 V, 2.5 A



Make sure to use the battery charger only provided or approved by **VATECH**. Using an unauthorized charger may result in severe injury and device damage. For details on using the battery charger, see 'Battery Use.'

NOTICE

- Power Supply is specified as a part of the ME EQUIPMENT.
- Power plugs may have various specifications for each country.

9.3 Electrical Specifications

Item	Description
Tube Voltage	Option 1: 60 kV fixed ($\pm 5\%$) Option 2: 65 kV fixed ($\pm 5\%$)
Tube Current	2.5 mA ($\pm 10\%$)
Exposure Time	0.05-1.0 s ($\pm 3\%$ or 10 ms)
Rated Voltage	21.6 V _{dc}

NOTICE

The system will be available with a fixed tube voltage specification based on the user selection.

NOTICE

Maximum exposures on a full charge: about 600 times at 65 kV, 2.5 mA, 0.2 s

9.4 Environmental Specifications

	Item	Description
During operating	Temperature	10 ~ 35 °C
	Relative humidity	30 ~ 75 %
	Atmospheric pressure	860 ~ 1060 hPa
Transport and storage	Temperature	-10 ~ 60 °C
	Relative humidity	10 ~ 75 % non-condensing
	Atmospheric pressure	860 ~ 1060 hPa

WARNING

Failure to follow the specifications above can result in severe injury and device damage.

10. Appendix

10.1 Combining the Holder and the devices using a tripod

NOTICE

Using a hand-held X-rays are not available in some countries. The operators in these countries must mount the device on a tripod using a holder (Read the instructions in this section)

The essential components for connecting the device to the tripod are packed/shipped in a separate box, as shown in the image below.



Remove all the box components and follow the procedure below to attach the base holder to the tripod.

NOTICE

To remove the holder, reverse the mounting procedure.

- Using a Phillips screwdriver, connect the EzRay Air Portable and Gender cable with the supplied screws.



- Attach the holder to a tripod. Refer to the Tripod manual for how to attach to a tripod.



3. Attach the EzRay Air Portable unit to the holder with the tripod, as shown in the image below.

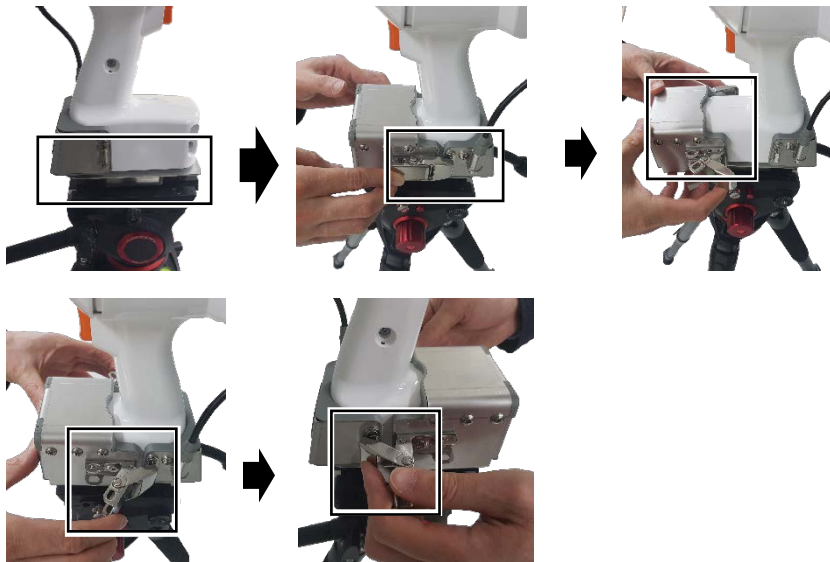

4. Connect one end of the Gender cable to the EzRay Air Portable device.



5. Connect the other end of the Gender cable connected to the holder to the supplied exposure cable.



10.2 Using the Rotating Rectangular Cover

Rotating Rectangular Cover rotates at 360 degrees.

Rotating Rectangular Cover consists of the Outer Ring and the Inner Ring.

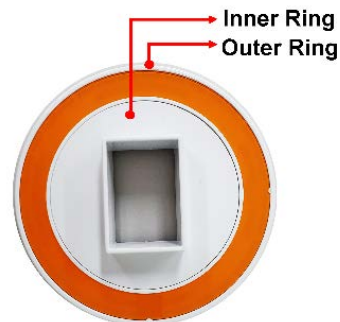

The Outer Ring rotates in 90-degree increments.

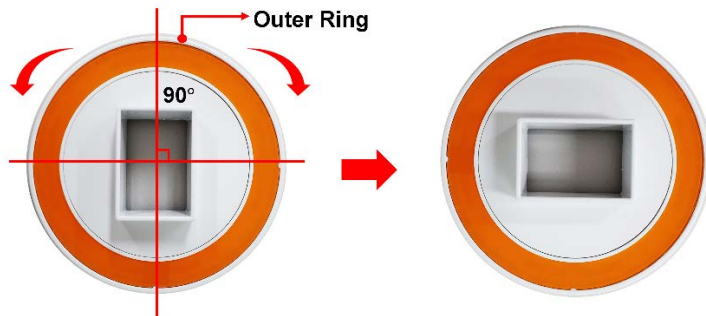

IMPORTANT

The Inner Ring rotates in 10-degree increments.

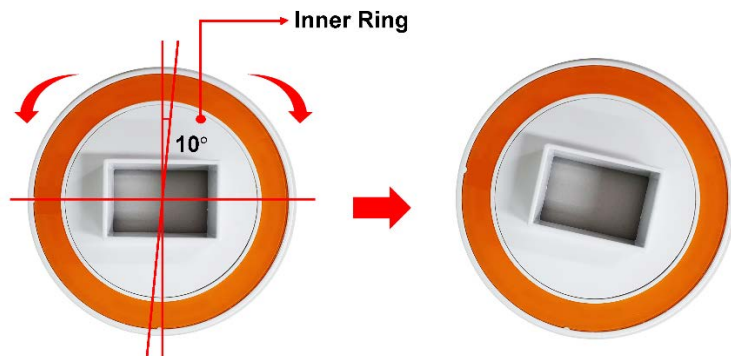

1. Assemble the Rotating Rectangular Cover to the Cone of the Main body.

NOTICE

For assembling the Rotating Rectangular Cover to the Cone, turn the Rotating Rectangular Cover 45 degrees and check the Click sound to ensure the assembly is complete.

2. Turn the Outer Ring of the Rotating Rectangular Cover to adjust the angle roughly.
3. Turn the Inner Ring of the Rotating Rectangular Cover to fine-tune the angle.

NOTICE











When disassembling the rotating cover, follow the assembly steps in reverse order.

10.3 Tables of Exposure Times (Default)











The following exposure timetables were established with a unit equipped with a cone that corresponds to a focus-to-skin distance of 200 mm (8 inches), respectively.

DIGITAL SENSOR

1) Option 1: 60 kV, 2.5 mA, 0.05~1.0 sec











Patient	Teeth	Angle of inclination	SSD: 200 mm (8 inches)		
			kV	mA	s
Adult 	Incisor 	Maxilla: +45° Mandible: -25°	60	2.5	0.14
	Canine 	Maxilla: +45° Mandible: -20°	60	2.5	0.16
	Molar/ Premolar 	Maxilla: +30° Mandible: -5°	60	2.5	0.18
	Bitewing 	+5° ~ +8°	60	2.5	0.20
Child 	Incisor 	Maxilla: +45° Mandible: -25°	60	2.5	0.12
	Canine 	Maxilla: +45° Mandible: -20°	60	2.5	0.14
	Molar/ Premolar 	Maxilla: +30° Mandible: -5°	60	2.5	0.16
	Bitewing 	+5° ~ +8°	60	2.5	0.18

2) Option 2: 65 kV, 2.5 mA, 0.05~1.0 sec











Patient	Teeth	Angle of inclination	SSD: 200 mm (8 inches)		
			kV	mA	s
Adult 	Incisor 	Maxilla: +45° Mandible: -25°	65	2.5	0.12
	Canine 	Maxilla: +45° Mandible: -20°	65	2.5	0.14
	Molar/ Premolar 	Maxilla: +30° Mandible: -5°	65	2.5	0.16
	Bitewing 	+5° ~ +8°	65	2.5	0.18
Child 	Incisor 	Maxilla: +45° Mandible: -25°	65	2.5	0.10
	Canine 	Maxilla: +45° Mandible: -20°	65	2.5	0.12
	Molar/ Premolar 	Maxilla: +30° Mandible: -5°	65	2.5	0.14
	Bitewing 	+5° ~ +8°	65	2.5	0.16

PSP Scanner (VistaScan Nano Easy)

1) Option 1: 60 kV, 2.5 mA, 0.05~1.0 sec

Patient	Teeth	Angle of inclination	SSD: 200 mm (8 inches)		
			kV	mA	s
Adult 	Incisor 	Maxilla: +45° Mandible: -25°	60	2.5	0.30
	Canine 	Maxilla: +45° Mandible: -20°	60	2.5	0.42
	Molar/ Premolar 	Maxilla: +30° Mandible: -5°	60	2.5	0.60
	Bitewing 	+5° ~ +8°	60	2.5	0.65
Child 	Incisor 	Maxilla: +45° Mandible: -25°	60	2.5	0.20
	Canine 	Maxilla: +45° Mandible: -20°	60	2.5	0.25
	Molar/ Premolar 	Maxilla: +30° Mandible: -5°	60	2.5	0.40
	Bitewing 	+5° ~ +8°	60	2.5	0.40

2) Option 2: 65 kV, 2.5 mA, 0.05~1.0 sec

Patient	Teeth	Angle of inclination	SSD: 200 mm (8 inches)		
			kV	mA	s
Adult 	Incisor 	Maxilla: +45° Mandible: -25°	65	2.5	0.28
	Canine 	Maxilla: +45° Mandible: -20°	65	2.5	0.40
	Molar/ Premolar 	Maxilla: +30° Mandible: -5°	65	2.5	0.58
	Bitewing 	+5° ~ +8°	65	2.5	0.63
Child 	Incisor 	Maxilla: +45° Mandible: -25°	65	2.5	0.18
	Canine 	Maxilla: +45° Mandible: -20°	65	2.5	0.23
	Molar/ Premolar 	Maxilla: +30° Mandible: -5°	65	2.5	0.38
	Bitewing 	+5° ~ +8°	65	2.5	0.38

10.4 X-ray Dose Data

The X-ray dose data is extracted from the X-ray Dose Test Report for the device. The IEC collateral standards measured the X-ray doses of the device in the test report. The device was designed by Part 1. General Requirements for Safety, IEC 60601-1-3.

Test Condition	
Model Name	VEX-P300
Tube Model Name	V1-650304
Generator Model Name	DG-S0101V1 (Inverter type)
Loading Factor	Option 1: 60 kV, 2.5 mA Option 2: 65 kV, 2.5 mA

10.4.1 X-ray Dose Table

Test Equipment			
Instrument	Manufacturer	Model	S/N
Multi-Dose Meter	Raysafe	Unfors Xi mAs / Unfors Xi R/F & MAM	163288 / 161834

Digital Sensor

Dose Area Product (DAP) Table (60 kVp, 2.5 mA, SSD 200 mm)			
	FOV: Ø 6 cm	FOV : 3 x 4 cm	FOV : 2 x 3 cm
t (s)	Dose (mGy.cm ²)		
0.14	6.5	2.8	1.4
0.16	7.5	3.2	1.6
0.18	8.5	3.6	1.8
0.20	9.8	4.2	2.1

Dose Area Product (DAP) Table (65 kVp, 2.5 mA, SSD 200 mm)			
	FOV: Ø 6 cm	FOV : 3 x 4 cm	FOV : 2 x 3 cm
t (s)	Dose (mGy.cm ²)		
0.12	6.7	2.9	1.4
0.14	7.9	3.4	1.7
0.16	9.1	3.9	1.9
0.18	10.2	4.3	2.2

Phosphor Plate

Dose Area Product (DAP) Table (60 kVp, 2.5 mA, SSD 200 mm)			
	FOV: Ø 6 cm	FOV : 3 x 4 cm	FOV : 2 x 3 cm
t (s)	Dose (mGy.cm ²)		
0.30	14.7	6.2	3.1
0.42	20.1	8.5	4.3
0.60	29.2	12.4	6.2
0.65	31.6	13.4	6.7

Dose Area Product (DAP) Table (65 kVp, 2.5 mA, SSD 200 mm)			
	FOV: Ø 6 cm	FOV : 3 x 4 cm	FOV : 2 x 3 cm
t (s)	Dose (mGy.cm ²)		
0.28	15.3	6.5	3.2
0.40	23.1	9.8	4.9
0.58	32.9	14.0	7.0
0.63	36.4	15.4	7.7

10.4.2 Leakage Dose

Scope

IEC 60601-2-65 203.12.4

Requirements

In the LOADING STATE, the AIR KERMA due to LEAKAGE RADIATION from X-RAY SOURCE ASSEMBLIES, 1 m from the FOCAL SPOT, average over an area of 100 cm² of which no principal linear dimension exceeds 20 cm when operated at the NOMINAL X-RAY TUBE VOLTAGE under the condition of LOADING corresponding to the reference LOADING conditions, shall not exceed 0.25 mGy in one hour.

Leakage Dose	Permissive Range
65 kVp, 2.5 mA, 1.0 s (Max. Exposure Condition) At Focal Spot to Distance 1 m 1 : 60 Duty Cycle	< 0.25 mGy/h

Test Equipment			
Instrument	Manufacturer	Model	S/N
X / Gamma Survey Meter	Radcal Co.	9015/10X5-180	91-1470/19069

Results

The following exposure timetables were established with a unit equipped with a cone that corresponds to a focus-to-skin distance of 200 mm (8 inches), respectively. When the leakage doses have been measured with each cover type (default, rectangular 2x3, and rectangular 4x3), all the results have been ND (Not Detected). The raw data about the results are shown in the table below.

The result (Horizontal Plane)

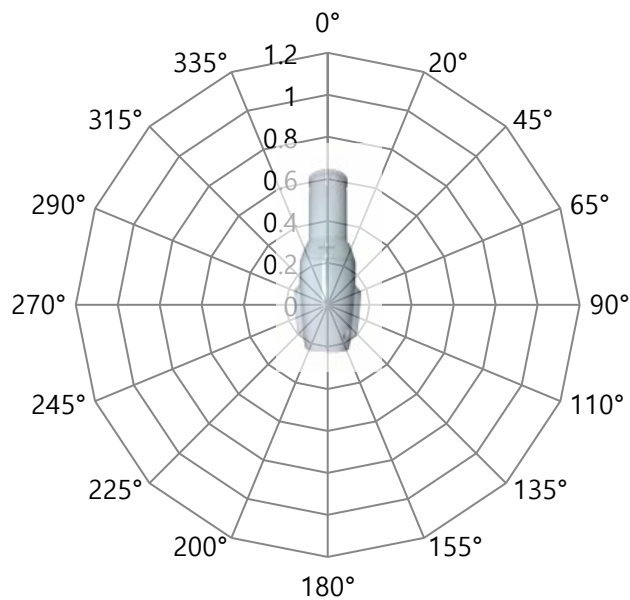

Direction	Default type [mGy/h]	Rectangular 2x3 [mGy/h]	Rectangular 4x3 [mGy/h]
0°	ND	ND	ND
20°	ND	ND	ND
45°	ND	ND	ND
65°	ND	ND	ND
90°	ND	ND	ND
110°	ND	ND	ND
135°	ND	ND	ND
155°	ND	ND	ND
180°	ND	ND	ND
200°	ND	ND	ND
225°	ND	ND	ND
245°	ND	ND	ND
270°	ND	ND	ND
290°	ND	ND	ND
315°	ND	ND	ND
335°	ND	ND	ND

The result (Vertical Plane)

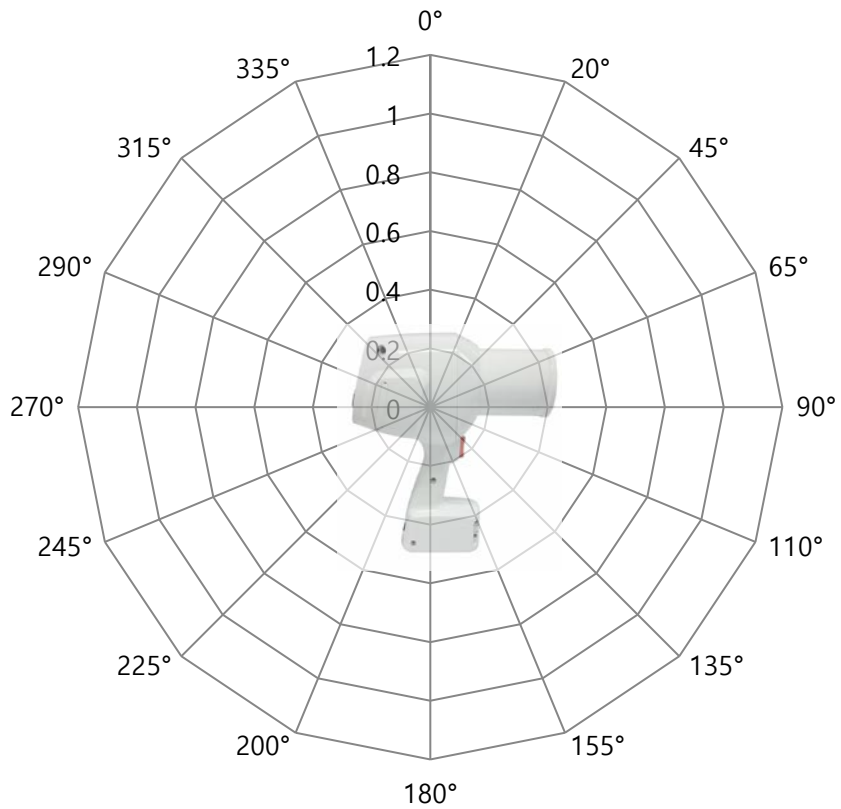

Direction	Default type [mGy/h]	Rectangular 2x3 [mGy/h]	Rectangular 4x3 [mGy/h]
0°	ND	ND	ND
20°	ND	ND	ND
45°	ND	ND	ND
65°	ND	ND	ND
90°	ND	ND	ND
110°	ND	ND	ND
135°	ND	ND	ND
155°	ND	ND	ND
180°	ND	ND	ND
200°	ND	ND	ND
225°	ND	ND	ND
245°	ND	ND	ND
270°	ND	ND	ND
290°	ND	ND	ND
315°	ND	ND	ND
335°	ND	ND	ND

- ND: Not Detected. The detection limit is 0.00001 mGy per exposure.

10.4.3 Scattered Dose

Scope

IEC 60601-2-65 203.13

Requirements

ME EQUIPMENT shall be provided with means to optionally allow actuation of the EXPOSURE from a PROTECTED AREA after installation.

Relevant instructions shall be given in the ACCOMPANYING DOCUMENTS.

Results

The following exposure timetables were established with a unit equipped with a cone that corresponds to a focus-to-skin distance of 200 mm (8 inches), respectively.

Test Equipment			
Instrument	Manufacturer	Model	S/N
X / Gamma Survey Meter	Radcal Co.	9015/10X5-180	91-1470/19069

Method
PMMA Phantom aligned to 280 mm away from Focal Spot
Max. Exposure Condition
Measure point: 1000 mm from PMMA Phantom

Option 1: 60 kV / 2.5 mA / 1.0 s

Direction [°]	Result (Horizontal Plane) [μR]	
	Without Shield	With Shield
0	63.4	68.14
20	17.8	11.99
45	18.5	13.01
65	19.8	14.76
90	27.1	20.65
110	41.6	32.08
135	63.4	46.18
155	68.1	11.14
180	3.29	2.893
200	51.5	7.557
225	47.5	48.63
245	33.7	33.27
270	23.4	33.25
290	19.8	18.06
315	17.2	15.23
335	19.2	14.71

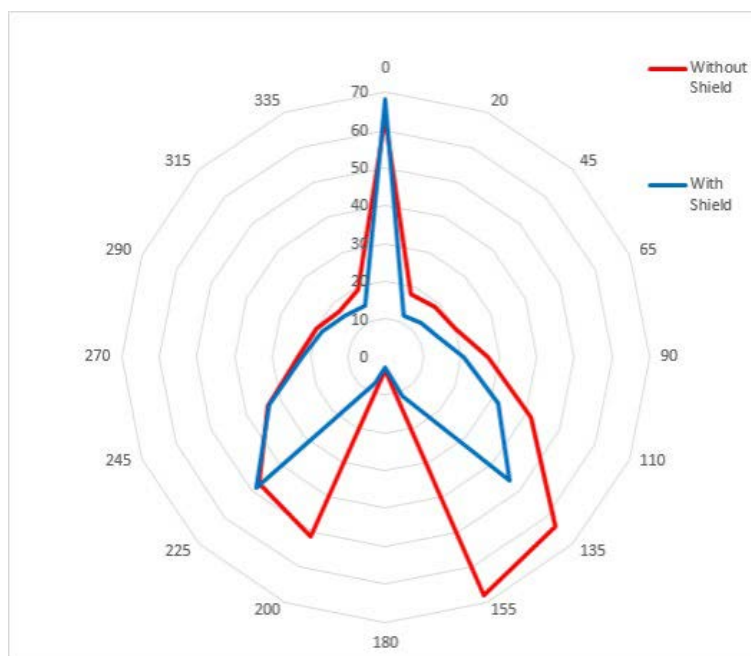

Direction [°]	Result (Vertical Plane) [μ R]	
	Without Shield	With Shield
0	25.8	29.8
20	27.3	26.8
45	18.5	22.5
65	15.9	18.5
90	74.1	72.1
110	15.9	18.5
135	17.2	13.5
155	19.9	17.9
180	19.2	17.9
200	27.8	31.4
225	13.9	10.6
245	38.4	8.6
270	7.9	4.3
290	48.4	11.9
315	60.2	52.3
335	41.7	45.7

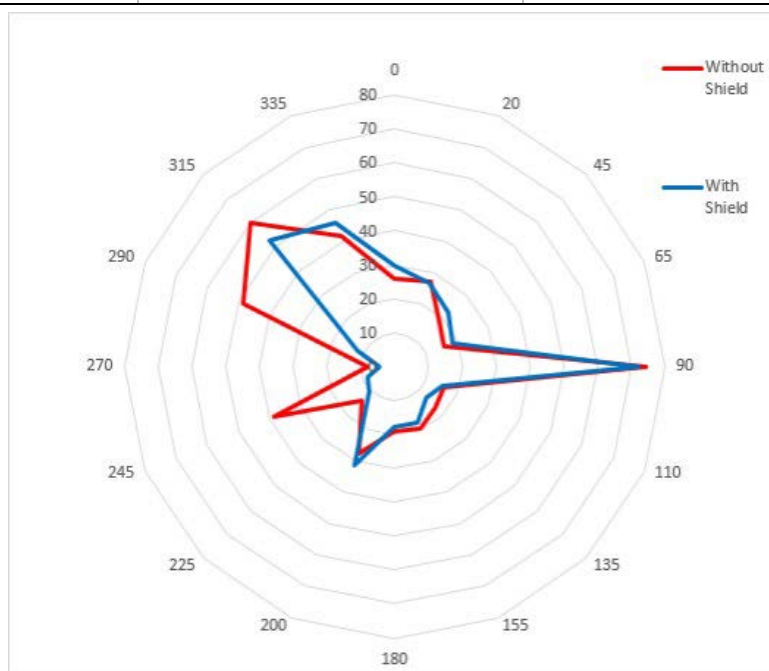

Option 2: 65 kV / 2.5 mA / 1.0 s

Direction [°]	Result (Horizontal Plane) [μR]	
	Without Shield	With Shield
0	58.8	85.2
20	22.5	30.4
45	39.6	42.7
65	47.6	40.3
90	46.9	42.9
110	47.6	66.7
135	92.5	48.9
155	87.9	34.3
180	11.9	11.9
200	94.5	28.4
225	89.2	80.3
245	86.2	49.5
270	51.6	42.3
290	47.6	43.6
315	27.1	30.7
335	40.4	23.1

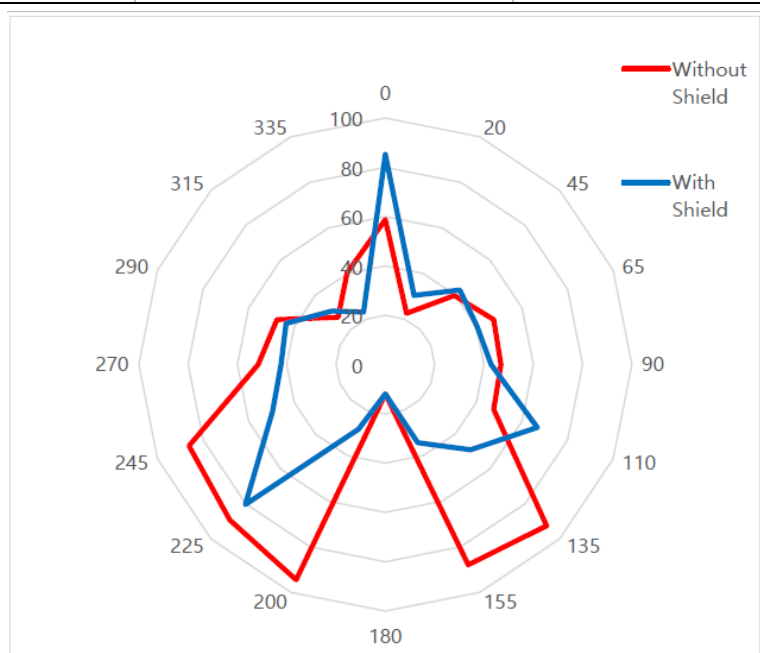

Direction [°]	Result (Vertical Plane) [μR]	
	Without Shield	With Shield
0	64.7	55.4
20	42.8	44.3
45	26.3	34.8
65	36.8	36.4
90	57.9	82.4
110	42.3	38.2
135	20.7	25.9
155	27.7	31.9
180	36.2	52.6
200	94.6	63.2
225	64.2	49.8
245	42.9	18.4
270	11.2	11.3
290	24.6	7.2
315	52.8	26.5
335	79.1	72.2

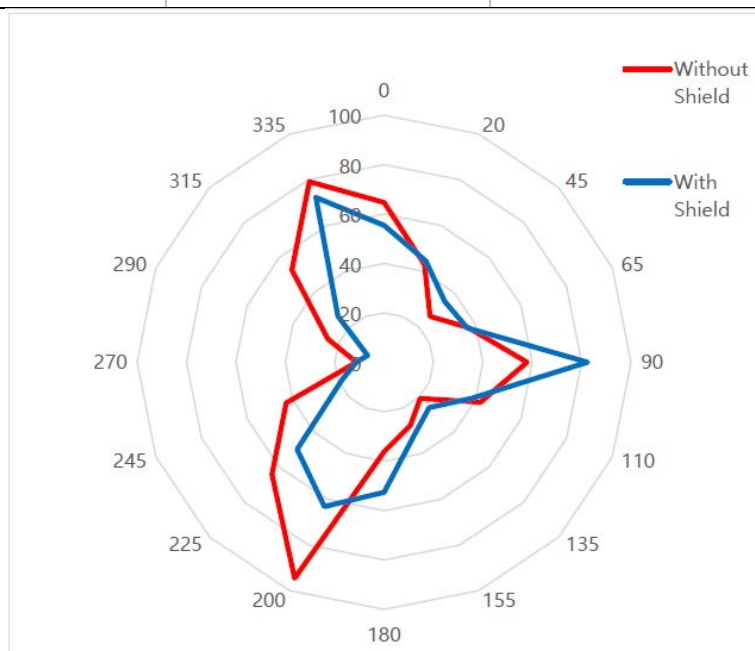

10.5 Electromagnetic Compatibility (EMC) Information

Guidance and manufacturer's declaration - electromagnetic emissions

The VEX-P300 is intended for use in the electromagnetic environment specified below. The customer or the user of the VEX-P300 should assure that it is used in such an environment.

Emissions test	Compliance	Electromagnetic environment - guidance
RF emissions CISPR 11	Group 1 Class A	The EMISSIONS characteristics of the VEX-P300 make it suitable for use in industrial areas and hospitals (CISPR 11 class A). If used in a residential environment (for which CISPR 11 class B is normally required), this equipment might not offer adequate protection to radiofrequency communication services. The user might need to take mitigation measures, such as relocating or re-orienting the equipment.
Harmonic emissions IEC 61000-3-2	Applicable	The VEX- P300 is suitable for use in all establishments and may be used in domestic establishments and those directly connected to the public low-voltage power supply network that supplies buildings used for domestic purposes.
Voltage fluctuations / flicker emissions IEC 61000-3-3	Applicable	

Guidance and manufacturer's declaration - electromagnetic immunity

The VEX-P300 is intended for use in the electromagnetic environment specified below. The customer or the user of the VEX-P300 should assure that it is used in such an environment.

Test of Electronic Interference Resistance	IEC 60601-1-2 test level	Compliance level	Electromagnetic environment – guidance
Electrostatic discharge (ESD) IEC 61000-4-2	Discharge by ± 8 kV direct contact ± 15 kV of Air-gap discharge	Discharge by ± 8 kV direct contact ± 15 kV of Air-gap discharge	Floors should be wood, concrete, or ceramic tile. If floors are covered with synthetic material, the relative humidity should be at least 30 %.
Radiated RF Electromagnetic Field IEC 61000-4-3	3 V/m 80 MHz-2.7 GHz 80% AM at 1 kHz	3 V/m 80 MHz-2.7 GHz 80% AM at 1 kHz	The VEX-P300 is suitable to use in a professional healthcare environment.
Immunity to Proximity Fields from RF wireless Communications Equipment according to Table 9 in IEC 60601-1-2	28 V/m Max. 385-5785 MHz in according to table 9	28 V/m Max. 385-5785 MHz in according to table 9	RF communication equipment is used on closer than 30 cm to any part of the VEX-P300, including cables specified by VATECH
Electrical fast transient/burst IEC 61000-4-4	± 2 kV for power supply lines ± 1 kV for input/output lines 100 kHz repetition frequency	± 2 kV for power supply lines ± 1 kV for input/output lines 100 kHz repetition frequency	The quality of supplied power should be suitable for the general business site or hospital environment.
Surge IEC 61000-4-5	± 1 kV line(s) to line(s) ± 2 kV line(s) to earth	± 1 kV line(s) to line(s) ± 2 kV line(s) to earth	The quality of supplied power should be suitable for the general business site or hospital environment.

Immunity to conducted disturbances induced IEC 61000-4-6	3 V 0.15-80 MHz 6 V in ISM bands between 0.15 and 80 MHz 80% AM at 1 kHz Power supply line & I/O lines	3 V 0.15-80 MHz 6 V in ISM bands between 0.15 and 80 MHz 80% AM at 1 kHz Power supply line & I/O lines	The strength of the RF field in the frequency range higher than 150 kHz ~ 80 MHz, the strength of the RF field is smaller than 3 V
The magnetic field of supply frequency (50/60 Hz) according to IEC 61000-4-8	30 A/m	30 A/m	The magnetic field of power frequency should coincide with the general level found in the business site or hospital environment
Voltage dips and short interruptions IEC 61000-4-11	0 % UT: 0.5 cycle At 0°, 45°, 90°, 135°, 180°, 225°, 270° and 315° 0 % UT; 1 cycle and 70 % UT; 25/30 Cycles Single phase: at 0° 0 % UT; 250/300 cycle	0 % UT: 0.5 cycle At 0°, 45°, 90°, 135°, 180°, 225°, 270° and 315° 0 % UT; 1 cycle and 70 % UT; 25/30 Cycles Single phase: at 0° 0 % UT; 250/300 cycle	The quality of supplied power should be suitable for the general business site or hospital environment. If the user of the VEX-P300 image intensifier requires continued operation during power mains interruptions, it is recommended that the VEX- P300 image intensifier is powered from an uninterruptible power supply.

10.6 Abbreviations

Acronym	Name
AL	Aluminum
EMC	Electromagnetic Compatibility
ESD	Electrostatic Discharge
FOV	Field of View
IEC	International Electrotechnical Commission
ISO	International Standards Organization
LED	Light-Emitting Diode
ME	Medical Electrical
PMMA	Poly Methyl Meth Acrylate
RF	Radio Frequency
SID	Source to Image receptor Distance
SIP	Signal Input Part
SOP	Signal Output Part
SSD	Source to Skin Distance

Copyright by © 2017 VATECH Co., Ltd.

All rights reserved.

The documentation, brand name, and logo used in this manual are copyrighted.

No part of this manual may be reproduced, transmitted, or transcribed without the manufacturer's written permission.

VATECH and **EzRay** have registered trademarks in the United States and other countries, and **EzRay Air Portable** is a trademark of **VATECH Co., Ltd.** worldwide.

Reserved the right to make any alterations that may be required due to technical improvement.
For the most current information, contact your **VATECH** representative.

Manufactured by VATECH Co., Ltd.

Tel: (+82) 1588 9510

Email: gcs@vatech.co.kr

Website: www.vatech.com

Head Quarters Address: 13, Samsung 1-ro 2-gil, Hwaseong-si, Gyeonggi-do, 18449, Korea

Factory Address: 13, Samsung 1-ro 2-gil, Hwaseong-si, Gyeonggi-do, 18449, Korea



The CE symbol grants this device compliance to the European Directive for Medical Devices 93/42/EEC as amended by 2007/47/EC as a class IIb device.



Authorized EU Representative: Vatech Global France (SARL)
51 Quai de Dion Bouton 92800 Puteaux France
Tel: +33 1 64 11 43 30
Fax: +33 1 64 11 43 39

Australia Sponsor; VATECH Medical Pty Ltd.
ABN: 78 155 258 923
Address: Suite 5.04 Gateway Business Park 63-79 Parramatta Road,
Silverwater, NSW 2128
Tel : 1300 789 454 (+61 2 9644 4866)
E-mail: info@vatechanz.com.au