



Postal Code: 445-170
13, Samsung 1-ro 2-gil, Hwaseong-si, Gyeonggi-do, Korea



PaX-i3D *Smart* (PHT-30LF0)

User Manual | Version 1.0.0

English

innovation **i**nside

"i" stands for 'innovation', one of the core values of VATECH, which aims to expand accessibility of medical solutions to more people.

Notice

Thank you for purchasing the **PaX-i3D Smart** extra-oral imaging system.

The **PaX-i3D Smart** is an advanced digital dental diagnostic system that incorporates PANO, CEPH, and CBCT imaging capabilities into a single system.

This manual describes how to operate the **PaX-i3D Smart** system. It is recommended that you thoroughly familiarize yourself with this manual in order to make the most effective use of this equipment.

Observe all cautions, safety messages and warnings which appear in this manual.

Due to a constant technological improvement, the manual may not contain the most updated information, subjecting to change without prior notice to the persons concerned. For further information not covered in this manual, please contact us at:

VATECH Co., Ltd.

Phone: +82-1588-9510

E-mail: gcs@vatech.co.kr

This document is originally written in English.

The PaX-i3D Smart is referred to as Equipment in this manual.

Manual Name: PaX-i3D Smart (Model: PHT- 30LFO) User Manual

Version: 1.0.0

Publication Date: 2014-10

Table of Contents

1. General Information	2
1.1 Manufacturer's Liability	2
1.2 Owner and Operator's Obligations	2
1.3 Conventions in this Manual	3
1.4 Marks and Symbols	4
2. Warnings and Precautions	6
2.1 General Safety Precautions	6
2.2 Electricity-related Safety Precautions	9
2.3 Radiation Safety	11
2.4 Warnings	12
3. Imaging System Overview	16
3.1 Introduction	16
3.2 Imaging System Configuration	19
3.3 Equipment Overview	21
4. Imaging Software Overview	30
4.1 PC Specifications	30
4.2 EasyDent / EzDent-i	32
4.3 Console Software	33
5. Getting Started	38
5.1 Turning On Equipment	38
5.2 Running the Image Viewer	40
5.3 Initiating the Console Software	44
6. Acquiring PANO images	48
6.1 Setting Exposure Parameters	53
6.2 Patient Positioning	57
6.3 X-ray Exposure	71
6.4 Finishing Scan	72
6.5 Confirming Image	72

Table of Contents

7. Acquiring CEPH images	74
7.1 Setting Exposure Parameters	76
7.2 Patient Positioning.....	79
7.3 X-ray Exposure.....	89
7.4 Finishing Scan.....	90
7.5 Confirming Image	90
8. Acquiring CT Images	92
8.1 Setting Exposure Parameters	92
8.2 Patient Positioning.....	94
8.3 X-ray Exposure.....	100
8.4 Finishing Scan.....	101
8.5 Confirming Image	101
9. Troubleshooting	104
10. Cleaning and Maintenance.....	108
10.1 Cleaning.....	108
10.2 Maintenance	109
11. Disposing of the Unit.....	112
12. Technical Specifications	114
12.1 Mechanical Specifications	114
12.2 Technical Specifications	119
12.3 Electrical Specifications	123
12.4 Environmental Specifications	123
13. Appendices	126
13.1 Recommended X-ray Exposure Table	126
13.2 X-ray Dose Data	128
13.3 Electromagnetic Compatibility (EMC) Information	132
13.4 Abbreviations	135

1

General Information

- 1.1 Manufacturer's Liability2
- 1.2 Owner and Operator's Obligations....2
- 1.3 Conventions in this Manual.....3
- 1.4 Marks and Symbols4

1. General Information

1.1 Manufacturer's Liability

The manufacturers and/or retailers of this equipment assume responsibility for the safe and normal operation of this product only when:

- The equipment has been installed by a VATECH authorized technician.
- The equipment has been installed in accordance with all of the cautions and conditions for installation.
- Genuine VATECH approved equipment and components have been used at all times.
- All maintenance and repairs have been performed by a VATECH authorized agent.
- The equipment has been used normally in accordance with the user's manual.
- The equipment damage or malfunction is not the result of an error on the part of the owner or operator.

1.2 Owner and Operator's Obligations







- The owner of this equipment shall perform constancy tests at regular intervals in order to ensure patient and operator safety. These tests must be performed in accordance with local X-ray safety regulations.
- The owner of this equipment shall perform regular inspection and maintenance of the mechanical and electrical components in this equipment to ensure safe and consistent operation (IEC 60601-1). The owner of this equipment shall ensure inspection and cleaning works are performed in accordance with the maintenance schedule outlined in **Chapter 8 Cleaning and Maintenance**.

1. General Information

1.3 Conventions in this Manual

















The following symbols are used throughout this manual. Make sure that you fully understand each symbol and follow the instructions which accompany it.

To prevent personal injury and/or damage to the equipment, please observe all warnings and safety information included in this document.

	WARNING	Indicates information that should be followed with the utmost care. Failure to comply with a warning may result in severe damage to the equipment or physical injury to the operator and/or patient.
	CAUTION	Indicates a situation that demands prompt and careful action, a specific remedy, or emergency attention.
	X-ray	Indicates a possible danger of exposure to radiation.
	IMPORTANT	Indicates a situation or action that could potentially cause problems to the equipment and/or its operation.
	NOTE	Emphasizes important information or provide useful tips and hints.
	SINGLE USE	Indicates a component which must be replaced for each new patient.

1. General Information

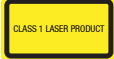
1.4 Marks and Symbols

Symbols	Description	Location
	Alternate current	-
	Attention: consult accompanying documents	Label
	Dangerous voltage	Power board
	Protective earth (Ground)	Power board
	Off (power: disconnect from the main switch)	Main switch
	On (power: connect to the main switch)	Main switch
	IEC60601-1 Degree of Protection from Electric Shock TYPE B Equipment	Label
	Radiation hazard	Label
	EC representative	Label
	The CE symbol indicates that this product complies with the European Directive for Medical Devices 93/42/EEC as amended by 2007/47/EC as a class IIb device.	Label
	UL mark: UL 60601-1 / CAN/CSA C22.2 No.601.1 3ZY1	Label
	Address where the equipment was manufactured	Label
	This symbol indicates that electrical and electronic equipment must not be disposed of as unsorted municipal waste and must be collected separately	Label
	This symbol warns ESD hazard.	MCU board/Board package
	This symbol indicates that this equipment is classified as a CLASS 1 LASER PRODUCT in accordance with IEC 60825-1 ED.1 regulations.	Label
	Date of manufacture	Label
	Refer to Instruction manual	Label

2 | Warnings and Precautions

2.1	General Safety Precautions.....	6
2.2	Electricity-related Safety Precautions	9
2.3	Radiation Safety.....	11
2.4	Warnings	12

2. Warnings and Precautions



Be sure to strictly observe all warnings and safety instructions included in this manual.

2.1 General Safety Precautions

Operator qualifications

This equipment may only be operated by personnel fully trained in its operation.

- To operate this equipment, all operators must:
 - have read and understood the user's manual
 - be familiar with the fundamental structure and functions of this equipment
 - be able to recognize irregularities in the operation of this equipment and implement appropriate measures to remedy such irregularities.

General safety precautions

- Follow the instructions specified in this manual to ensure the safety of both the patient and the operator.
- The operator must maintain visual contact with the patient at all times during imaging.
- Do not open or remove the cover panels on this equipment. Always have a trained and authorized service technician carry out inspection and maintenance of this equipment.
- Do not place foreign objects on this equipment at any time.
- Do not place any objects within this equipment's field of operation.
- Do not push or pull the equipment. If equipment overbalances, resulting in the risk of physical injuries or property damage.
- Operators must ask the patient to remain still until the equipment arm has stopped moving and the reset motion is complete.

2. Warnings and Precautions

- Observe all local fire regulations. Always keep a fire extinguisher near the equipment.
- The operator of this equipment must be familiar with this equipment's emergency protocols.
- Ensure that this equipment is kept away from water, moisture, or foreign substances at all times.
- If this product is exposed to water, moisture, or a foreign substance, immediately turn off all power to the equipment and contact your VATECH technical support representative.
- Immediately cease all operation of this equipment if there are signs of oil leakage and contact you VATECH technical support representative.

Ventilation

- Do not obstruct the equipment's ventilation for air opening. Improper ventilation could result in the equipment overheating due to a lack of air circulation.
- Do not spray any type of liquid or aerosol on this equipment as this may penetrate the system and damage the electrical and mechanical components inside.
- Always leave a sufficient amount of space around the PC to allow for proper ventilation.

Hygiene



Always disconnect the equipment from the power outlet when disinfecting the surfaces of the equipment.

- All removable patient support components (bite block, chin support, temple supports) can be cleaned using alcohol-based cleaning solutions.
- Patient support handles can be cleaned using alcohol-based cleaning solutions.
- Other surfaces of the equipment can be cleaned using a soft cloth dampened with a mild cleaning solution.
- Disinfect the components (bite block, temple supports etc.) of the equipment that come into contact with the patient or the operator after each exposure.

2. Warnings and Precautions

- New hygiene cover must be provided for each new patient to prevent the transmission of communicable disease.



Do not use aerosol or spray cleaning agents directly on the surface of the equipment.

Condensation

- Extreme fluctuations in temperature may cause condensation to develop inside the equipment. Do not turn on the equipment until it has reached room temperature.

Cooling

- Allow the proper amount of cool down time (for the X-ray tube to cool down) to elapse between each image acquisition.
 - Mode of operation: Continuous operation with intermittent loading.
 - Exposure time: Max. 18 s / Resting time: 5 min.
 - Column operation time: 1 min / Resting time: 9 min
- If the temperature inside the tube head reaches 60 °C, X-ray exposure will cease and an error message will be displayed. Normal X-ray capabilities will resume after the generator reaches 58 °C (136.4 °F).
- If the fan (optional) is installed, it operates automatically when the temperature surrounding the tube head reaches the pre-defined level: 40 °C (104 °F). The set point temperature is configurable.

Turning the equipment on / adjusting the height of the equipment

- Do not position the patient in the equipment while it is initiating as the patient could be injured if the equipment malfunctions.
- Ensure that the patient is kept clear of the mechanism while adjusting the height of the equipment.

2. Warnings and Precautions

Emergency stop

- If a problem occurs during image acquisition, press the red emergency stop button to immediately stop all moving parts and cut off all power to the equipment.

Trouble-free operation

- Never use this equipment in an environment that is susceptible to explosion.
- Always operate the equipment within a temperature range of 10 °C to 35 °C (50 °F to 95 °F) for the safe operation. Image quality may deteriorate if the equipment is operated outside of this range.
- Always allow the equipment sufficient time to warm up (while switched on) if it has been exposed to temperatures of below 10 °C (50 °F).
- Only perform X-rays of patients if system is in full working order.
- Always ensure that equipment movement is not obstructed by the patient's clothing, medical device (such as a wheelchair), or the patient themselves.
- Do not leave the patient unattended around the equipment.
- Remove all radio-controlled devices, mobile phones, etc. from the X-ray room prior to image acquisition as these objects may cause the equipment to malfunction.

Modifying the equipment

- Modifying the equipment in any way which may affect the safety of the operator, patient or other persons is prohibited by law.
- No part of this equipment is serviceable by the user. All maintenance and repair of this equipment must be performed by a qualified service technician.
- This product may only be operated with original VATECH accessories or third-party accessories expressly approved by VATECH.

2.2 Electricity-related Safety Precautions

- Check the status of the power source, PC and cables prior to operating the equipment.
- Ensure that the on/off switch is set to off when the equipment is not in use.
- Always disconnect the power supply before cleaning the equipment.
- Always keep electrical cords away from hot appliances or radiators.

2. Warnings and Precautions

- DO NOT place the PC or peripheral equipment connected to the PC in the immediate vicinity of the patient.
- The equipment and PC should be connected to a common protective earth.
- Never overload the equipment's circuit by sharing it with too many appliances.
- Use the same power circuit for the PC and the equipment.

Combining this equipment with other devices

- Do not connect this equipment to devices which are not part of the system.
- Do not connect this equipment to a Multiple Portable Socket-Outlet (MPSO) or extension cord.

Electromagnetic compatibility

- This equipment complies with IEC standard 60601-1-2.

Medical electrical equipment is subject to special EMC preventive measures. It must be installed and operated as specified in the **Installation Requirements** document.

If high-voltage systems, radio link systems or MRI systems are located within 5 m of the unit, please observe the specifications stated in the installation requirements.

Portable and mobile RF communications equipment may interfere with medical electrical equipment. Therefore, the use of mobile wireless phones in medical offices or hospital environments must be prohibited.

For more details, refer to the document **Electromagnetic Compatibility Information**.

Please also observe the **ESD (ESD: Electro-Static Discharge)** protective measures described below.

Static Discharge

- Connector pins or sockets bearing ESD warning labels must not be touched or interconnected without observing ESD protective measures.



Electrostatic discharge (ESD)

2. Warnings and Precautions

ESD protective measures include

- Procedures for preventing electrostatic charge build-up (e.g. air conditioning, air moistening, conductive floor coverings and non-synthetic clothing)
- Discharge the electrostatic charges of your own body on the frame of the UNIT, the protective ground wire or large metallic objects.
- Use the wrist band for grounding.

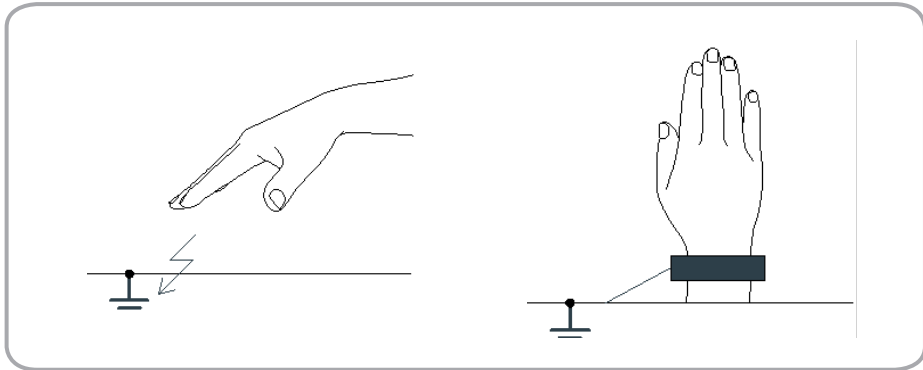

2.3 Radiation Safety



Since rules and regulations concerning radiation safety differ between countries, it is the responsibility of the owner and/or operator of this equipment to comply with all applicable rules and regulations concerning radiation safety and protection in their area.

- The operator must remain outside a shielded room during X-ray exposure in order to protect himself/herself from radiation.
- The patient must wear a lead apron with neck and thyroid protection during X-ray exposure.
- Children and pregnant women must consult with a doctor before X-ray exposure.
- This equipment must be housed inside an X-ray shielded room.
- During imaging; the operator must maintain visual contact with the patient from outside the shielded area.
- The operator should continuously check the status of the patient and the equipment during imaging.

2. Warnings and Precautions

- The operator must immediately stop imaging if the equipment malfunctions.
- The operator should be at least 2 m (6 feet) away from the equipment during imaging.



As a manufacturer of radiology equipment that conforms to stringent protection standards around the world, we guarantee the maximum degree of protection against radiation hazards for our equipment.

2.4 Warnings

The following warning statements should be obeyed with the utmost care. Failure to follow these warnings may cause severe damage to the equipment or physical injuries to the patient and/or operator.



X-ray equipment is hazardous to patient and the operator if proper exposure safety measures and/or operating instructions are not observed.

It is important to read this user manual carefully and strictly abide by all warnings and cautions stated within it.



- 3D image should not be used for screening examinations. Each exam must be justified by demonstrating that the benefits outweigh the risk.
 - Where it is likely that evaluation of soft tissues will be required as part of the patient's radiological assessment, conventional medical CT or MR should be used instead of dental cone beam imaging.
-



Federal law restricts this device to sale by or on the order of dentist or with the descriptive designation of any other practitioner licensed by the law of the State in which he practices to use or order the use of the device.

2. Warnings and Precautions

Lasers

- The system incorporates Class 1 laser products. The light localizers used in this product are intended for correct patient positioning and must not be used for any other purpose.
- For maximum safety, advise the patient not to look directly at the laser beam.
- While adjusting the patient, ensure that the laser beam is not directed at the patient's eyes.



Risk of eye injury!

Do not use this equipment with any other laser sources and do not make any changes to the settings or processes that are described in these operating instructions.

Cleaning

- Never expose this equipment to liquids, mists or sprays. Exposing this equipment to liquids may cause an electrical shock or otherwise damage the system.
- Do not use spray cleaners on this equipment, as this could cause a fire.

During Operation

- Never use this equipment in an environment that is susceptible to explosion.
- Do not place flammable materials near this equipment.
- Do not operate the PC while the equipment is performing an operation. Failure to comply with this instruction may result in system malfunction.
- Immediately stop imaging if the equipment malfunctions in any way.
- If a problem occurs during imaging, press the red emergency stop button to immediately stop all moving parts and cut off all power to the equipment's electrical components.
- Never touch the patient while also touching the SIP/SOP connectors.
- The medical electrical equipment or medical electrical system should not be used adjacent to or stacked with other equipment and that if adjacent or stacked use is necessary, the medical electrical equipment or medical electrical system should be observed to verify normal operation in the configuration in which it will be used.

2. Warnings and Precautions

- The use of accessories, transducers and cables other than those specified, with the exception of transducers and cables sold by the VATECH of the medical electrical equipment or medical electrical system as replacement parts for internal components, may result in increased EMISSIONS or decreased IMMUNITY of EQUIPMENT or SYSTEM.

In case of electrical fire

- Use only fire extinguishers designed for electrical fires to extinguish fires on this equipment.

Liquid extinguishers, such as those which use water, could damage the equipment and/or cause injury.

- Unplug the equipment's power cable before extinguishing any fire.

Installation

- In order to avoid improperly balanced equipment, install the device on a flat surface to maintain stability.
- If the equipment is not stable, property damage and/or personal injury may occur.
- Do not push or pull the equipment.
- Equipment should only be installed by an authorized technician, complying with proper installation procedures.

3 | **Imaging System Overview**

3.1	Introduction	16
3.2	Imaging System Configuration	19
3.3	Equipment Overview	21

3. Imaging System Overview

3.1 Introduction

PaX-i3D Smart is an advanced digital dental diagnostic system that incorporates Panoramic (PANO), Cephalometric (CEPH), and CBCT imaging capabilities into a single system.

3.1.1 Intended Use

The **PaX-i3D Smart** system is intended for use to take a panoramic, cephalometric and CT image of the oral and craniofacial anatomy to provide diagnostic information for adult and pediatric patients. The **PaX-i3D Smart** system uses the advanced sensors to produce the higher quality of image in 2D and 3D of the head region, including the dental/maxillofacial regions.

The **PaX-i3D Smart** may only be used by dentists, X-ray technicians and other professionals who are licensed to perform X-rays by the law of the region in which it is being used.

3.1.2 System Components

- PaX-i3D Smart digital x-ray equipment
- PC system
- Imaging Software
- EasyDent / EzDent-i: 2D viewer and patient management software
- Ez3D plus / Ez3D-i: 3D viewer and image analysis software

3.1.3 Features

- Low dose Imaging
- 3D Pan and Real 2D image acquisition by single scan
- 3D Viewer (Ez3D-i): 3D imaging supports precision analysis and diagnosis
- Supports the international digital imaging standard DICOM

3. Imaging System Overview

3.1.3 PaX-i3D Smart Options

Model	Item	Sensor	
SP	PANO+CBCT	PANO/CT	Xmaru1404CF
SC	PANO+CBCT +CEPH	PANO/CT	Xmaru1404CF
		CEPH	Xmaru2301CF
OS	PANO+CBCT +CEPH	PANO/CT	Xmaru1404CF
		CEPH	910SGA
OP	PANO+CBCT +CEPH	PANO/CT	Xmaru1404CF
		CEPH	1210SGA

3.1.5 Standards and Regulations

Standards

PaX-i3D Smart was designed and developed to comply with the following international standards and regulations.

IEC/EN/UL 60601-1, IEC/EN 60601-1-1, IEC/EN 60601-1-2, IEC/EN 60601-1-3,

IEC/EN 60601-2-7, IEC/EN 60601-2-28, IEC/EN 60601-2-32, IEC/EN 60601-2-44

ISO 9001, ISO 13485

21 CFR 1020.30, 31, 33

NEMA Standard publication PS 3.1-3.18, 2008

X-Ray source assembly [DG-07C11T2] IEC 60601-2-28 (1993)



This is Class11b equipment and received the CE mark for regulations compliance in accordance with the revised Medical Devices Directive 93/42 EEC.



This equipment received the UL certification mark in accordance with UL 60601-1/CAN/CSA C22.2 No.601.1 regulations.

3. Imaging System Overview

■ Classification (IEC60601-1 6.1)

- Degree of protection against the ingress of water: Ordinary Equipment: IPX0
- Degree of protection against electric shock: Class 1 equipment, Type B Applied Parts



3. Imaging System Overview

3.2 Imaging System Configuration

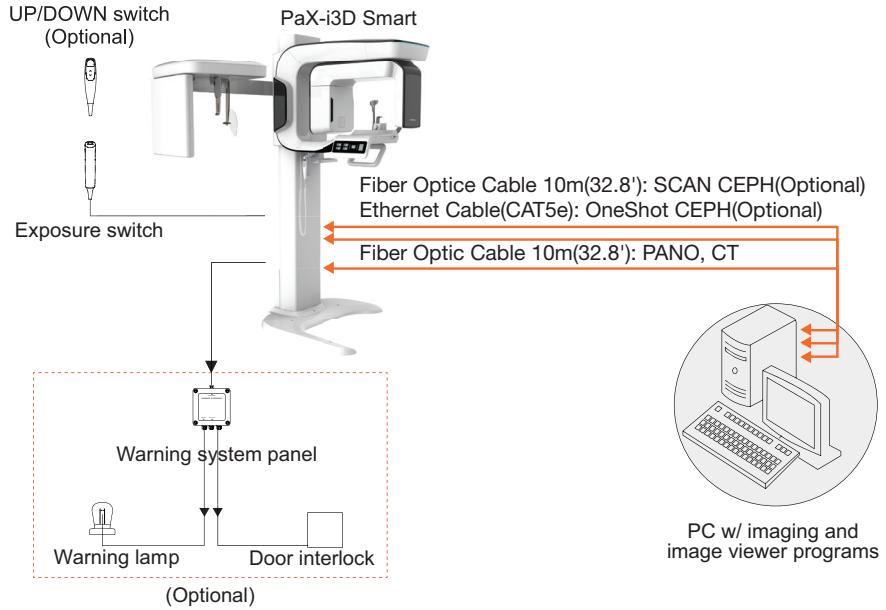

3. Imaging System Overview

■ PC Signal Input / Output

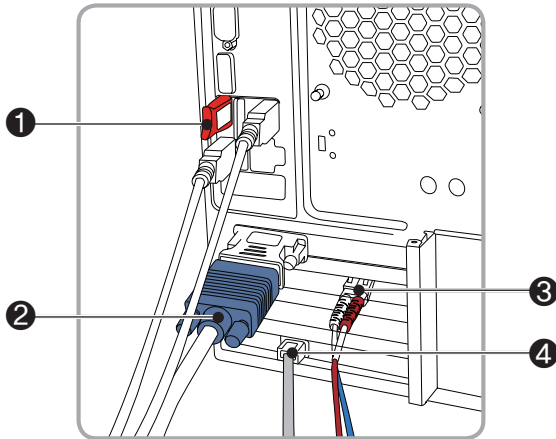

No.	Parts
1	3D Viewer License Key
2	Video out
3	Fiber optic cable in / out x 2 (PANO/CT, CEPH)
4	Ethernet cable(CAT5e) for OneShot CEPH(optional)

3. Imaging System Overview

3.3 Equipment Overview

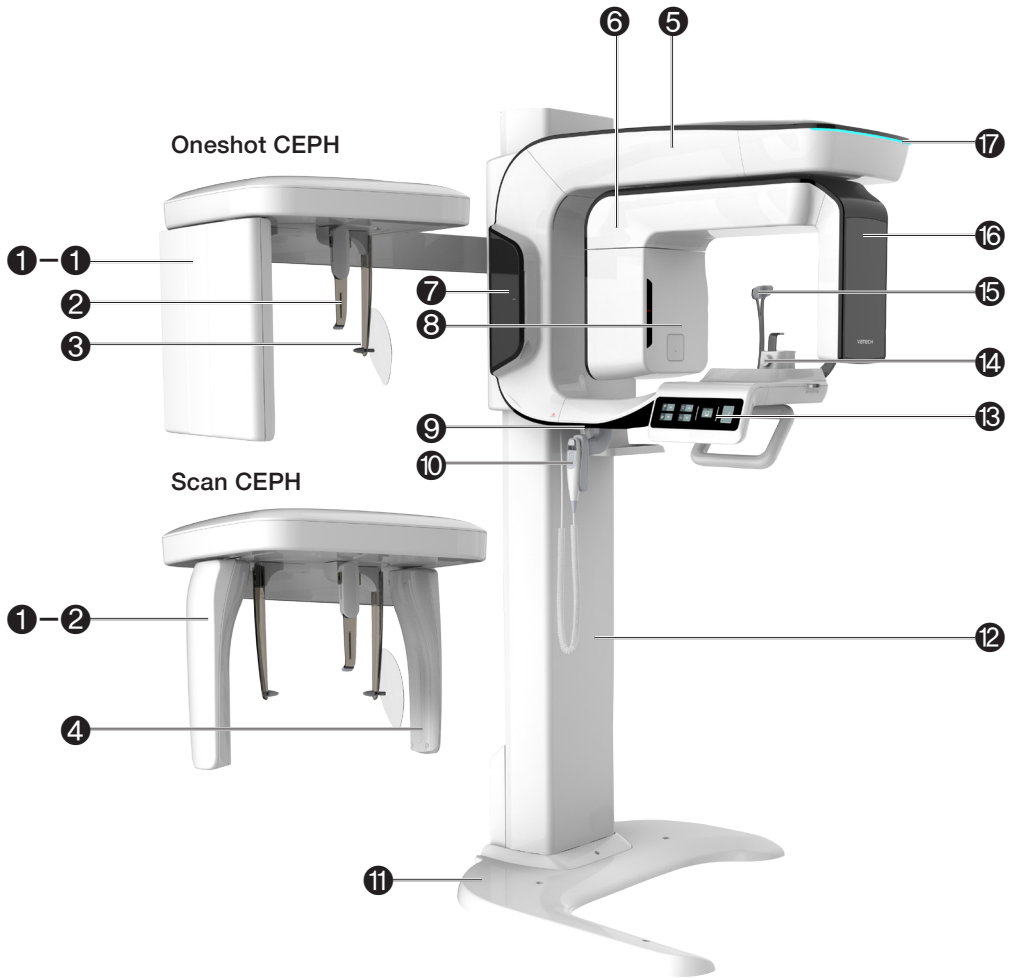

3. Imaging System Overview

No.	Name	Function
1	X-ray Sensor (CEPH)	CEPH imaging sensor (optional) - 1-1. One shot Type - 1-2. Scan Type
2	Nasal Positioner	- Positions the patient during CEPH imaging. - The ruler for use to compensate the acquired image that is different from actual size.
3	Ear Rod	Secure the patient's head during CEPH imaging.
4	Secondary Collimator	Limits the X-ray irradiation field for CEPH scanning.
5	Vertical Frame	Holds the Rotating Unit. Use the Vertical Frame Up/Down switch.
6	Rotating Unit	Rotates around the patient's head as image is being acquired. Movement depends on the scan mode.
7	Accessory Storage	Place where bite blocks, integrated chin rests and the other accessories are stored.
8	X-ray Tube	The vacuum tube where the x-ray is produced.
9	Emergency Switch	Powers off the equipment when there is a problem during operation.
10	Vertical Frame Up/Down Switch (optional)	Adjusts the height of the vertical frame.
11	Base (optional)	Balances the equipment and maintains its safety.
12	Stationary Column	A fixed column.
13	Control Panel	Operates the horizontal beam, opens/closes temple supports, and adjusts the height of the vertical frame and prepares for operation when the Ready button is pressed.
14	Chin Rest	A place to rest the chin.

3. Imaging System Overview

No.	Name	Function
15	Temple Supports	Patient head support: Use in PANO and CBCT modes.
16	X-ray Sensor (PANO/CT)	PANO / CBCT Sensor
17	LED Lamp	Indicates the emission status while the x-ray is in operation. - Green: Ready - Orange: X-ray ON

3. Imaging System Overview

3.3.1 Control Panel

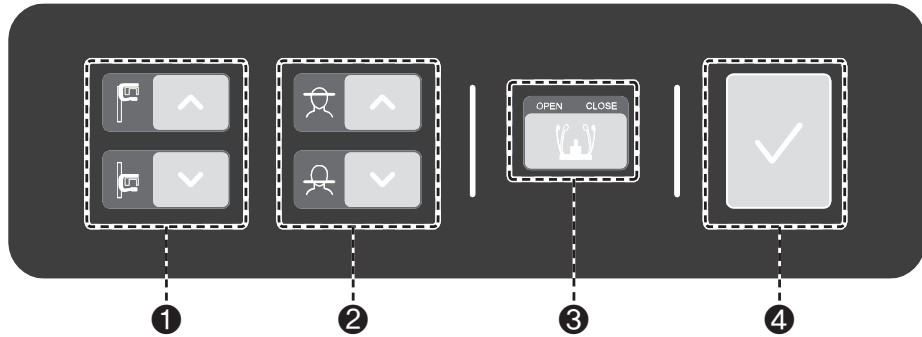

No.	Button	Description
1	Vertical Frame Up/Down button	Adjusts the vertical frame by moving vertically.
2	Horizontal Beam Control button	Positions the horizontal beam in PANO mode.
3	Temple Support OPEN/CLOSE button	Adjusts the temple supports to position the patient.
4	READY/ RETURN button	When pressed, prepares for operation after positioning the patient and configuring the environment settings. Initializes the positioning of the rotating unit.

3. Imaging System Overview

3.3.2 Emergency Stop Switch

During operation, the following emergency situations may occur:

- X-ray emission continues after the exposure switch has been released
- Injury to the patient or damage to the equipment
- Other emergency situations

If a problem occurs during image acquisition, press the red **Emergency Stop Switch** to immediately stop the moving parts and cut off all power to the equipment's electrical components. To reset the **Emergency Stop Switch**, turn it clockwise until it pops up.

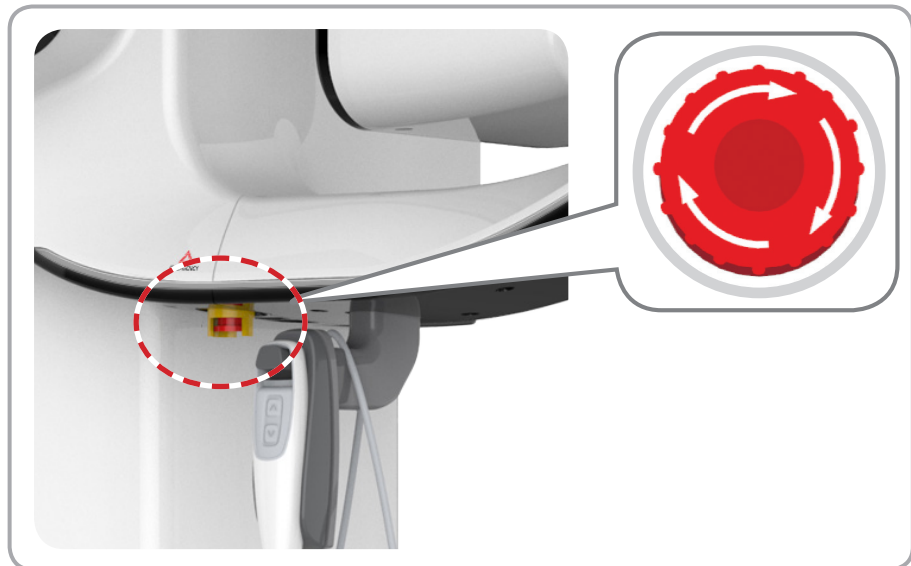

3. Imaging System Overview

3.3.3 Exposure Switch

The exposure switch allows the operator to control image acquisition from outside of the X-ray room.

Press and hold the exposure switch down until acquisition is complete. Premature release of the exposure switch will abort image acquisition.

Pressing the exposure switch activates the orange indicator light to indicate that the X-ray is being emitted.

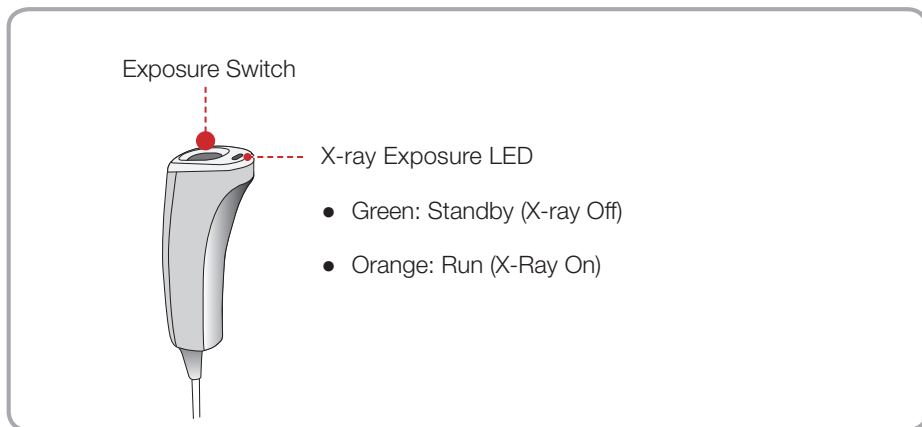









The exposure switch is detachable. Ensure the exposure switch cable is not pulled out from the unit accidentally during operation.

3. Imaging System Overview

3.3.4 Accessories

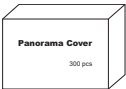
The accessories can be disassembled and cleaned. All accessories that come in direct contact with the patient (bite block, chin rest, and temple supports) should be disinfected with ethanol and wiped with clean towels.

Accessories	Name and Function
	Bite Block
	Temple Supports (1 set)
	Integrated Chin Rest: TMJ, Sinus
	Ear Rod (1 set)
	Nasal Positioner Cover (for CEPH)
	Carpus Plate
	 Integrated Chin Rest Sanitary Vinyl Covers (disposable): Bite Block
	Protractor (1 set): Use to position the body in CEPH mode.

4 | **Imaging Software Overview**

4.1	PC Specifications.....	30
4.2	EasyDent / EzDent-i	32
4.3	Console Software.....	33

4. Imaging Software Overview

Three programs come with this equipment to acquire, process, and view the image:

- **EasyDent / EzDent-i:** 2D viewer, analysis, and patient management
- **Ez3D plus / Ez3D-i:** 3D Viewer and analysis
- **Console software:** PANO / CEPH / CBCT

4.1 PC Specifications



- The PC system plays an important role in image processing and verification. Configure the PC environment to meet the following specifications. If the PC specifications are not met, the image quality may be low.
- Do not place patients near the equipment and PC.

Item	HP	LENOVO
CPU	Intel Xeon E5-1607 3GHz 1600 4C or Faster	Intel Xeon E5-1607 3GHz 1066 or Faster
RAM	16GB DDR3-1600 ECC RAM	16GB DDR3 1600MHz UDIMM
Hard disk drive	1TB SATA 1st HDD	1TB SATA 1st HDD
Graphics board	ZOTAC NVIDIA Geforce GTX780 Ti AMP! D5 3GB	ZOTAC NVIDIA Geforce GTX780 Ti AMP! D5 3GB
Ethernet interface	Broadcom 5761 Gigabit Ethernet	Intel 82579 Gigabit Ethernet
Serial Port (RS232)	HP Serial Port Adapter Kit	1 (On Board)
Power supply	≥ 600 Watts (90 % Efficiency)	≥ 610 Watts (85 % efficient)
Slots	2 PCI Express Gen3 x 16 slots 1 PCI Express Gen3 x 8 slot 1 PCI Express Gen2 x 8 slot 1 PCI Express Gen2 x 4 slot 1 PCI slot	2 PCI Express Gen3 x 16 slot 1 PCI Express Gen3 x 16 slot (x4 Electrical) 1 PCI Express Gen2 x 4 slot 1 PCI slot

4. Imaging Software Overview

Item	HP	LENOVO
CD/DVD drive	DVD-ROM, DVD+/-RW, Blu-Ray	DVD-ROM DVD R/W, Blu-Ray R/W Multi-card reader
Monitor	19" 1280 x 1024 screen resolution	19" 1280 x 1024 screen resolution
Operating system	Windows 7 Professional 64-Bit	Windows 7 Professional 64-Bit
Recommended system	Z420	S30

4. Imaging Software Overview

4.2 EasyDent / EzDent-i

EasyDent / EzDent-i is dental imaging software from Vatech Co. Ltd that manages patient images so you can make faster, more accurate diagnoses. The console software and 3D Viewer are linked with **EasyDent / EzDent-i** making it convenient for the user to use and process necessary images. Various functions can be used so that acquired images can be processed quickly and conveniently from the console software.



Please refer to [5.3 Creating New Patient](#) and [5.4 Retrieving Patient Information](#) and EasyDent / EzDent-i User manual for more information.

4. Imaging Software Overview

4.3 Console Software

Use the console software to configure the imaging environment according to the mode.



- To improve program functions, the console software may change without notice.



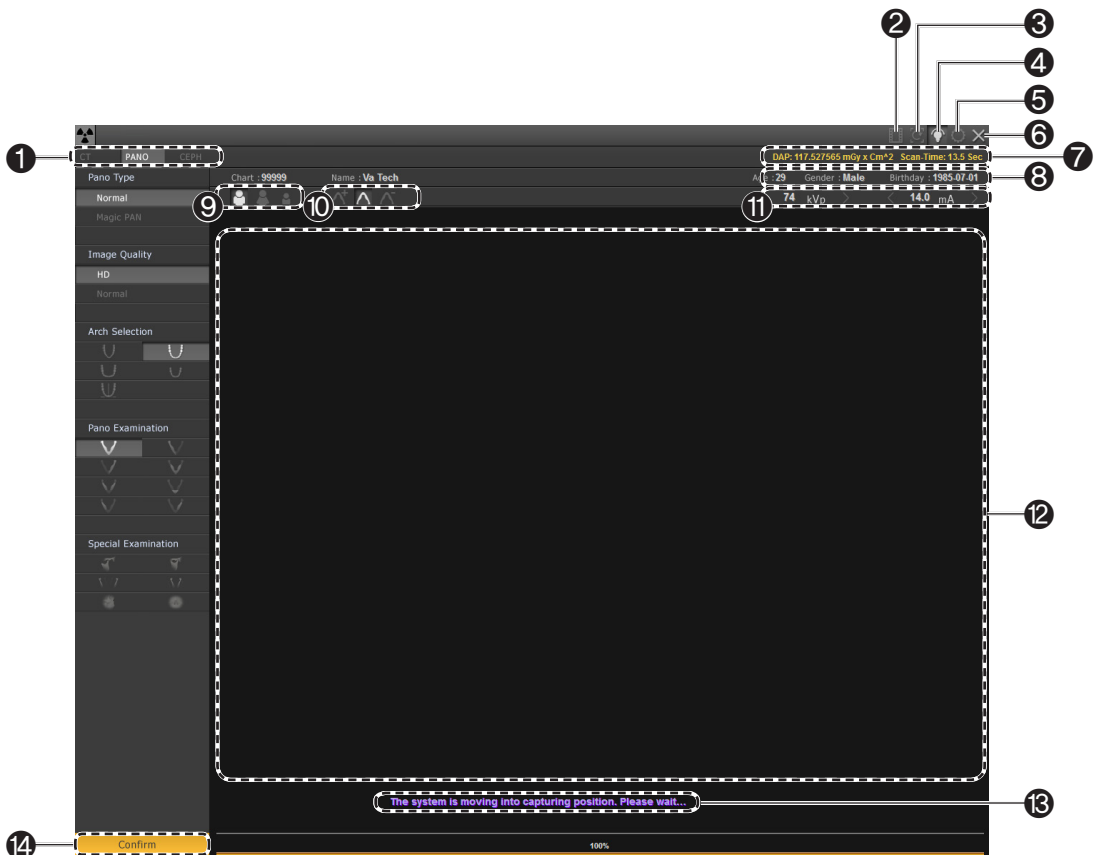

The main screen of the Console Software consists of the following. Each one of the different modes will be described later.



4. Imaging Software Overview

No.	Function	Description
1	Modality	Select scan mode.
2	Phantom Capture	<p>This function is used when the Phantom Jig is being used to acquire images.</p> <hr/> <p>Image acquisition using the Phantom Jig:</p> <ol style="list-style-type: none"> 1. Click Phantom Capture Icon. 2. Select the Modality, followed by OK. 3. Check the parameters displayed in the main GUI window. If correct, click the 'Confirm' button. 4. Align the Phantom Jig, and click the 'Ready' button. 5. Press and hold down the exposure switch.
3	Manual Image Reconstruction	<p>If automatic reconstruction of the image fails, use this function to reconstruct the image manually.</p> <p>(Select Modality and click Search → Reconstruction)</p>
4	Laser Beam On / Off Button	Use this icon to turn the laser beam on or off for patient positioning. This button is enabled when the CONFIRM button is clicked after the imaging environmental parameters are configured.
5	Settings	The control panel appears. Language, automatic settings and DAP can be configured.
6	Exit	The console software ends.
7	Scan Time and DAP Display Window	Upon clicking Confirm , the scan time and estimated DAP value is displayed in this window.
8	Patient Information	Displays information for the selected patient (gender, name, chart number, DOB).

4. Imaging Software Overview

No.	Function	Description
9	Patient Gender	After the patient is selected to be scanned in EzyDent-i, the gender of the patient is displayed with the patient's information. When necessary, it can be selected directly.
10	X-ray Intensity	<p>Select x-ray intensity.</p> <hr/>  <p>Hard, Normal, or Soft may be selected at the doctor's discretion.</p> <p>Soft ≤ Normal ≤ Hard</p> <hr/>
11	Tube Voltage and Tube Current	<p>After the patient is selected to be scanned in EzyDent-i, the default tube voltage and current values are displayed with the patient's information (gender / age). If necessary, it can be adjusted to meet the bone density of the patient. (Use arrow buttons)</p> <hr/>  <p>Please refer to Appendix - Recommended X-ray Exposure Table to set tube voltage/current values according to patient type.</p> <hr/>
12	Imaging Status Window	Preview the imaging status and acquired image.
13	Imaging Guide Window	This displays various text instructions for the operator to follow.
14	Confirm/Ready	<div style="text-align: center; margin-bottom: 10px;">  <p>Confirm</p> </div> <p>After configuring the imaging conditions, the set value will be applied when pressed. By clicking the Confirm button, the Ready button is activated.</p> <div style="text-align: center; margin-bottom: 10px;">  <p>Ready</p> </div> <p>This button is used when all aspects of preparation have done for image acquisition including parameter settings and patient positioning</p>



5

Getting Started

- 5.1 Turning On Equipment38
- 5.2 Running the Image Viewer40
- 5.3 Initiating the Console Software
.....44

5. Getting Started

5.1 Turning On Equipment



- Do not place the patient close to the equipment is on. Doing so may cause injury to the body and damage to equipment.
 - Do not turn on the PC while the equipment is in operation. Doing so may cause an error.
-



- Excessive temperature changes may cause condensation to form on the equipment. When room temperature is reached, turn on the equipment.
 - Equipment rebooting: After turning it off, the equipment may be turned on again after 20 seconds.
 - Warm-up the equipment for at least 5 minutes before the operation. For the best image quality, it is recommended that equipment be warmed-up for 30 minutes or more.
-



If the equipment has not been used for a long time, please leave enough time to warm-up the equipment. It extends the life of the x-ray tube.

The imaging system mainly consists of the imaging equipment and the PC.

Before turning on the equipment, please confirm the equipment and PC correctly installed.

5. Getting Started

1. Turn on the PC.
2. Press the switch that is located under the handle frame to turn on the equipment.

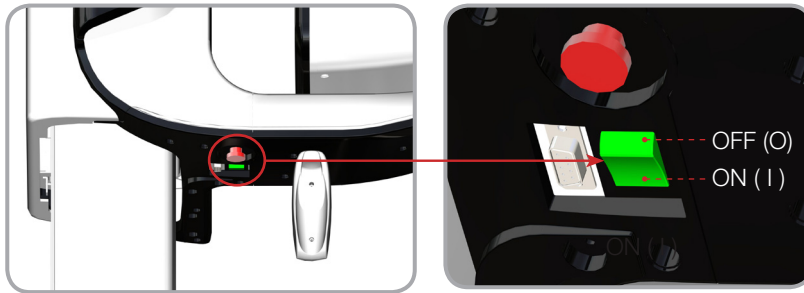

3. Confirm the green LED light at the top of the equipment is on.
4. Plug the license key for the 3D viewer into the PC.

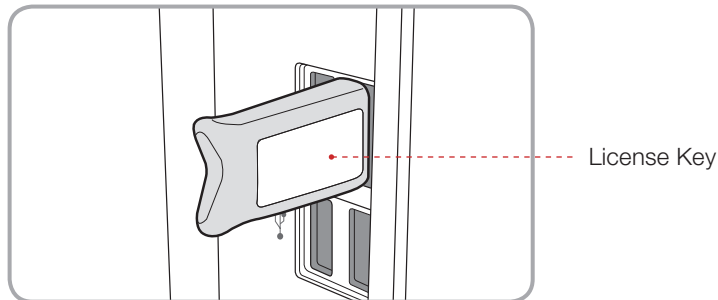

5. Getting Started

5.2 Running the Image Viewer

EasyDent / EzDent-i is a basic imaging platform for all VATECH's dental X-ray equipments. The Imaging Program is interfaced with **EasyDent / EzDent-i**. On your desktop, double-click **EasyDent / EzDent-i** icon. The **EasyDent / EzDent-i** main window will be displayed.



For further details on this subject, refer to the EasyDent / EzDent-i user manual.

5.2.1 Creating a New Patient Record

To create a new patient record, follow the procedure outline below:

EasyDent

A. Click the **Patient** icon on the upper left corner of the EasyDent's main GUI window.

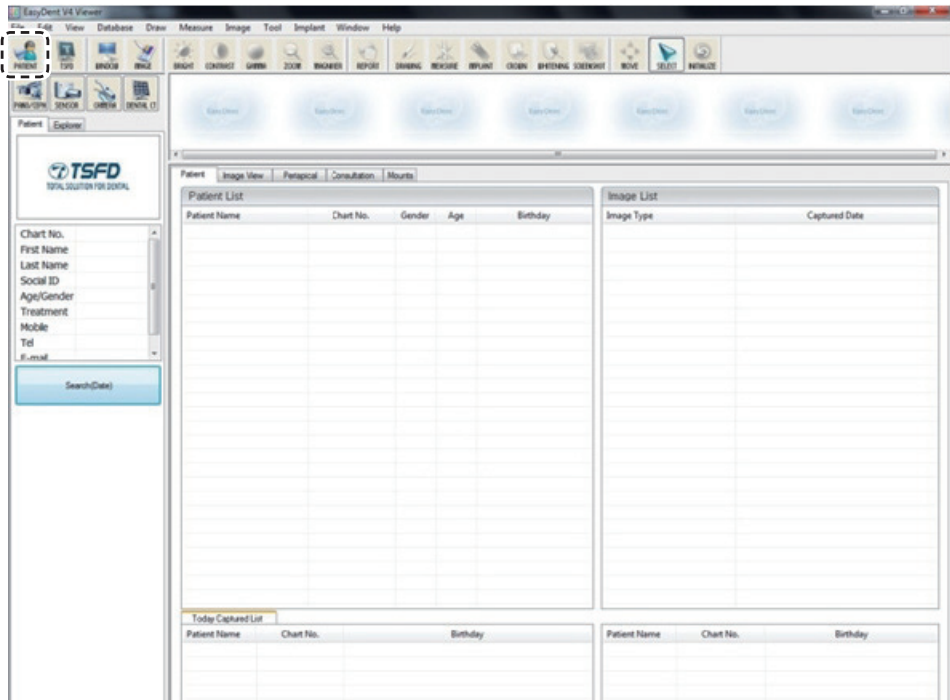

5. Getting Started

B. The following dialog box will open.

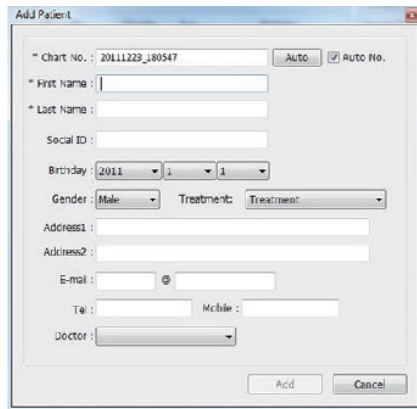

C. Enter the required patient information. **Chart Number, First Name, and Last Name** are required fields which must be filled in. All other fields are optional, but it is recommended that they be filled in.

D. Click **Add** to save the patient record.

EzDent-i

A. Click the **Add Patient** icon from main GUI window.

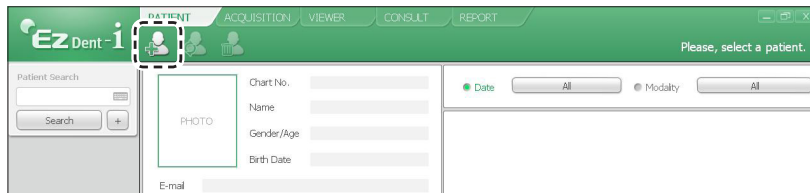

B. Enter the required patient information. The **Chart Number, E-Mail address, First Name, and Last Name** are required fields which must be filled in. (The chart number fills in automatically.)



C. Click **Add** to save the patient record.

5. Getting Started

5.2.2 Retrieving Patient Records

EasyDent

You can search through the patient database using a patient's chart number, their first name, or their last name.

A. On the **Patient information pane**, double-click the **Chart No., First name, or Last name** of the patient and the virtual keyboard will pop up.



B. Enter the **Chart No., First name, or Last name** of the patient by clicking the mouse on the virtual key board and click the **Enter** (The physical keyboard can be used to do the same job).

C. Patient information can be displayed on the **Patient information pane** and **Patient List**.

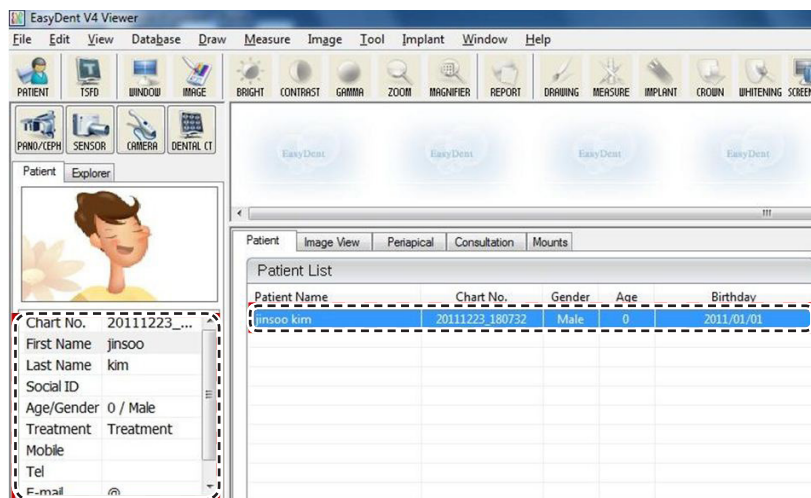

5. Getting Started

EzDent-i

A. Enter the name or chart number of the patient to be searched on the **Search** pane and then click the **Search** button. The information on the patient that fits the search condition appears.

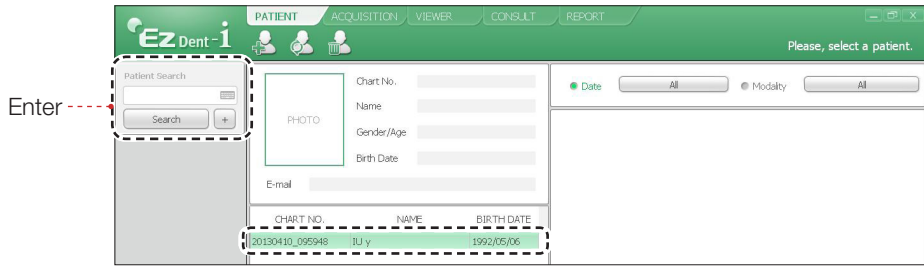

Double-click the Keyboard icon to display the virtual keyboard. You may search patient information using the virtual keyboard.



B. Double-click the patient information to see more details about the patient as shown below.

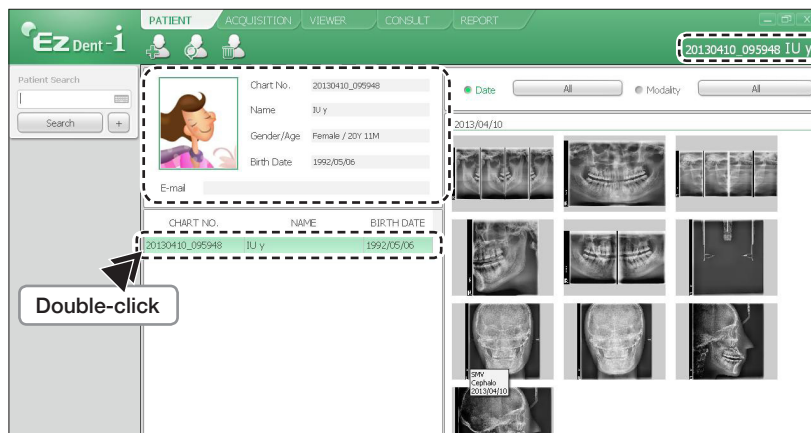

5. Getting Started

5.3 Initiating the Console Software



For a new patient, first register the patient information.

EasyDent

A. First, click the patient information in the patient list, and click the **Dental CT** icon () in the upper left corner of the EasyDent's main window to open the imaging program.



B. The following imaging program window opens. The sole purpose of this window is to control equipment settings and acquire images.

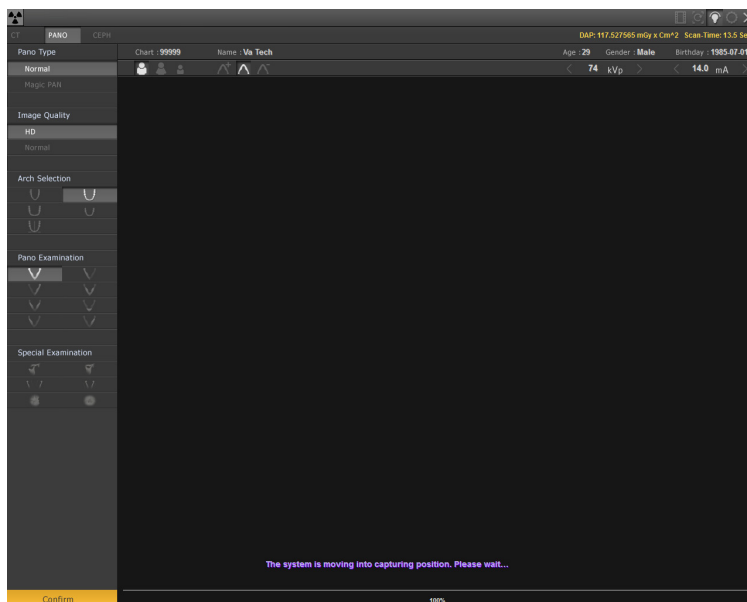

5. Getting Started

EzDent-i

A. Search and select the patient to be captured.



B. Click **Acquisition** and the imaging mode (**CT, Panorama, or Cephalo**).

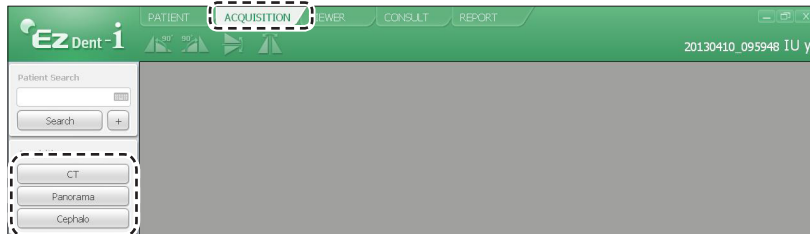

C. The main screen for the selected mode appears. (See **4.3 Imaging Software Overview**). From the main screen, you can configure the imaging parameter settings prior to acquiring an image.

Please proceed to the next chapter.



Refer to chapters 6 - 8 for information regarding image acquisition.















6 | Acquiring PANO images

6.1	Setting Exposure Parameters	53
6.2	Patient Positioning	57
6.3	X-ray Exposure.....	71
6.4	Finishing Scan.....	72
6.5	Confirming Image.....	72

6. Acquiring PANO images

To acquire PANO Images, first **5. Getting Started** must be completed. If **5. Getting Started** is not completed, you must go back to the **5. Getting Started** and finish the step first.

PANO Examination Program

Examination	Arch Selection	Examination Program
PANO EXAMINATION	Narrow, Normal, Wide, Child	 Standard
		 Right
		 Front
		 Left
		 Bitewing
		 Bitewing Incisor
		 Bitewing Right
		 Bitewing Left
SPECIAL EXAMINATION	Orthogonal	 TMJ LAT Open
		 TMJ LAT Close
		 TMJ PA Open
		 TMJ PA Close
		 Sinus LAT
		 Sinus PA

6. Acquiring PANO images

Arch Selection

Examination Program	Image
---------------------	-------

Narrow (Standard): Panoramic image of V-shaped palatal arches (small number of adult females)

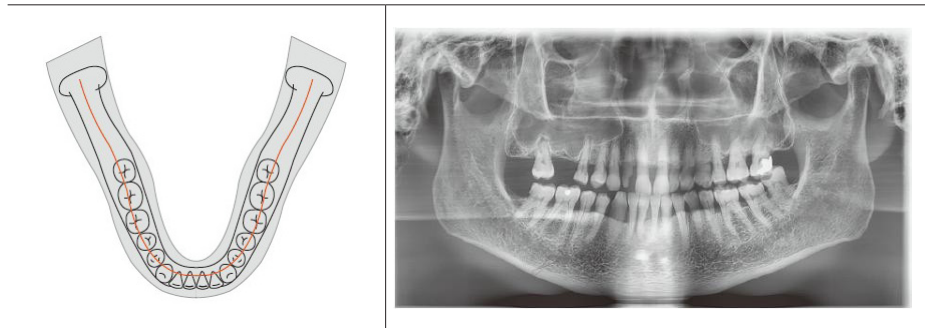



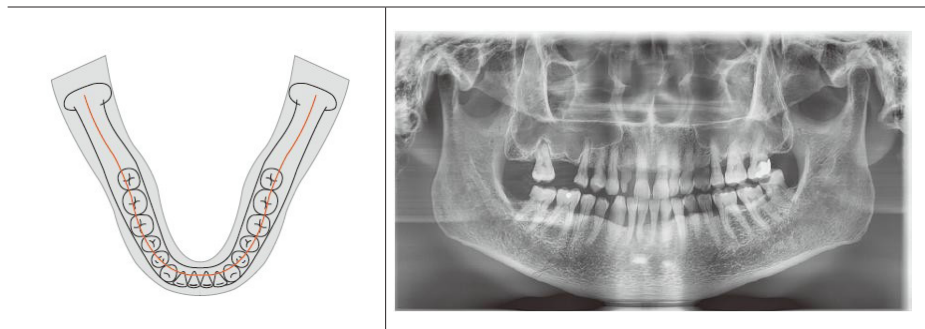

Normal (Standard): Panoramic image of normal adult palatal arches

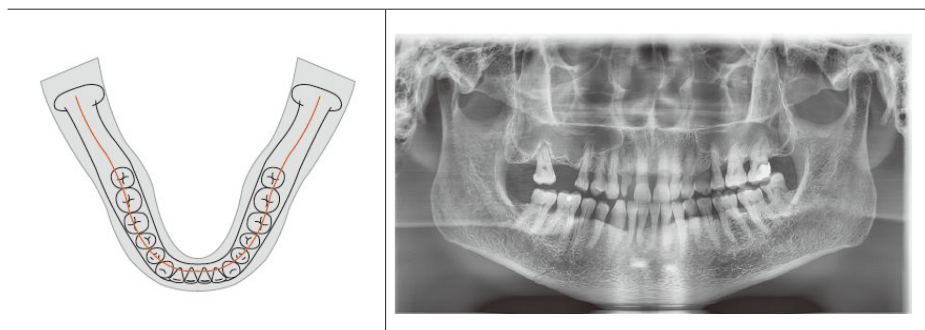

Wide (Standard): Panoramic image of square-shaped palatal arches (some number of adult males)

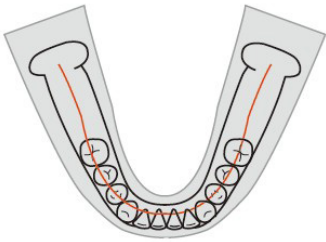

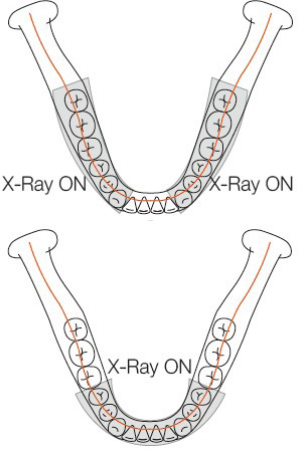
6. Acquiring PANO images

Examination Program	Image
<p>Child (Standard): Panoramic image of child palatal arches, 40% less x-ray dose than in Normal mode.</p>	
	
<p>Bitewing: Imaging from targeted areas of palatal arches; less x-ray dose than in Standard mode.</p>	
	

6. Acquiring PANO images

SPECIAL EXAMINATION

Examination Program	Image
---------------------	-------

Orthogonal (Standard): Panoramic image where the x-ray angle enters vertically in between the teeth so overlapping images are minimized.

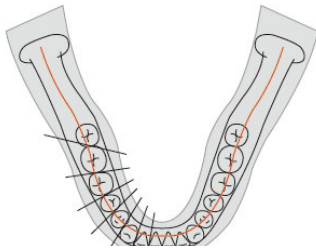

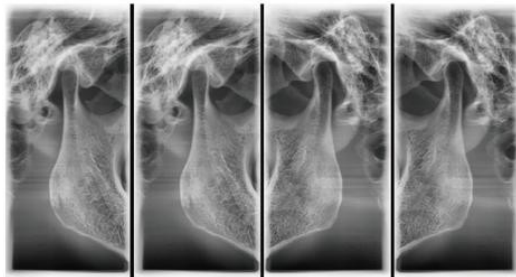
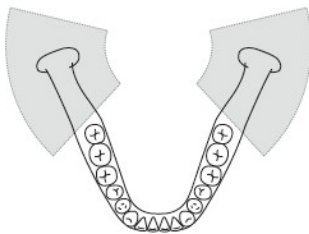

TMJ LAT Open / Close: The acquired image focused on the lateral TMJ area.

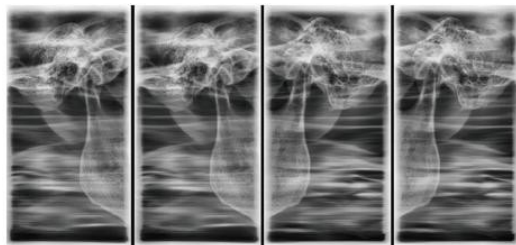
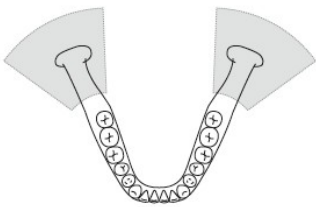

TMJ PA Open / Close: The acquired image focused on the posterior-anterior TMJ area.

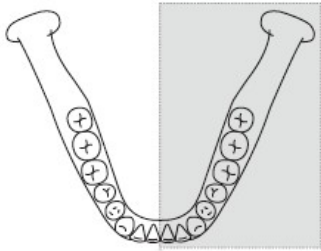
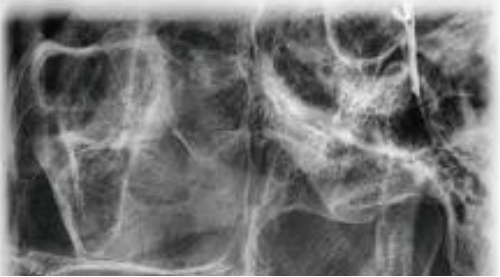
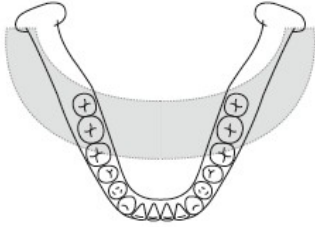

6. Acquiring PANO images

Examination Program	Image
Sinus LAT: The acquired image focused on the lateral Maxillary Sinus area.	
	
Sinus PA: The acquired image focused on the posterior-anterior Maxillary Sinus area.	
	

6. Acquiring PANO images

6.1 Setting Exposure Parameters

Perform the following procedures to select the capture parameters for the specific patient and capture mode. Please refer to [4.3 Console Software](#) for more information.

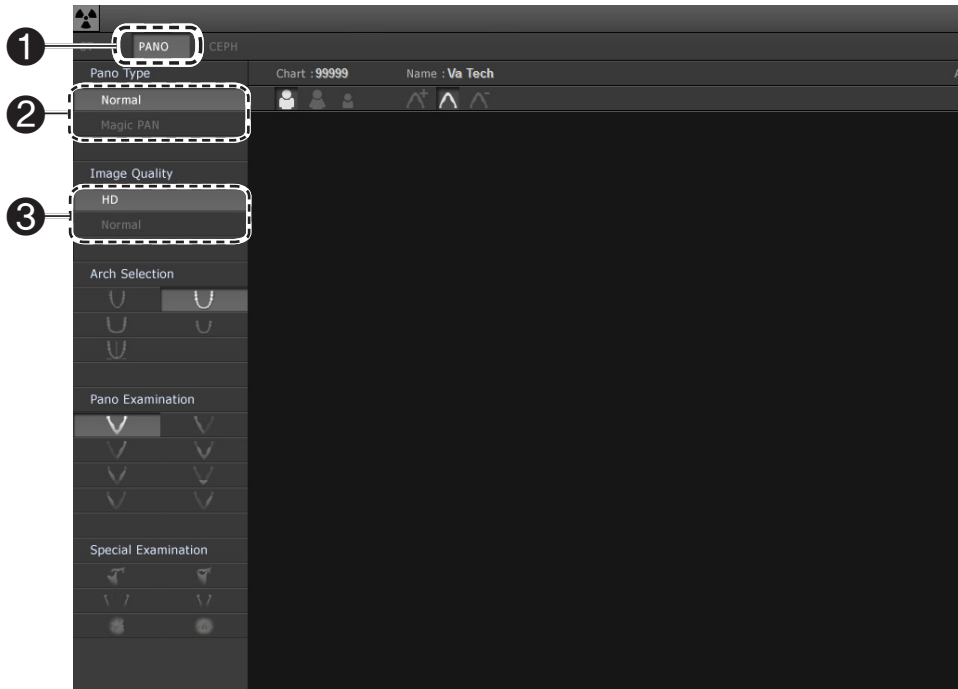

1. Click the PANO button.
2. Select Pano type.

Mode	Description
Normal	This is the normal type.
Magic PAN (Optional)	Reconstruct an image with optimized focus (autofocus) from the entire panorama to acquire high quality images so any errors caused by issues with the patient's position and tooth trajectory will be minimized.







6. Acquiring PANO images

3. Select Image Quality.

Mode	Description
HD	High Definition, High Resolution
Normal	Normal Image











4. Select Arch Selection.







Arch Selection	Description
 Narrow	Panoramic image of V-shaped palatal arches (small number of adult females)
 Normal	Panoramic image of normal adult palatal arches
 Wide	Panoramic image of square-shaped palatal arches (some number of adult males)
 Child	Panoramic image of child palatal arches, 40% less x-ray dose than in Normal mode.
 Orthogonal (Special Examination)	<p>Panoramic image where the x-ray angle enters vertically in between the teeth so overlapping images are minimized.</p> <hr/> <div style="display: flex; align-items: center;">  <p>Select Orthogonal then Special Examination will be activated.</p> </div>

6. Acquiring PANO images

5. Select the Examination Program.

Arch Selection	Description	
Narrow, Normal, Wide, Child	 Standard	 Bitewing
	 Right	 Bitewing Incisor
	 Front	 Bitewing Right
	 Left	 Bitewing Left

6. If Orthogonal is selected from Arch Selection, Special Examination will be selected.

Arch Selection	Description	
Orthogonal	 Sinus LAT	 Sinus PA
	 TMJ LAT Open	 TMJ LAT Close
	 TMJ PA Open	 TMJ PA Close

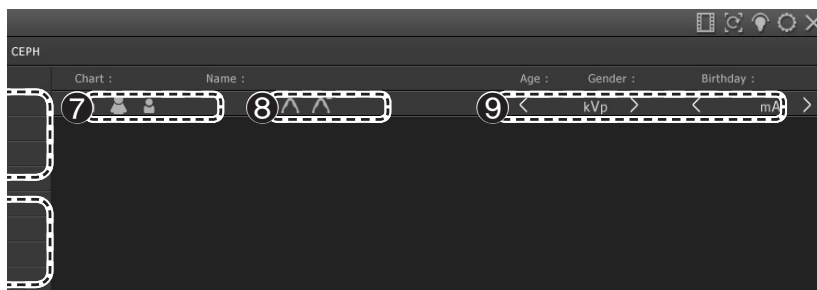

7. The gender of the patient is selected automatically. When necessary, it can be selected manually.
8. Select x-ray intensity.



Hard, Normal, or Soft may be selected at the doctor's discretion.

Soft ≤ Normal ≤ Hard

6. Acquiring PANO images

- The values of tube voltage and current are configured automatically according to the patient's gender and x-ray intensity. Click the arrow button to zoom in. The dose is adjustable by ± 1 kVp and ± 0.1 mA respectively.

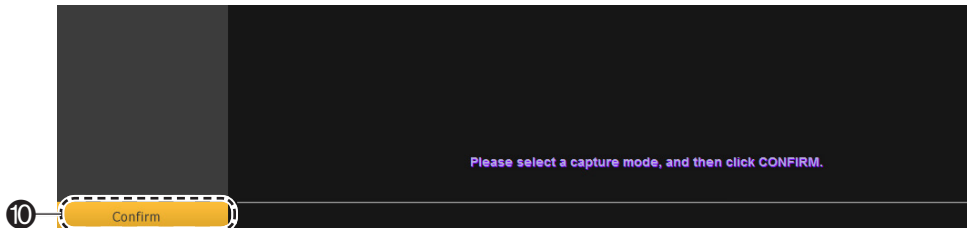

- Once the configuration has been completed, click the **Confirm** button.

When you click **Confirm** button:

- The **Ready** button is activated for X-ray exposure.
- The Rotating unit will move to its initial scanning position.
- Three laser beams will be activated to make patient positioning easier.
- The **Scan Time** and **DAP** values will be shown on the Imaging Status Window.

DAP: 117.527565 mGy x Cm² Scan-Time: 13.5 Sec

- Guide the patient to the equipment and position them.

6. Acquiring PANO images

6.2 Patient Positioning



- Have patients, especially pregnant women and children, wear a lead apron to protect them from residual radiation.
- Be careful not to direct the laser beam into the patient's eyes. Doing so can result in a permanent loss of vision.



- Correct posture reduces the shadow cast by the patient's cervical spine and allows for clear image acquisition.
- Metal implants or bridges may reduce the quality of the images.
- If the laser beam is not correctly positioned, distortion, where the image may be enlarged or reduced, or ghost shadows may occur and lower the image quality so please be careful.



In general, images are acquired when the patient is standing. In special cases, a chair without a backrest (stool) may be used. Do not obstruct the laser beam or the operation of the equipment with the chair.

Getting prepared

1. Ask the patient to remove all the metal objects (glasses, earrings, hair pins, braces, false teeth). Metal objects may induce ghost images and lower the image quality.
2. Ask the patient to wear a lead apron to protect them from residual radiation.
3. Use the **Vertical Frame Up/Down button** or switch option to adjust the equipment to match the height of the patient.



6. Acquiring PANO images

6.2.1 Pano Standard Mode

Patient Positioning

1. Insert the bite block into the chin rest then cover with a sanitary vinyl cover.

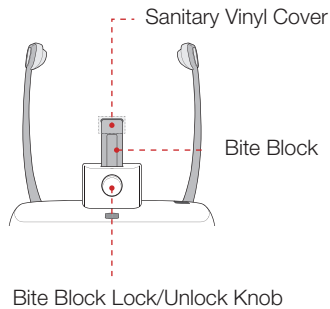

The sanitary vinyl cover is for single use only. It should be replaced after each patient.



Disinfect the chin rest and bite block with ethanol and wipe with a dry towel before the next patient.

2. Use the **Temple Support Open/Close** button on the control panel to widen the temple supports.

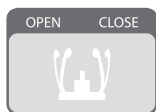

3. Guide the patient to the inside of the equipment.
4. Use the **Vertical Frame Up/Down** button or switch option to adjust the height of the equipment so the patient's chin reaches the chin rest.

6. Acquiring PANO images

5. Guide the patient to stand in the center of the equipment and direct them to remain in the position outlined below.
 - Two hands: Hold the handles of the equipment tightly.
 - Chest: Press against the equipment.
 - Two feet: Keep both feet close to the inside of the base.
 - Shoulders: Keep your shoulders relaxed and balanced.
 - Cervical Spine: Straighten your body and stand still.
6. Direct the patient to correctly bite into the bite block groove with their front teeth.
7. Turn the knob to fix the bite block in place.
8. Direct the patient to maintain the posture as described below.
 - Mouth: Close your mouth.
 - Tongue: Touch the roof of your mouth.
 - Two eyes: Close your eyes.

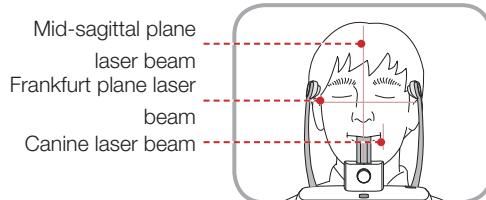

Edentulous Patient Positioning

1. Remove the bite block from the chin rest.

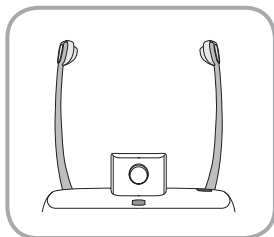

2. Use the **Temple Support Open/Close** button on the control panel to widen the temple supports.

6. Acquiring PANO images

3. Guide the patient to the inside of the equipment.
4. Use the Vertical Frame Up/Down button or switch option to adjust the height of the equipment so the patient's chin reaches the chin rest.
5. Guide the patient to stand in the center of the equipment and direct them to remain in the position outlined below.
 - Two hands: Hold the handles of the equipment tightly.
 - Chest: Press against the equipment.
 - Two feet: Keep both feet close to the inside of the base.
 - Shoulders: Keep your shoulders relaxed and balanced.
 - Cervical Spine: Straighten your body and stand still.
6. Direct the patient to maintain the posture as described below.
 - Mouth: Close your mouth.
 - Tongue: Touch the roof of your mouth.
 - Two eyes: Close your eyes.



6. Acquiring PANO images



Correct posture reduces the shadow cast by the patient's cervical spine and allows for clear image acquisition.

During image acquisition, direct the patient to maintain the posture as described below.

- Two hands: Hold the handles of the equipment tightly.
- Chest: Press against the equipment.
- Two feet: Keep both feet close to the inside of the base.
- Shoulders: Keep your shoulders relaxed and balanced.
- Cervical Spine: Straighten your body and stand still.
- Mouth: Bite the bite block and close your mouth.
- Tongue: Touch the roof of your mouth.
- Two eyes: Close your eyes.

Ask the patient to maintain their position and to not move until the image acquisition is completed.

Laser Beam Positioning



Be careful not to shine the laser beam directly into the person's eyes. Doing so may result in vision loss.



If the laser beam is not correctly positioned, distortion, where the image may be enlarged or reduced, or ghost shadows may occur and lower the image quality. Be sure to align the laser beam properly.

1. Align the vertical beam with the center of the face. (To prevent horizontal expansion of the image)

- Align the horizontal beam in a straight line with the Frankfurt line on the patient's face. Use the Horizontal Beam button on the control panel to position it. Check to see that the horizontal beam aligns with the patient's face horizontally.

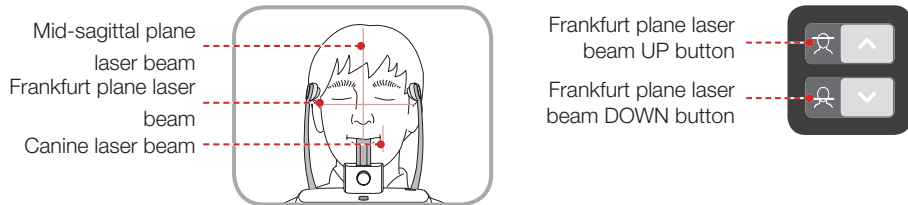

- Direct the patient to smile and align the canine teeth beam with the center of the canines. Use the Canine Teeth Beam level to adjust the position of the beam.

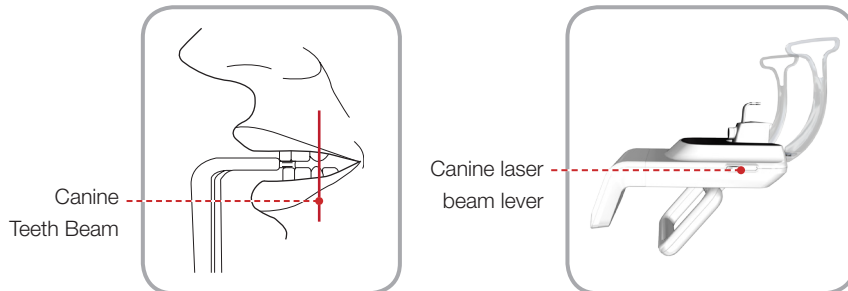

Finishing Patient Positioning

- After checking the positions of the patient and the laser beam, click the **Temple Support Open/Close** button on the control panel to prevent the patient's head from moving.

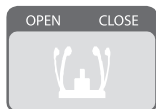

- Click the **READY** button. The x-ray exposure has not started yet.
- Now go to **6.3 X-ray Exposure** to begin operation.

6.2.2 TMJ Open Mode

Acquire the TMJ Close image after the TMJ Open image has been acquired.



Steps for TMJ Mode

TMJ Open positioning > Align Laser Beam > X-ray Exposure > TMJ Close positioning > Align Laser Beam > X-ray Exposure



Disinfect the chin rest and bite block with ethanol and wipe with a dry towel before the next patient.

TMJ Open Positioning

1. Insert the integrated chin rest into the equipment.

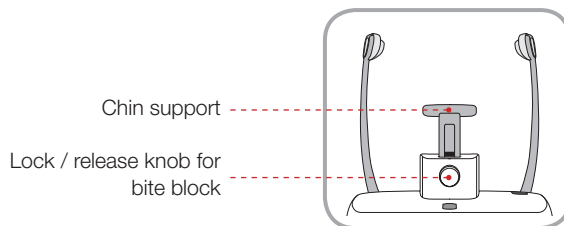

Disinfect the chin rest with ethanol and wipe with a dry towel before the next patient.

2. Use **Temple Support Open/Close** button on the control panel to widen temple supports.



3. Guide the patient to the inside of the equipment.

6. Acquiring PANO images

4. Use the **Vertical Frame Up/Down** button or switch option to adjust the height of the equipment so the patient's chin reaches the chin rest.
5. Guide the patient to stand in the center of the equipment and direct them to remain in the position outlined below.
 - Two hands: Hold the handles of the equipment tightly.
 - Chest: Press against the equipment.
 - Two feet: Keep both feet close to the inside of the base.
 - Shoulders: Keep your shoulders relaxed and balanced.
 - Cervical Spine: Straighten your body and stand still.
6. After adjusting the integrated chin rest, turn the knob to fix the chin rest.
7. Guide the patient to press the base of their nose (acanthion point) against the chin rest and tilt their head forward about -5° . At this point, make sure the patient's jaw does not touch the equipment.



If the jaw touches the equipment it is difficult to maintain the proper position to get good images.

Be careful the patient does not touch the equipment with their jaw.

8. Direct the patient to maintain the posture as described below.
 - Mouth: After swallowing once, open your mouth as wide as possible.
 - Tongue: Touch the roof of your mouth.
 - Two eyes: Close your eyes.

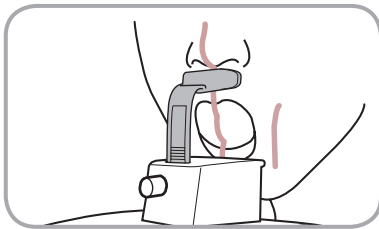

- As shown in the picture, the support unit of the integrated chin rest should touch the patient's acanthion point.
 - Ask the patient to maintain their position until the operation is completed.
-

6. Acquiring PANO images

Laser Beam Positioning



Be careful not to shine the laser beam directly into the person's eyes.
Doing so may result in vision loss.



If the laser beam is not correctly positioned, distortion, where the image may be enlarged or reduced, or ghost shadows may occur and lower the image quality.
Be sure to align the laser beam properly.

1. Align the vertical beam with the center of the face. (To prevent horizontal expansion of the image)
2. Align the horizontal beam in a straight line with the Frankfort line on the patient's face. Use the Horizontal Beam button on the control panel to position it. Check to see that the horizontal beam aligns with the patient's face horizontally.
3. Align the Canine Teeth Beam with the center of the patient's canines. Use the Canine Teeth Beam level to adjust the position of the beam.

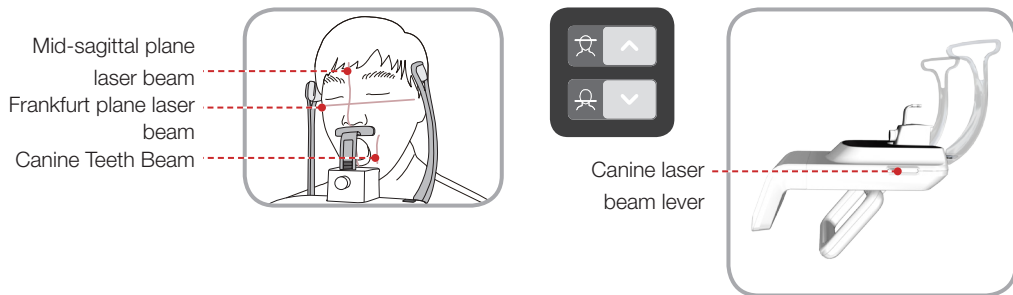

6. Acquiring PANO images

Finishing Patient Positioning

1. After checking the positions of the patient and the laser beam, click the **Temple Support Open/Close** button on the control panel to prevent the patient's head from moving.



2. Click the **READY** button. The x-ray exposure has not started yet.
3. Now go to **6.3 X-ray Exposure** to begin operation.

6.2.3 TMJ Close Mode

Acquire the TMJ Close image after the TMJ Open image has been acquired.



Steps for TMJ Mode

TMJ Open positioning > Align Laser Beam > X-ray Exposure > TMJ Close positioning > Align Laser Beam > X-ray Exposure



Correct posture reduces the shadow cast by the patient's cervical spine and allows for clear image acquisition.

TMJ Close Positioning

1. After TMJ Open image is acquired, a "Do you want to take the TMJ Close image continuously?" message is displayed. Press the Confirm button to begin TMJ Close Mode.
2. After adjusting the integrated chin rest, turn the knob to fix the chin rest.
3. Guide the patient to press the base of their nose (acanthion point) against the chin rest and tilt their head forward about -5° . At this point, make sure the patient's jaw does not touch the equipment.

6. Acquiring PANO images



If the jaw touches the equipment it is difficult to maintain the proper position to get good images.

Be careful the patient does not to touch the equipment with their jaw.

4. Direct the patient to maintain the posture as described below.

- Mouth: After swallowing once, open your mouth as wide as possible.
- Tongue: Touch the roof of your mouth.
- Two eyes: Close your eyes.

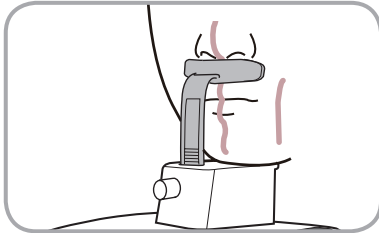

- As shown in the picture, the support unit of the integrated chin rest should touch the patient's acanthion point.
 - Ask the patient to maintain their position until the operation is completed.
-

Laser Beam Positioning

This is the same as for TMJ Open mode.

Finishing Patient Positioning

This is the same as for TMJ Open mode.

6. Acquiring PANO images

6.2.4 Sinus Mode

Patient Positioning

1. Insert the integrated chin rest into the equipment.



Disinfect the chin rest with ethanol and wipe with a dry towel before the next patient.

2. Use **Temple Support Open/Close** button on the control panel to widen temple supports.

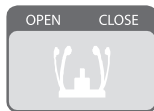

3. Guide the patient to the inside of the equipment.
4. Use the **Vertical Frame Up/Down** button or switch option to adjust the height of the equipment so the patient's chin reaches chin rest.
5. Guide the patient to stand in the center of the equipment and direct them to remain in the position outlined below.
 - Two hands: Hold the handles of the equipment tightly.
 - Chest: Press against the equipment.
 - Two feet: Keep both feet close to the inside of the base.
 - Shoulders: Keep your shoulders relaxed and balanced.
 - Cervical Spine: Straighten your body and stand still.
6. After adjusting the integrated chin rest, turn the knob to fix the chin rest.

6. Acquiring PANO images

7. Position the integrated chin rest so it rests directly under the patient's lower lip.

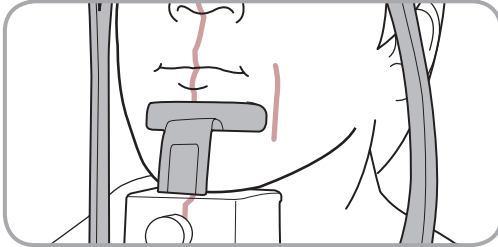

8. Direct the patient to maintain the posture as described below.

- Head: Tilt the head back 10° - 15°.
- Mouth: Close your mouth.
- Tongue: Touch the roof of your mouth.
- Two eyes: Close your eyes.

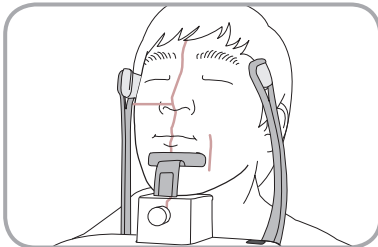

Ask the patient to maintain their position until the operation is completed.

6. Acquiring PANO images

Laser Beam Positioning



Be careful not to shine the laser beam directly into the person's eyes. Doing so may result in vision loss.



If the laser beam is not correctly positioned, distortion, where the image may be enlarged or reduced, or ghost shadows may occur and lower the image quality. Be sure to align the laser beam properly.

1. Align the vertical beam with the center of the face. (To prevent horizontal expansion of the image)
2. Tilt the patient's head back 10° - 15° then align the horizontal beam with tip of the nose. Use the Horizontal Beam button on the control panel to position it.
3. Align the Canine Teeth Beam with the center of the patient's canines. Use the Canine Teeth Beam level to adjust the position of the beam.

Finishing Patient Positioning

1. After checking the positions of the patient and the laser beam, click the **Temple Support Open/Close** button on the control panel to prevent the patient's head from moving.

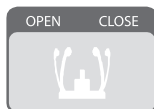

2. Click the **READY** button. The x-ray exposure has not started yet.
3. Now go to **6.3 X-ray Exposure** to begin operation.

6. Acquiring PANO images

6.3 X-ray Exposure

After the aligning the laser beam, the x-ray scan can begin.



The user must comply with the laws of the country regarding the usage of the medical equipment.



Direct the patient to close their eyes during operation.

To acquire optimized images, direct the patient to hold their breath and to not swallow. Also, direct them to not move.

1. Direct the patient to close their eyes.
2. Close the door when leaving the x-ray room. Observe the patient during operation and check the imaging status.
3. Begin acquisition by pressing the exposure switch. Continue to press the exposure switch until the image has been acquired.

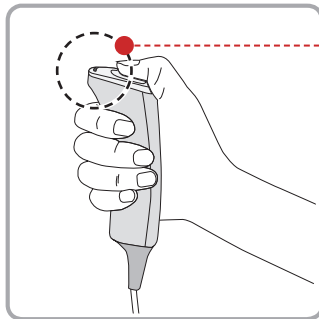

Orange: X-ray On

During x-ray exposure, the status appears as follows.

- The exposure switch LED light is orange.
- The exposure switch LED light on top of the equipment is orange.
- An alert will sound to indicate that x-ray emission is currently underway.
- In the console software, the x-ray On in yellow changes.



6. Acquiring PANO images

6.4 Finishing Scan

1. Open the temple supports and guide the patient out of the equipment.
2. Remove the hygiene cover from the bite block.
3. Press  (**Return**) button to bring the Rotating Unit back to its initial position.

6.5 Confirming Image

Acquired images can be reconstructed and converted to DICOM format.

The exported images can be confirmed in EasyDent / EzDent-i.



Please refer to the EasyDent / EzDent-i User manual for more information.

1. The images are transferred to EasyDent / EzDent-i automatically.
2. The images are automatically saved if automatic save is configured in the basic settings. If automatic save is not configured in the basic settings, click the **Save to DB** button to save the images.
3. Double-click the image to confirm in the Patient list.

7





Acquiring CEPH images

7.1	Setting Exposure Parameters	76
7.2	Patient Positioning	79
7.3	X-ray Exposure.....	89
7.4	Finishing Scan.....	90
7.5	Confirming Image.....	90

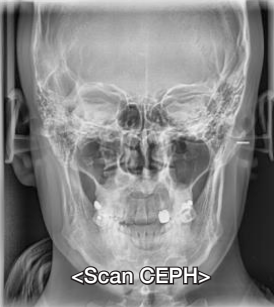

7. Acquiring CEPH images

To acquire images, **5. Getting Started** should be completed first. If **5. Getting Started** is not completed, return to that section and finish the step first.

CEPH Imaging Software

Examination	Image	Description
PA		<ul style="list-style-type: none"> • The radiation is directed from the posterior of the skull to the anterior. • Use to examine cranial diseases, trauma and congenital malformations. • Used to assess the growth of lateral side of the face. It is also useful to examine the ramus mandibulae, the posterior region of the third largest molar in the lower jaw, and the side wall of the maxillary sinus, and the frontal sinus, antrum ethmoidale, olfactory pits and optic disc pits. • Measure the angles formed by the connecting lines between the cranial measurement points to further assess the growth of the facial region. It is widely used in Orthodontics and Oral and Maxillofacial Surgery.
		
Lateral		
		

7. Acquiring CEPH images

Examination	Image	Description
SMV	 <p data-bbox="487 691 628 720"><Scan CEPH></p>	<p data-bbox="720 430 1138 681">Use to study the base of the skull, horizontal angulation of the mandibular condylar axis, sphenoidal sinus, curvature of the lower jaw, side wall of the maxillary sinus, and zygomatic arch fractures. Also useful to study the inner and outer alar plates and holes at base of the skull.</p>
Waters View	 <p data-bbox="466 909 648 938"><OneShot CEPH></p>	<p data-bbox="720 778 1145 933">Use to study the frontal sinus, antrum ethmoidale, optic disc pit, frontozygomatic suture, nasal cavity, coronoid process between the upper jaw and zygomatic arch.</p>
CARPUS	 <p data-bbox="466 1213 648 1242"><OneShot CEPH></p>	<p data-bbox="720 1087 1090 1145">Use to assess hand bone age and compare with changes in the skull.</p>

7. Acquiring CEPH images

7.1 Setting Exposure Parameters

Perform the following procedures to select the capture parameters for the specific patient and capture mode. Please refer to [4.3 Console Software](#) for the more information.

Steps for Configuring Imaging Conditions

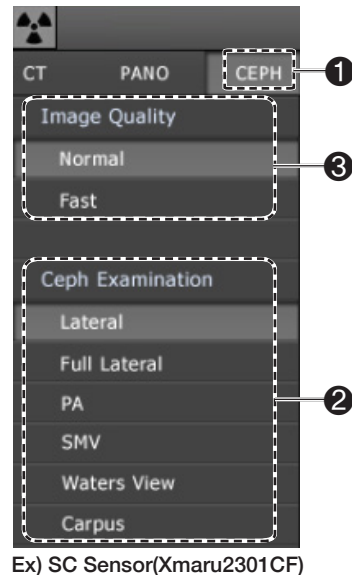
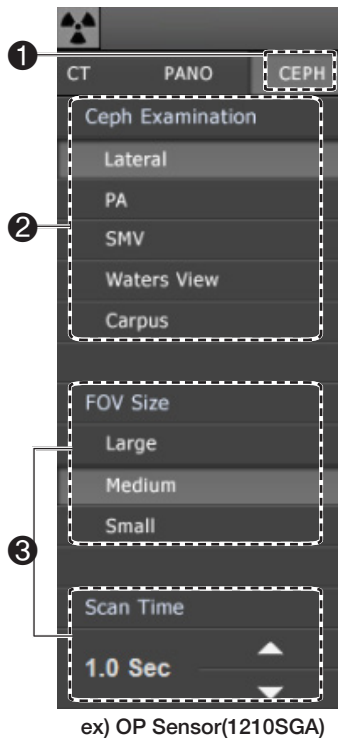

Ex) SC Sensor(Xmaru2301CF)

1. Click the **CEPH** button.
2. Select the examination program under **Ceph Examination** – Lateral, Full Lateral, PA, SMV, Waters View, Carpus.



Full Lateral is optional and available for Scan CEPH models only.

7. Acquiring CEPH images

- Do the selections that follow depending on the Ceph sensor.

OneShot Ceph sensor

- **FOV Size:** Select the FOV size.

FOV	Details	Model
Large : 12x10 (inches) : 30.48x25.40 (cm)	Full size	OP(1210SGA)
Medium : 9x10 (inches) : 22.86x25.40 (cm)	Region of the no interest of the rear part of the head is eliminated to minimize the X-ray exposure area.	OP(1210SGA) / OS(910SGA)
Small : 8x8 (inches) : 20.32x20.32 (cm)	For Child	OP(1210SGA) / OS(910SGA)

- **Scan Time:** Scan time can be adjusted by resolution of 0.1 sec in the range of 0.7 sec to 1.2 sec.

Scan Ceph Sensor

- **Image Quality:** Normal or Fast(optional).

- The gender of the patient is selected automatically. When necessary, it can be selected directly.
- Select x-ray intensity.



Hard, Normal, or Soft may be selected at the doctor's discretion. Soft \leq Normal \leq Hard

- The values of tube voltage and current are configured automatically according to the patient's gender and x-ray intensity. Click the arrow button to zoom in. The dose is adjustable by ± 1 kVp and ± 0.1 mA respectively.

7. Acquiring CEPH images

7. Once the configuration has been completed, click the **Confirm** button.

When you click **Confirm** button:

- The **Ready** button is activated for X-ray exposure.



- The **Scan Time** and **DAP** values will be shown on the Imaging Status Window.

DAP: 117.527565 mGy x Cm^2 Scan-Time: 13.5 Sec

8. Guide the patient to the equipment and position them.

7. Acquiring CEPH images

7.2 Patient Positioning



- Have patients, especially pregnant women and children, wear a lead apron to protect them from residual radiation.
 - Be careful not to direct the laser beam into the patient's eyes. Doing so can result in a permanent loss of vision.
-



- Metal implants or bridges may reduce the quality of the images.
 - If the laser beam is not correctly positioned, distortion, where the image may be enlarged or reduced, or ghost shadows may occur and lower the image quality so please be careful.
 - Ensure that the nasal positioner left unfolded, before adjusting the ear rods in the proper direction.
-



Correct positioning is an important factor in capturing the best possible image.



Although the illustrations and explanations on patient's posture and device usage are based on the OS / OP models (one shot-type sensor), those for the SC (scan type) model should be the same.

7. Acquiring CEPH images

Getting Prepared

1. Ask the patient to remove all the metal objects (glasses, earrings, hair pins, braces, false teeth). Metal objects may induce ghost images and lower the image quality.
2. Ask the patient to wear a lead apron to protect them from residual radiation.
3. Use the **Vertical Frame Up/Down** button or switch option to adjust the equipment to match the height of the patient.



7.2.1 Lateral / Full Lateral Mode



Full Lateral mode is available for SCAN CEPH model only.

1. Leave enough space between the ear rods.

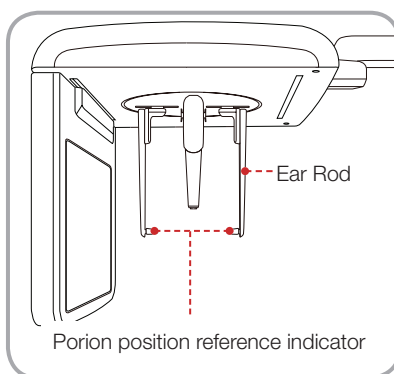

Use the Porion position reference indicator that appears in the acquired image to easily confirm the location of Porion.

2. Guide the patient to the CEPH unit.
3. Direct the patient to relax their neck and shoulders and stand upright.

7. Acquiring CEPH images

4. Use the **Vertical Frame Up/Down** button or switch option to adjust the height of the CEPH Unit to approximately match the height of the patient.

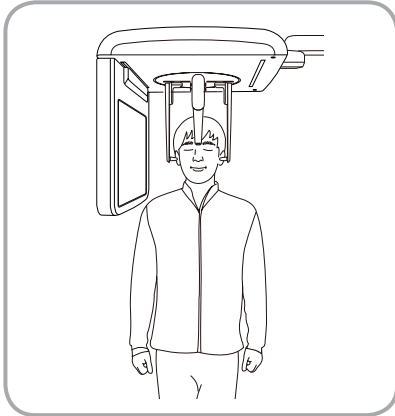

5. During operation, properly align the ear rods with the patient's ears so their head does not move.



After adjusting the height of the column, align the ear rods and nasal positioner with the patient.

6. Align horizontally so the patient's Frankfort line is parallel with the floor.

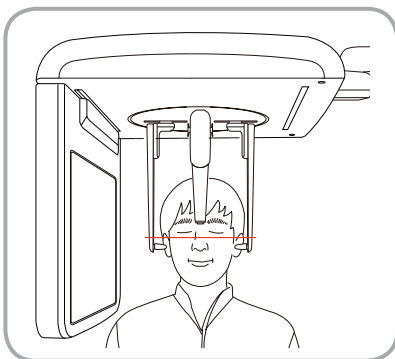

7. Direct the patient to swallow first before closing their mouth and to remain in their current position until image acquisition is complete.
8. Click the **READY** button. The x-ray exposure has not started yet.
9. Now go to **7.3 X-ray Exposure** to begin operation.

7. Acquiring CEPH images

7.2.2 Frontal (PA) mode

1. Rotate the ear rods 90° clockwise from their initial position as shown in the figure

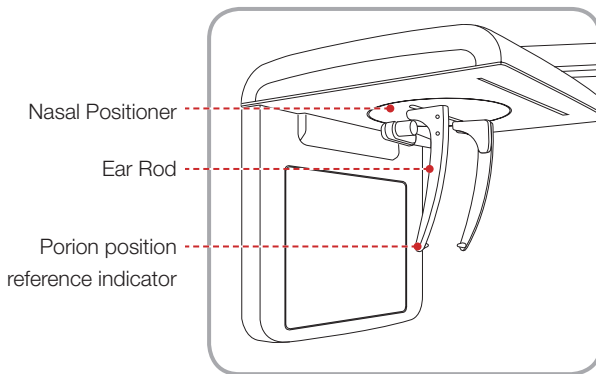

Use the Porion position reference indicator that appears in the acquired image to easily confirm the location of Porion.

2. Fold the nasal positioner up. The nasal positioner is not used in Frontal mode.
3. Guide the patient to the CEPH unit.
4. Ask the patient to stand upright facing the sensor. Make sure that the patient's shoulders are level and that his/her neck is relaxed.

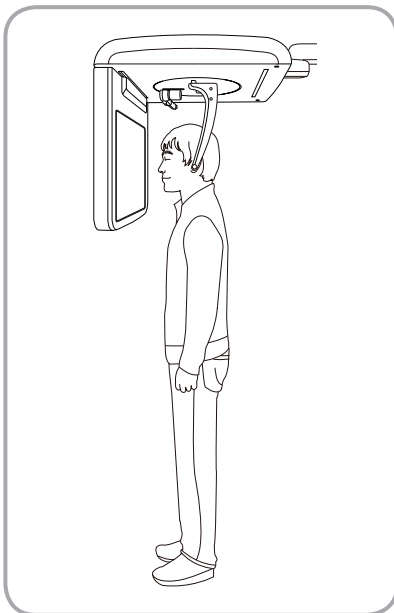

7. Acquiring CEPH images

5. Use the **Vertical Frame Up/Down** button or switch option to adjust the height of the CEPH Unit to approximately match the height of the patient.
6. During operation, properly align the ear rods with the patient's ears so their head does not move.



After adjusting the height of the column, align the ear rods and nasal positioner with the patient.

7. Align horizontally so the patient's Frankfort line is parallel with the floor.

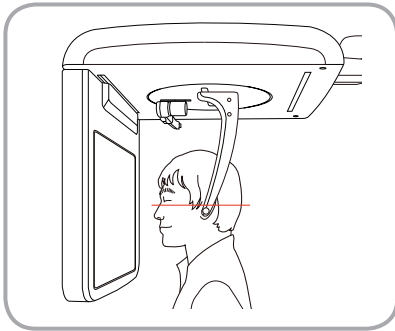

8. Direct the patient to swallow first before closing their mouth and to remain in their current position until image acquisition is complete.
9. Click the **READY** button. The x-ray exposure has not started yet.
10. Now go to [7.3 X-ray Exposure](#) to begin operation.

7. Acquiring CEPH images

7.2.3 SMV Mode

1. Rotate the ear rods 90° clockwise from their initial position as shown in the figure.

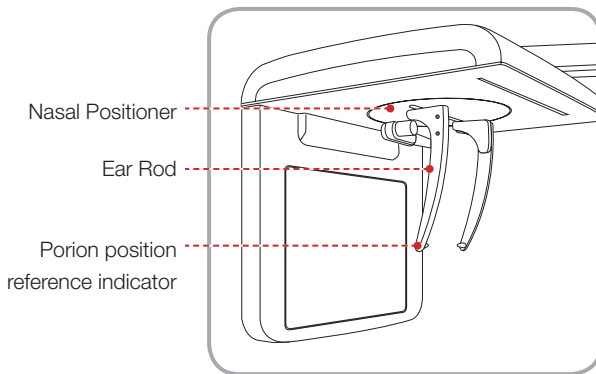

Use the Porion position reference indicator that appears in the acquired image to easily confirm the location of Porion.

2. Fold the nasal positioner up. The nasal positioner is not used in Frontal mode.
3. Guide the patient to the CEPH unit.
4. Guide the patient to face the X-ray tube and stand upright.

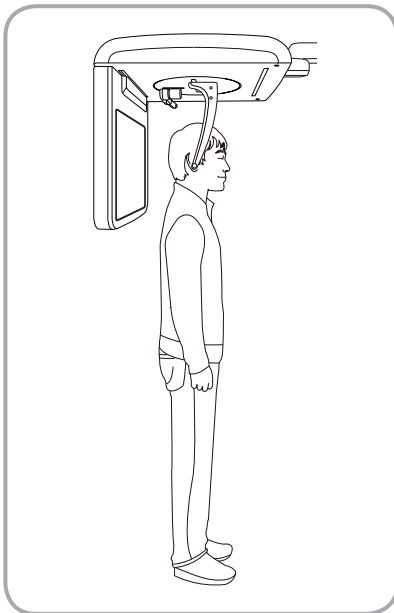

7. Acquiring CEPH images

5. Use the Vertical Frame Up/Down button or switch (option) to adjust the height of the CEPH Unit to match the height of the patient.
6. During operation, properly align the ear rods with the patient's ears so their head does not move.



After adjusting the height of the column, align the ear rods and nasal positioner with the patient.

7. Carefully tilt the patient's head back and adjust so their Frankfort line is parallel with the floor.
8. Direct the patient to swallow first before closing their mouth and to remain in their current position until image acquisition is complete.

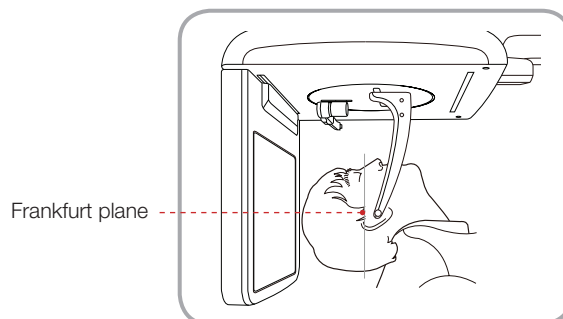

9. Click the **READY** button. The x-ray exposure has not started yet.
10. Now go to [7.3 X-ray Exposure](#) to begin operation.

7. Acquiring CEPH images

7.2.4 Waters View Mode

1. Rotate the ear rods 90° clockwise from their initial position as shown in the figure.

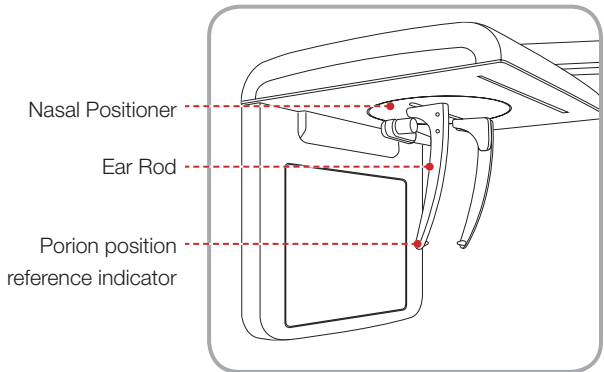

Use the Porion position reference indicator that appears in the acquired image to easily confirm the location of Porion.

2. Fold the nasal positioner up. The nasal positioner is not used in Frontal mode.
3. Guide the patient to the CEPH unit.
4. Ask the patient to stand upright facing the sensor. Make sure that the patient's shoulders are level and that his/her neck is relaxed.
5. Use the **Vertical Frame Up/Down** button or switch option to adjust the height of the CEPH Unit to approximately match the height of the patient.
6. During operation, properly align the ear rods with the patient's ears so their head does not move.



After adjusting the height of the column, align the ear rods and nasal positioner with the patient.

7. Acquiring CEPH images

7. Direct the patient to swallow and close their mouth, and guide the patient's head back 30° - 40° . Direct the patient to remain in the current position until image acquisition is complete.

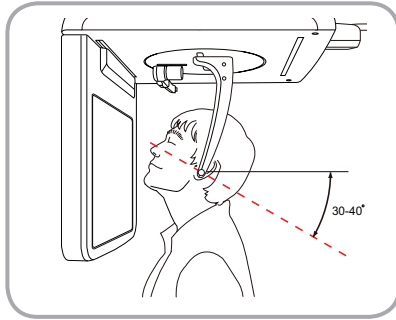

8. Click the **READY** button. The x-ray exposure has not started yet.
9. Now go to [7.3 X-ray Exposure](#) to begin operation.

7.2.5 CARPUS Mode

■ Installing the Carpus Plate

1. Align the end of the nasal positioner to the carpus plate groove so it is attached to the nasal positioner.

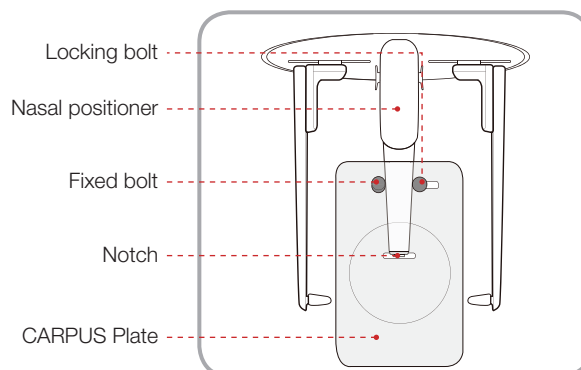

7. Acquiring CEPH images

2. Pull the locking bolt to the left (in the direction of the nasal positioner). After securing the bolt in place, turn to the left to tighten.

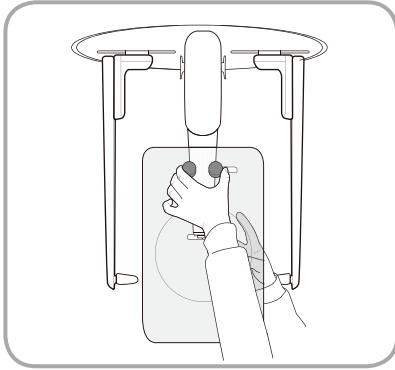

3. Confirm that carpus plate is safely mounted.

■ Patient Positioning

1. Have the patient spread their right hand and locate the carpus plate. Make sure they do not to bend their fingers.

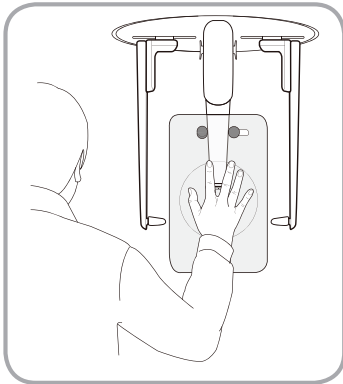

2. Ask the patient to close their eyes and stand still until the image acquisition is completed.



Make sure the patient's fingers do not to block the positioner. Doing so may reduce the image quality.

7. Acquiring CEPH images

3. Click the **READY** button. The x-ray exposure has not started yet.
4. Now go to **7.3 X-ray Exposure** to begin operation.

7.3 X-ray Exposure

After alignment, the x-ray scan can begin.



The user must comply with the laws of the country regarding the usage of the medical equipment.



Direct the patient to close their eyes during operation.

To acquire optimized images, direct the patient to hold their breath and to not swallow. Also direct the patient to not move.

1. Direct the patient to close their eyes.
2. Close the door when leaving the x-ray room. Observe the patient during operation and check the imaging status.
3. Begin acquisition by pressing the exposure switch. Continue to press the exposure switch until the image has been acquired.

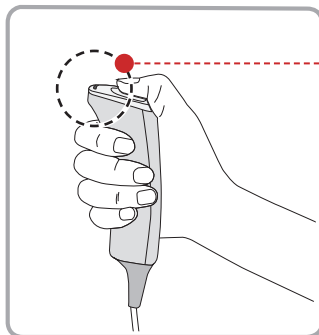

Orange: X-ray On

7. Acquiring CEPH images

During x-ray exposure, the status appears as follows.



- The exposure switch LED light is orange.
- The exposure switch LED light on top of the equipment is orange.
- An alert will sound to indicate that x-ray emission is currently underway.
- In the Console Software, the x-ray On in yellow changes.



7.4 Finishing Scan

1. Leave enough spaces between the ear rods.
2. Fold the nasal positioner up.
3. Guide the patient out of the equipment.

7.5 Confirming Image

Acquired images can be reconstructed and converted to DICOM format.

The exported images can be confirmed in EasyDent / EzDent-i.



Please refer to the EasyDent / EzDent-i User manual for more information.

1. The images are transferred to EasyDent / EzDent-i automatically.
2. The images are automatically saved if automatic save is configured in the basic settings. If automatic save is not configured in the basic settings, click the **Save to DB** button to save the images.
3. Double-click the image to confirm in the Patient list.

8

Acquiring CT Images

8.1	Setting Exposure Parameters	92
8.2	Patient Positioning	94
8.3	X-ray Exposure	100
8.4	Finishing Scan	101
8.5	Confirming Image	101

8. Acquiring CT Images

To acquire images, **5. Getting Started** should be completed first. If **5. Getting Started** is not completed, return to that section and finish the step first.

8.1 Setting Exposure Parameters

Perform the following procedures to select the capture parameters for the specific patient and capture mode. Please refer to **4.3 Console Software** for more information.

Steps for Configuring Imaging Conditions

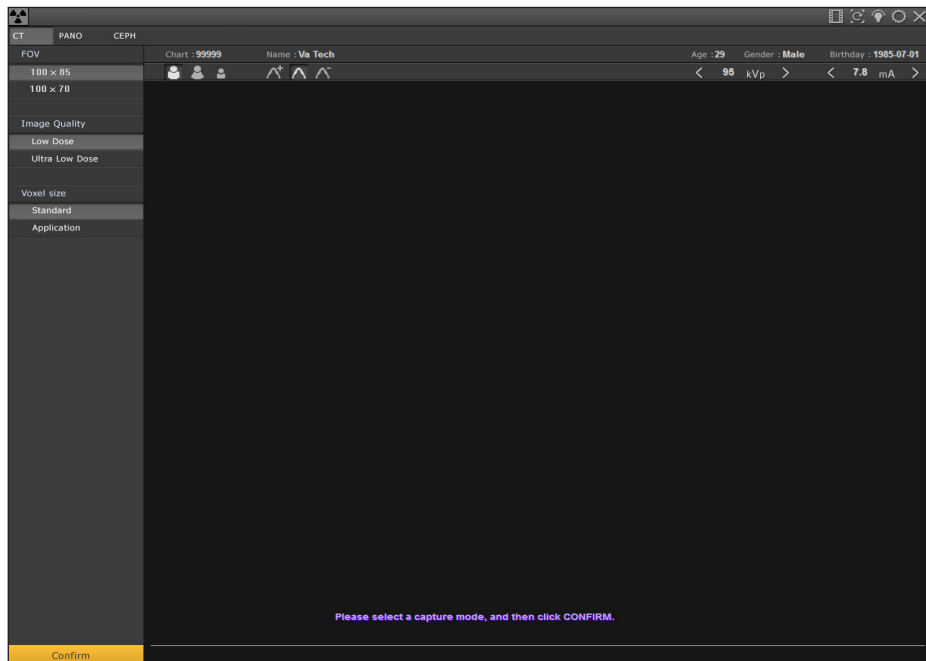

1. Select FOV Size. (Select 100 x 85 or 100 x 70)



100 x 85: for Adult, 100 x 70: for Child

2. Select Image Quality. (Select Low Dose or Ultra Low Dose)
3. Select Voxel Size. (Select Standard or Application)

8. Acquiring CT Images



MAR(Metal Artifact Reduction) is applied automatically if there are metal objects in the image. **MAR** may increase image reconstruction time.

4. The gender of the patient is selected automatically. When necessary, it can be selected directly.
5. Select x-ray intensity.



Hard, Normal, or Soft may be selected at the doctor's discretion.

Soft \leq Normal \leq Hard

6. The values of tube voltage and current are configured automatically according to the patient's gender and x-ray intensity. Click the arrow button to zoom in. The dose is adjustable by ± 1 kVp and ± 0.1 mA respectively.
7. Once the configuration has been completed, click the **Confirm** button.

When you click **Confirm** button:

- The **Ready** button is activated for X-ray exposure.



- The Rotating unit will move to its initial scanning position.
- Move the chin rest to a position suitable for the selected mode.
- The laser beam will be activated to make patient positioning easier.
- The **Scan Time** and **DAP** values will be shown on the Imaging Status Window.

DAP: 117.527565 mGy x Cm^2 Scan-Time: 13.5 Sec

8. Guide the patient to the equipment and position them.

8. Acquiring CT Images

8.2 Patient Positioning



- Have patients, especially pregnant women and children, wear a lead apron to protect them from residual radiation.
 - Be careful not to direct the laser beam into the patient's eyes. Doing so can result in a permanent loss of vision.
-



- Metal implants or bridges may reduce the quality of the images.
 - If the laser beam is not correctly positioned, distortion, where the image may be enlarged or reduced, or ghost shadows may occur and lower the image quality so please be careful.
-



Correct posture reduces the shadow cast by the patient's cervical spine and allows for clear image acquisition.



In general, images are acquired when the patient is standing. In special cases, a chair without a backrest (stool) may be used. Do not obstruct the laser beam or the operation of the equipment with the chair.

8. Acquiring CT Images

Getting prepared

1. Ask the patient to remove all the metal objects (glasses, earrings, hair pins, braces, false teeth). Metal objects may induce ghost images and lower the image quality.
2. Ask the patient to wear a lead apron to protect them from residual radiation.
3. **Use the Vertical Frame Up/Down button or switch option to adjust the equipment to match the height of the patient.**

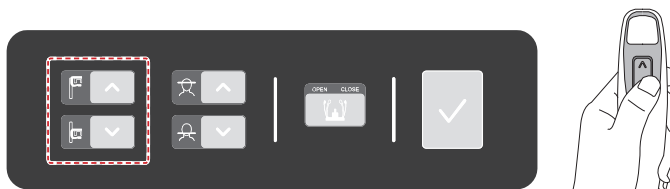

Patient Positioning

1. Insert the bite block into the chin rest then cover with a sanitary vinyl cover.

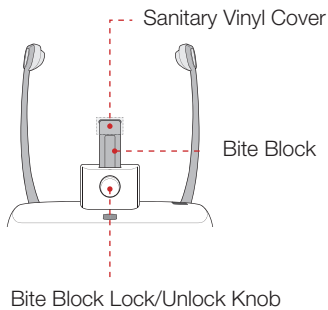

The sanitary vinyl cover is for single use only. It should be replaced after each patient.



Disinfect the chin rest and bite block with ethanol and wipe with a dry towel before the next patient.

8. Acquiring CT Images

2. Use **Temple Support Open/Close** button on the control panel to widen temple supports.



3. Guide the patient to the inside of the equipment.
4. Use the Vertical Frame Up/Down button or switch option to adjust the height of the equipment so the patient's chin reaches the chin rest.
5. Guide the patient to stand in the center of the equipment and direct them to remain in the position outlined below.
 - Two hands: Hold the handles of the equipment tightly.
 - Chest: Press against the equipment.
 - Two feet: Keep both feet close to the inside of the base.
 - Shoulders: Keep your shoulders relaxed and balanced.
 - Cervical Spine: Straighten your body and stand still.
6. Direct the patient to correctly bite into the bite block groove with their front teeth.
7. Turn the knob to fix the bite block in place.
8. Direct the patient to maintain the posture as described below.
 - Mouth: Close your mouth.
 - Tongue: Touch the roof of your mouth.
 - Two eyes: Close your eyes.

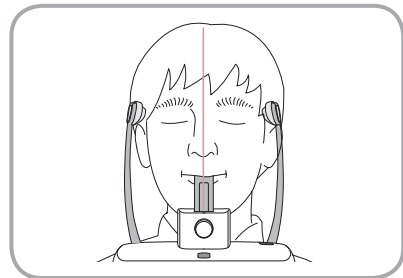

8. Acquiring CT Images

Correct posture reduces the shadow cast by the patient's cervical spine and allows for clear image acquisition. During image acquisition, direct the patient to maintain the posture as described below.



- Two hands: Hold the handles of the equipment tightly.
- Chest: Press against the equipment.
- Two feet: Keep both feet close to the inside of the base.
- Shoulders: Keep your shoulders relaxed and balanced.
- Cervical Spine: Straighten your body and stand still.
- Mouth: Bite the bite block and close your mouth.
- Tongue: Touch the roof of your mouth.
- Two eyes: Close your eyes.

Ask the patient to maintain their position and to not move until the image acquisition is completed.

8. Acquiring CT Images

■ Laser Beam Positioning



Be careful not to shine the laser beam directly into the person's eyes. Doing so may result in vision loss.



If the laser beam is not correctly positioned, distortion, where the image may be enlarged or reduced, or ghost shadows may occur and lower the image quality. Be sure to align the laser beam properly.

Mid-sagittal plane laser beam

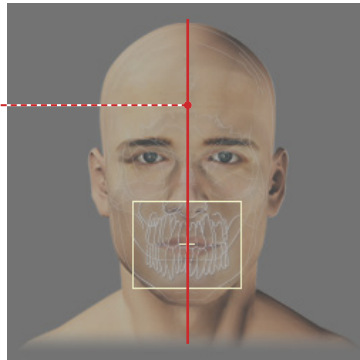

e.g. FOV 100 X 85



This is a sample illustration for reference only.
Actual FOV may vary from the image shown.

Align the Mid-sagittal plane laser beam with the center of the face. (To prevent horizontal expansion of the image)

8. Acquiring CT Images

■ Finishing Patient Positioning

1. After checking the positions of the patient and the laser beam, click the **Temple Support Open/Close** button on the control panel to prevent the patient's head from moving.



2. Click the **READY** button. The x-ray exposure has not started yet.
3. Now go to **8.3 X-ray Exposure** to begin operation.

8. Acquiring CT Images

8.3 X-ray Exposure

After alignment, the x-ray scan can begin.



The user must comply with the laws of the country regarding the usage of the medical equipment.



Direct the patient to close their eyes during operation.

To acquire optimized images, direct the patient to hold their breath and to not swallow. Also direct the patient to not move.

1. Direct the patient to close their eyes.
2. The user closes the door when leaving the X-ray room.
Observe the patient during operation and check the imaging status.
3. Begin acquisition by pressing the exposure switch.
Continue to press the exposure switch until the image has been acquired.

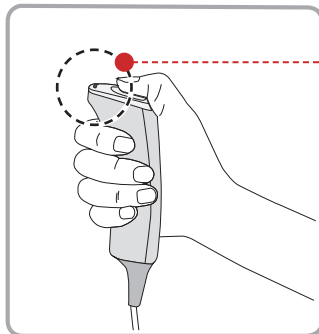

Orange: X-ray On

During x-ray exposure, the status appears as follows.

- The exposure switch LED light is orange.
- The exposure switch LED light on top of the equipment is orange.
- An alert will sound to indicate that x-ray emission is currently underway.
- In the console software, the x-ray On in yellow changes.



CT PANO CEPH

8. Acquiring CT Images

8.4 Finishing Scan

1. Open the temple supports and guide the patient out of the equipment.
2. Remove the sanitary vinyl cover from the bite block.
3. Press  (**Return**) button to bring the Rotating Unit back to its initial position.

8.5 Confirming Image

Acquired images can be reconstructed and converted to DICOM format.

The exported images can be confirmed in EasyDent / EzDent-i.



Please refer to the EasyDent / EzDent-i User manual for more information.

1. The images are transferred to EasyDent / EzDent-i automatically.
2. The images are automatically saved if automatic save is configured in the basic settings. If automatic save is not configured in the basic settings, click the **Save to DB** button to save the images.
3. Double-click the image to confirm in the Patient list.



9 | Troubleshooting

9. Troubleshooting

If a problem occurs while operating this equipment, perform the corresponding troubleshooting measure outlined in the table below. If the problem persists, please contact our customer support staffs.

If the device is not moving

Cause	Solution
Power failure	Check the equipment's power supply.
Initialization status	Wait until the equipment has initialized and then try again.
Control PC connection failure	Check the connection status of Communication Port(Optic) which connects the PC to the equipment.

If the exposure switch is not functioning

Cause	Solution
Ready status	Check whether it is ready for capturing at the console software.

If imaging cannot be performed

Cause	Solution
Initialization status	Wait until the equipment has initialized and then try again. If this problem persists, restart the equipment.

If the laser beam has shut off and patient alignment cannot be performed

9. Troubleshooting

Cause	Solution
The time allotted for patient alignment has expired	Press the laser beam button to turn on the lasers and then carry out patient alignment.



If a problem occurs during image acquisition, press the red emergency stop switch to immediately stop all moving parts and cut off all power to the equipment's electrical components. You may then safely release the patient from the equipment.



Do not allow any liquids in the vicinity of the machine as moisture may cause extensive damage to this equipment's electrical components.

10 | Cleaning and Maintenance

10.1 Cleaning.....	108
10.2 Maintenance	109

10. Cleaning and Maintenance



Always turn off the power to the equipment and disconnect it from the power outlet before cleaning.

10.1 Cleaning

- Thoroughly clean areas of the equipment which come into contact with the patient, such as the handle frame, chin support and bite block.
- Do not use spray cleaners or solvents as they could enter the equipment and damage to the electrical components or cause a fire.
- Do not use abrasive liquids such as acetone, gas, or oil, which could corrode the surface of the equipment.
- Do not use cleaning products which contain silicon as they could potentially damage the equipment's electrical components.

The following table summarizes the standard cleaning procedures to be performed by the operator.

Accessories	Cleaning Process
Bite Block	Disinfect with ethanol and gently wipe with a dry towel before the next patient.
Temple Supports	Disinfect with ethanol and gently wipe with a dry towel before the next patient.
Chin rest (Normal, Sinus, TMJ)	Disinfect with ethanol and gently wipe with a dry towel before the next patient.
All components that come into contact with the patient or operator	Clean components using an alcohol-based disinfectant before each patient is X-rayed.
Computer and peripherals	Follow the manufacturers' instructions found in the accompanying manuals.
Outer covers of equipment	Wipe the unit with a dry cloth at the end of each day.



Do not use cleaning agents in aerosol or spray form directly on the surface of the equipment.

10. Cleaning and Maintenance

10.2 Maintenance

VATECH requires periodic constancy tests to ensure image quality and the safety for the patient and operator.

Only VATECH authorized technicians can perform inspection and service of this equipment. For the technical assistance, contact VATECH service center or your local VATECH representative.

10.2.1 Regular Maintenance



- Always turn off the equipment before performing any maintenance.
 - Never remove equipment covers. There are no repairable parts inside.
 - The only part that can be replaced by the user is the input fuses, which must comply with the manufacturer's specification.
 - In order to safeguard against fire, only replace fuses with fuses of the same type and range.
-



- There are no user serviceable parts inside this equipment.
 - If servicing is required, please contact the VATECH service center or your local VATECH representative.
-

- Do not use force to unplug cables.
- Do not expose the equipment or components in an area which is susceptible to water or humidity.
- Do not expose the equipment in an area which subject to temperature extremes, poor ventilation, direct sun light, dust, salt, etc.
- Keep all detachable components well organized and clean.
- Make sure that the equipment is well grounded.
- Never try to modify this equipment, including the wires or cables. Modifying this equipment may damage it beyond repair.

10. Cleaning and Maintenance

10.2.2 Maintenance Task Checklis

Maintenance Tasks	Maintenance period
Before operation, ensure that the equipment is clean and ready for use. Make sure that all parts which come into contact with the patient have been disinfected and cleaned.	Daily
After using the equipment, make sure that the main power switch has been turned off.	Daily
Ensure that the equipment is firmly plugged into a dedicated power source.	Daily
Ensure that the plug and power cord are not hot.	Daily
Confirm that the orange (exposure) indicator lamp turns on when the exposure switch is pressed. Ensure that the orange (exposure) indicator light remains on for the entire duration of the exposure.	Daily
Ensure that the power cable is not kinked, broken, exposed and that it is free of all other defects.	Daily
Confirm that activating the emergency stop switch ceases the unit's operation. Pressing the emergency stop switch should stop all equipment movements and X-ray emission.	Weekly
Ensure that all visible labels are intact and legible.	Weekly
Check for possible wear or damage to the exposure switch cable.	Monthly
Confirm that the audio message is audible throughout the duration of the exposure.	Monthly



Please refer to the “Constancy Test Requirement” for documents about the image quality inspection methods.



11 | Disposing of the Unit

11. Disposing of the Unit

In order to reduce environmental contamination, this equipment is designed to be as safe as possible to use and dispose of. Many components of this equipment, except for some like X-ray tube, are environment-friendly and can be recycled.

All parts and components which contain hazardous materials must be disposed in accordance with disposal regulations (IEC 60601-1 6.8.2 j).

Part	Material	Recyclable	Waste Disposal Site	Hazardous waste; Needs Separate Collection
Frame and covers	Aluminum and plastics	•		
Motors		•		
Circuit boards		•		
Cables and transformer	Copper	•		
	Steel	•		
	Oil		•	
Packing	Wood	•		
	Cardboard	•		
	Paper	•		
X-ray tube				•
Sensor head	Return the sensor head to VATECH			
Other parts			•	



This dental equipment shall not be disposed of as domestic garbage materials.



Please clean, disinfect and sterilize the equipment before disassembling it and disposing of its parts.



Please observe all regulations relevant to the disposal of waste in your country.

12 | Technical Specifications

12.1 Mechanical Specifications	114
12.2 Technical Specifications	119
12.3 Electrical Specifications	123
12.4 Environmental Specifications	123

12. Technical Specifications

12.1 Mechanical Specifications

■ Image Magnification

Mode	FDD (mm)	FOD (mm)	ODD (mm)	Magnification
CT	600	428.57	171.43	1.4 CONSTANT
PANO	600	428.57	171.43	1.4 CONSTANT
CEPH	1745	1524	221	1.14 CONSTANT

- **FDD:** Focal Spot to Detector Distance
- **FOD:** Focal Spot to Object Distance
- **ODD:** Object to Detector Distance ($ODD = FDD - FOD$)
- **Magnification** = FDD / FOD

Dimension

■ PANO/CT

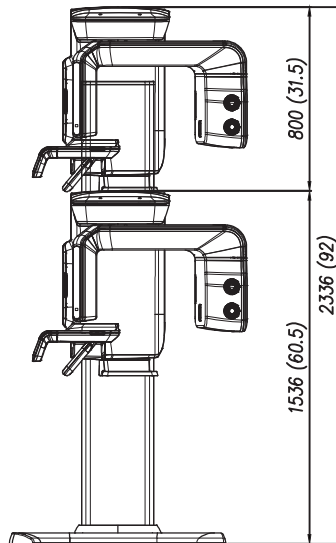
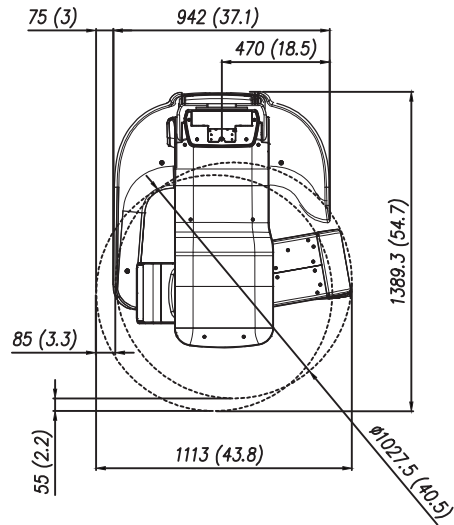

[Unit : mm]

12. Technical Specifications

■ PANO/CT/CEPH

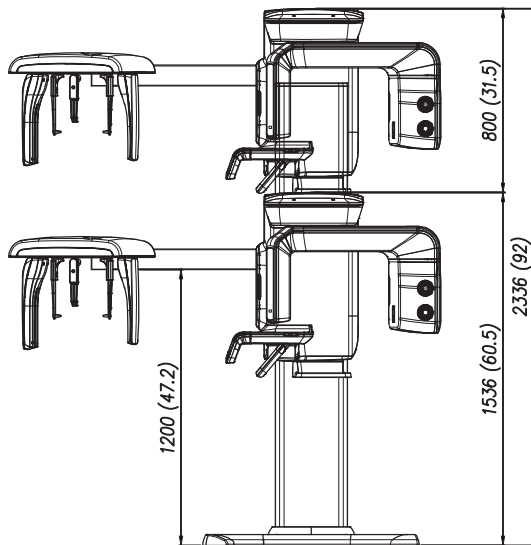
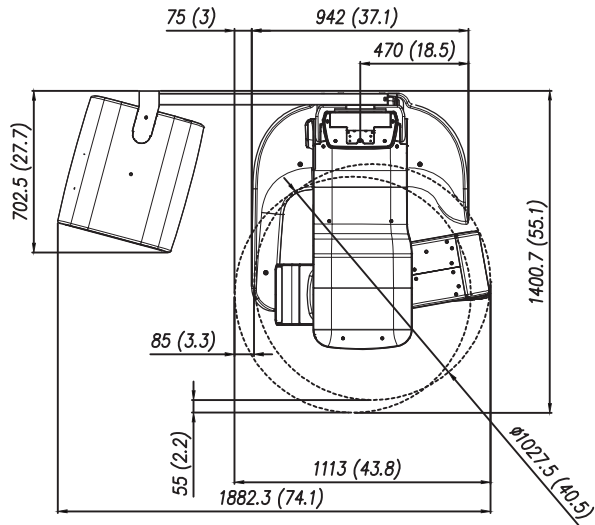

[Unit : mm]

12. Technical Specifications

■ PANO/CT/CEPH (OneShot type)

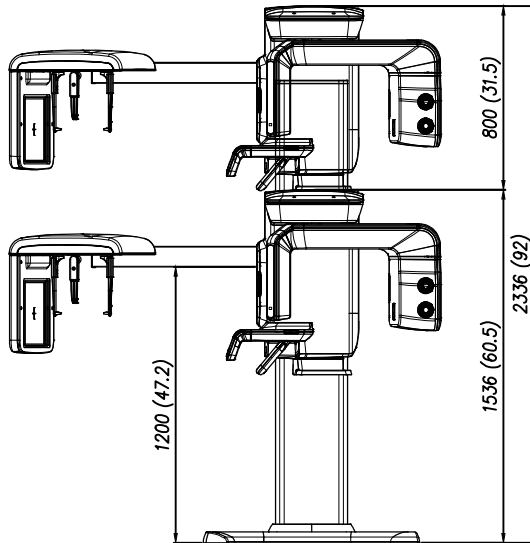
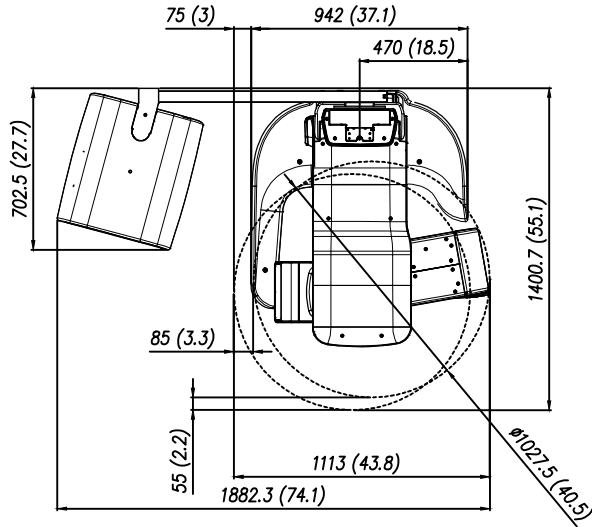

[Unit : mm]

12. Technical Specifications

Item	Description		
Weight	without CEPH unit	Without Base	167 kg (368.2 lbs)
		with Base	220 kg (485 lbs)
	with CEPH unit (scan type)	Without Base	202 kg (445.3 lbs)
		with Base	255 kg (562.2 lbs)
Total Height		Max. 2336 mm (92 inch)	
Vertical Column Movement		Max. 700 mm (Max. 27.6 inch)	
Dimension (Length x Width x Height)	without CEPH unit	1113 (L) x 1389(W) x 2336 (H) mm	
		43.8(L) x 54.7(W) x 92(H) inch	
	with CEPH unit (scan type)	1882 (L) x 1400 (W) x 2336 (H) mm	
74.1(L) x 55.1(W) x 92(H) inch			
with CEPH unit (oneshot type)	1882 (L) x 1400 (W) x 2336 (H) mm		
74.1(L) x 55.1(W) x 92(H) inch			
Type of installation		Base stand / Wall mount	

12.2 Technical Specifications

X-Ray Generator

Item	Description	
Model	DG-07C11T2	
Rated output power	1.6KW (1sec)	
High Voltage Generator	Type	Inverter Type
	Normal / Pulse	50 ~ 99 kV (Max. 99kV 10mA)
		4 ~ 16 mA (Max 75kV 16mA)
		0.5 ~ 20 sec
	Cooling	Automatically controlled / Protect $\geq 60^{\circ}\text{C}$ Cooling Fan : Optional
	Added Filtration (mmAl)	2.0 mm Al eq.
Total Filtration (mmAl)	2.8 mm Al eq.	
X-ray tube	Model Name	D-052SB(Stationary Anode Type)
	Manufacturer	Toshiba
	Focal Spot (mm)	0.5 mm Nominal (IEC60336)
	Inherent Filtration (mmAl)	At least 0.8 mm Al eq. at 50 kV
	Target angle	5 °
	X- ray Coverage	95 x 380 mm at SID 550 mm
	Anode Heat Content	35 kJ
Duty Cycle	1:60 or more (Exposure time : Interval time)	
Weight	INV-11 Inverter	1.35 kg
	DG-07CT2(H-Type) Monotank	12.5 kg

12. Technical Specifications

S/N	XXXX	XXX	XX	X.XX	XX	XX	XXXX
	Size (mm)			(X.X or X)			
	Model	Tube	Inverter ver.	F/W ver.	Weekly code	Yearly code	Serial

D-052SB

Maximum Rating Charts

DC (Center Grounded)

Constant potential high-voltage generator

Nominal Focus Spot Value: 0.5

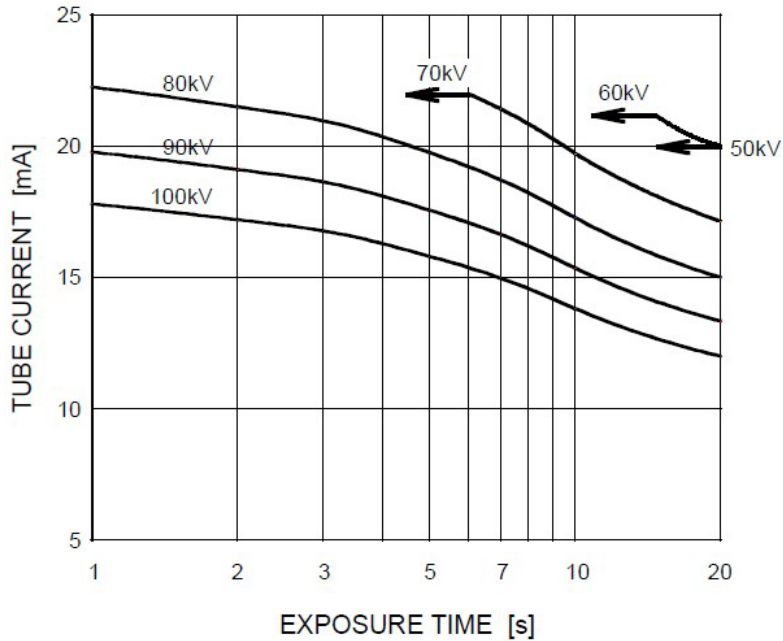

Emission & Filament Characteristics

Constant potential high-voltage generator
Nominal Focus Spot Value: 0.5

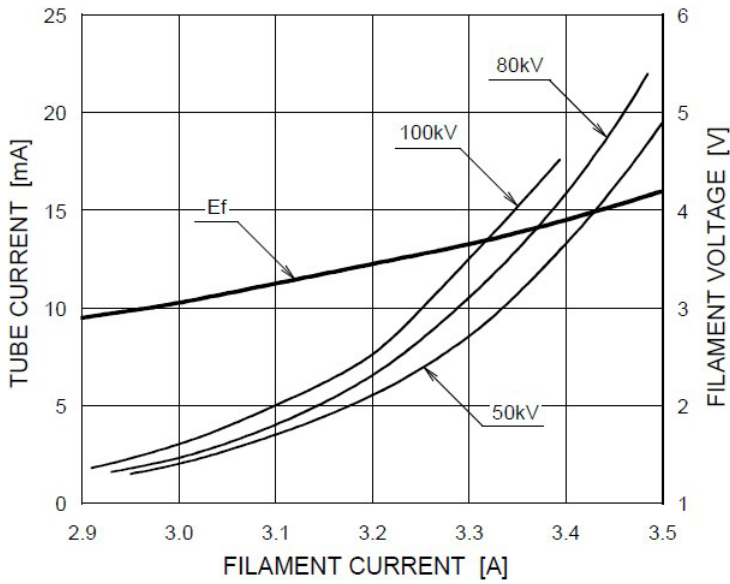

Anode Thermal Characteristics

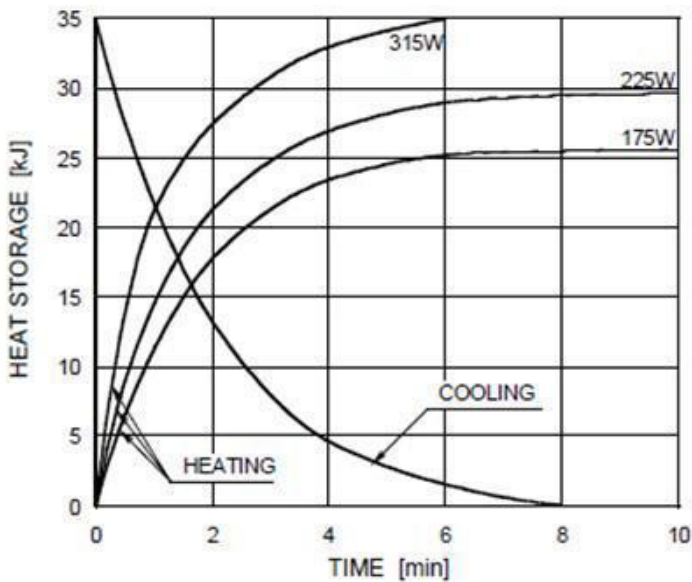

12. Technical Specifications

Detector Specifications

Item (PANO / CT)	Description		
Model	Xmaru1404CF		
Detector type	CMOS Photodiode Array		
Pixel size (μm)	49.5 99 (2x2 Binning) 198 (4x4 Binning)		
Active area (mm)	135.8 x 36.4		
Frame rate (FPS)	53.5 107(2x2 Binning) 308(4x4 Binning)		
A/D (bits)	14		
Sensor size (mm)	230 x 160 x 26		
Item (CEPH)	Description		
Model	Xmaru2301CF	1210SGA	910SGA
Detector type	CMOS Photodiode Array	Amorphous Silicon TFT with Scintillator	
Pixel size (μm)	100	127	
Active area (mm)	5.9 x 230.4	264 x 352	222 x 254
Frame rate (FPS)	200	240	
A/D (bits)	14		
Sensor size (mm)	251.2 x 69 x 27.1	402 x 364 x 32	314 x 279 x 24

12. Technical Specifications

12.3 Electrical Specifications

Item	Description
Power supply voltage	AC 100-240 V \pm 10 %
Frequency	50/60 Hz
Power rating	2.2 kVA \pm 10 %

- The input line voltage depends on the local electrical distribution system.
- Allowable input voltage fluctuation requirement: \pm 10 %.

12.4 Environmental Specifications

	Item	Description
During operating	Temperature	10 ~ 35 °C
	Relative humidity	30 ~ 75 %
	Atmospheric pressure	860 ~ 1060 hPa
Transport and storage	Temperature	-10 ~ 60 °C
	Relative humidity	10 ~ 75 %
	Atmospheric pressure	860 ~ 1060 hPa

13 | Appendices

13.1 Recommended X-ray Exposure Table	126
13.2 X-ray Dose Data	128
13.3 Electromagnetic Compatibility (EMC) Information	132
13.4 Abbreviations	135

13. Appendices

13.1 Recommended X-ray Exposure Table

A. PANO

Standard / TMJ / Sinus / CARPUS

Gender / Figure	Hard (kVp / mA)	Normal (kVp / mA)	Soft (kVp / mA)
Man	75 / 12	74 / 12	73 / 12
Woman	74 / 12	73 / 12	72 / 12
Child	68 / 10	67 / 10	66 / 10

[Fast Mode]

Gender / Figure	Hard (kVp / mA)	Normal (kVp / mA)	Soft (kVp / mA)
Man	75 / 14	74 / 14	73 / 14
Woman	74 / 14	73 / 14	72 / 14
Child	68 / 12	67 / 12	66 / 12

* Tube voltage and current variation range in the PANORAMIC mode (recommended): 50 ~ 80 kVp, 4 ~ 14 mA

B. CEPH (Scan)

Lateral

Gender \ Figure	Hard (kVp / mA)	Normal (kVp / mA)	Soft (kVp / mA)
Man	87/10	85/10	83/10
Woman	85/10	83/10	81/10
Child	82/10	80/10	78/10

PA / SMV / Waters View

Gender \ Figure	Hard (kVp / mA)	Normal (kVp / mA)	Soft (kVp / mA)
Man	90/10	88/10	86/10
Woman	88/10	86/10	84/10
Child	85/10	83/10	80/10

CARPUS

Gender \ Figure	Hard (kVp / mA)	Normal (kVp / mA)	Soft (kVp / mA)
Man	60/6	60/5	60/4
Woman	60/6	60/5	60/4
Child	60/6	60/5	60/4

* Tube voltage and current variation range in the CEPHALOMETRIC mode (recommended)
: 60 ~ 90 kVp, 4 ~ 12 mA

C. CBCT

Mode		Low Dose		Ultra Low Dose	
		kVp	mA	kVp	mA
Man	Hard	95	6.6	70	6.3
	Normal	94	6.6	69	6.3
	Soft	93	6.6	68	6.3
Woman	Hard	95	6.3	70	6.0
	Normal	94	6.3	69	6.0
	Soft	93	6.3	68	6.0
Child	Hard	95	6.3	70	6.0
	Normal	94	6.3	69	6.0
	Soft	93	6.3	68	6.0



X-ray intensity (**Hard**, **Normal**, **Soft**) is according to the operator's decision.

Soft ≤ Normal ≤ Hard



- Maximally allowed tube voltage / current: kVp ± 10 % / mA ± 20 % according to IEC60601-2-7.
- Due to image optimization performed prior to shipping, equipment data may differ slightly from those specified in the table.

13. Appendices

13.2 X-ray Dose Data

The X-ray dose data is extracted from the X-ray Dose Test Report for the PaX-i3D Smart.

X-ray Dose Test Report for the PaX-i3D Smart maintains dosimetric evaluation of VATECH dental diagnostic system meets all requirements specified in the IEC Collateral Standard. To limit unnecessary exposure to the patient, operator or other staff, the PaX-i3D Smart is designed to comply with IEC 60601-1-3 Part 1 General Requirements for Safety.

Test Condition	
Brand Name (Model)	PaX-i3D Smart(PHT-30LFO)
Sensor type	PANO/CT: Xmaru 1404CF CEPH: Xmaru 2301CF(Scan Type)
X-ray generator	DG-07C11T2

2.1 DAP Table

Test Equipment			
Instrument	Manufacturer	Model	S/N
Dose Meter	Piranha	205	CB2-06100053

Mode Tested: PANO HD Normal Adult 13.6s						
kVp \ mA	6		8		10	
	[mGy]	[mGy · cm ²]	[mGy]	[mGy · cm ²]	[mGy]	[mGy · cm ²]
60	6.25	40.50	9.33	59.71	1260	81.65
70	9.29	60.20	12.37	79.17	15.64	98.75
80	12.57	81.45	15.65	100.16	18.92	122.60
90	15.33	99.34	18.41	117.82	21.68	140.49

13. Appendices

Mode Tested: CEPH PA & LAT, 12.9s						
kVp \ mA	6		8		10	
	[mGy]	[mGy · cm ²]	[mGy]	[mGy · cm ²]	[mGy]	[mGy · cm ²]
60	0.39	4.7	0.50	6.1	0.63	7.6
70	0.53	6.4	0.71	8.6	0.88	10.6
80	0.69	8.4	0.92	11.1	1.15	13.9
90	0.86	10.4	1.15	13.9	1.45	17.5

Mode Tested: CT (FOV 100x85), Low Dose 18s						
kVp \ mA	6		8		10	
	[mGy]	[mGy · cm ²]	[mGy]	[mGy · cm ²]	[mGy]	[mGy · cm ²]
60	3.16	157.75	4.18	209.20	5.12	255.95
70	4.58	229.05	6.12	305.80	7.65	382.55
80	6.33	316.55	8.38	418.95	10.47	523.65
90	8.16	409.45	10.88	543.90	13.54	676.95

2.2 X-ray Scatter Dose

Test Equipment Information			
Instrument	Manufacturer	Model	S/N
Radiation Monitor Controller	Radcal	9015	91-1470/19069

PANO Mode

Mode Tested: PANO HD Normal Adult 13.6s	
Mode Tested	PANO HD
Applied Tube Voltage Peak [kVp]	80
Applied Tube Current [mA]	14

Direction [°]	Mode	PANO UHD 16.6 s [mR/hr]		
		1 m (3.3 ft)	1.5 m (4.9 ft)	2 m (6.6 ft)
0		60.9	17.7	8
45		19.6	12.4	5.8
90		10.6	6.8	4.1
135		22.1	12.5	5.6
180		1	0	0
225		45.4	21.4	9.4
270		47.6	21.9	9.2
315		76.4	19.4	8.6

CT Mode

Test Condition	
Tested Mode	CT FOV 100 x 85 18s Low Dose
Applied Tube Voltage Peak [kVp]	99
Applied Tube Current [mA]	14

Direction [°]	Mode	Ultra Low Dose, FOV 100 x 80 5.9s [mR/hr]		
		1 m (3.3 ft)	1.5 m (4.9 ft)	2 m (6.6 ft)
0		588.2	135.3	87.1
45		549.3	249.4	106.8
90		472.6	307.3	78.4
135		458.8	287.6	89.3
180		12.9	4.6	1.3
225		410.5	288.7	98.2
270		663.2	301.4	112.4
315		429.7	194.2	92.3

13.3 Electromagnetic Compatibility (EMC) Information

Guidance and manufacturer's declaration - electromagnetic emissions.

The model PaX-i3D Smart(PHT-30LFO) is intended for use in the electromagnetic environment specified below. The customer or the user of the model PaX-i3D Smart(PHT-30LFO) should assure that it is used in such an environment.

Emissions test	Compliance	Electromagnetic environment - guidance
RF emissions CISPR 11	Group 1	The model PaX-i3D Smart(PHT-30LFO) uses RF energy only for its internal function. Therefore, its RF emissions are very low and are not likely to cause any interference in nearby electronic equipment.
RF emissions CISPR 11	Class A (The model PaX-i3D Smart(PHT-30LFO) in combination with the shielded location)	The model PaX-i3D Smart(PHT-30LFO) must be used only in a shielded location with a minimum RF shielding effectiveness and, for each cable that exits the shielded location, a minimum RF filter attenuation of 20 dB from 30 MHz to 230 MHz, 20 dB from 230 MHz to 1 GHz. The model PaX-i3D Smart(PHT-30LFO) , when installed in such a shielded location, is
Harmonic emissions IEC 61000-3-2	Not applicable	suitable for use in all establishments other than domestic, and may be used in domestic establishments and those directly connected to the public low-voltage power supply network that supplies buildings used for domestic purposes.
Voltage fluctuations / flicker emissions IEC 61000-3-3	Not applicable	

(NOTE) It is essential that the actual RF shielding effectiveness and filter attenuation of the shielded location be verified to ensure that they meet or exceed the specified minimum values.

13. Appendices

Guidance and manufacturer's declaration - electromagnetic immunity

The model PaX-i3D Smart(PHT-30LFO) is intended for use in the electromagnetic environment specified below. The customer or the user of the model PaX-i3D Smart(PHT-30LFO) should assure that it is used in such an environment.

Emissions test	Compliance	Compliance level	Electromagnetic environment -guidance
Electrostatic discharge (ESD) IEC 61000-4-2	± 6 kV Contact ± 8 kV air	± 6 kV Contact ± 8 kV air	Floors should be wood, concrete or ceramic tile. If floors are covered with synthetic material, the relative humidity should be at least 30 %.
Electrical fast transient/burst IEC 61000-4-4	± 2 kV for power supply lines ± 1 kV for input/output lines	± 2 kV for power supply lines ± 1 kV for input/output lines	Mains power quality should be that of a typical commercial or hospital environment.
Surge IEC 61000-4-5	± 1 kV line(s) to line(s) ± 2 kV line(s) to earth	± 1 kV line(s) to line(s) ± 2 kV line(s) to earth	Mains power quality should be that of a typical commercial or hospital environment.
Voltage dips, short interruptions and voltage variations on power supply input lines IEC 61000-4-11	< 5 % Ut (> 95 % dip in Ut) for 0.5cycle 40 % Ut (60 % dip in Ut) for 5 cycle, 6 cycle 70 % Ut (30 % dip in Ut) for 25 cycle, 30 cycle <5 % Ut (< 95 % dip in Ut) for 5 s	< 5 % Ut (> 95 % dip in Ut) for 0.5cycle 40 % Ut (60 % dip in Ut) for 5 cycle, 6 cycle 70 % Ut (30 % dip in Ut) for 25 cycle, 30 cycle <5 % Ut (< 95 % dip in Ut) for 5 s	Mains power quality should be that of a typical commercial or hospital environment. If the user of the model PaX-i3D Smart(PHT-30LFO) image intensifier requires continued operation during power mains interruptions, it is recommended that the model PaX-i3D Smart(PHT-30LFO) be powered from an uninterruptible power supply.
Power frequency (50/60 Hz) magnetic field IEC 61000-4-8	3 A/m	3 A/m	Power frequency magnetic fields should be at levels characteristic of a typical location in a typical commercial or hospital environment.

NOTE) Ut is the a.c. mains voltage prior to application of the test level.

13. Appendices

Guidance and manufacturer's declaration - electromagnetic immunity

The model PaX-i3D Smart(PHT-30LFO) is intended for use in the electromagnetic environment specified below. The customer or the user of the model PaX-i3D Smart(PHT-30LFO) should assure that it is used in such an electromagnetic environment

Immunity test	IEC 60601 test level	Compliance level	Electromagnetic environment - guidance
Conducted RF IEC 61000-4-6 Radiated RF IEC 61000-4-3	3 Vrms 150 kHz to 80MHz 3 V / m 80 MHz to 2.5GHz	3 Vrms 150 kHz to 80 MHz 3 V / m 80 MHz to 2.5 GHz	The model PaX-i3D Smart(PHT-30LFO) must be used only in a shielded location with a minimum RF shielding effectiveness and, for each cable that exits the shielded location, a minimum RF filter attenuation of 20 dB from 30 MHz to 230 MHz, 20 dB from 230 MHz to 1 GHz. Field strengths outside the shielded location from fixed RF transmitters, as determined by an electromagnetic site survey, should be less than 3 V / m.a Interference may occur in the vicinity of equipment marked with the following symbol:

NOTE 1) These guidelines may not apply in all situations. Electromagnetic propagation is affected by absorption and reflection from structures, objects and people.

NOTE 2) It is essential that the actual shielding effectiveness and filter attenuation of the shielded location be verified to assure that they meet the minimum specification.

a Field strengths from fixed transmitters, such as base stations for radio (cellular/cordless) telephones and land mobile radios, amateur radio, AM and FM radio broadcast and TV broadcast cannot be predicted theoretically with accuracy. To assess the electromagnetic environment due to fixed RF transmitters, an electromagnetic site survey should be considered. If the measured field strength outside the shielded location in which the model PaX-i3D Smart(PHT-30LFO) is used exceeds 3V/m, the model PaX-i3D Ortho (TON-95LH) should be observed to verify normal operation. If abnormal performance is observed, additional measures may be necessary, such as relocating the model PaX-i3D Smart(PHT-30LFO) or using a shielded location with a higher RF shielding effectiveness and filter attenuation.

13.4 Abbreviations

AC	Alternating Current
AF	Auto-Focusing
AMPT	Adaptive layer Mode Panoramic Tomography
CAN	Controlled Area Network
CBCT	Cone-Beam Computed Tomography
CMOS	Complementary Metal-Oxide -Semiconductor
CT	Computed Tomography
DAP	Dose Area Product
DC	Direct Current
DICOM	Digital Imaging and Communications in Medicine
EMC	Electromagnetic Compatibility
ENT	Ear, Nose and Throat
ESD	ElectroStatic Discharge
EUT	Equipment Under Test
FDD	Focal spot to Detector Distance
FOD	Focal spot to Object Distance
FOV	Field of View
FPD	Flat Panel Detector
IEC	International Electro technical Commission
ISO	International Standards Organization
LCD	Liquid Crystal Display
LED	Light-Emitting Diode
MAR	Metal Artifact Reduction
MPSO	Multiple Portable Socket-Outlet
ODD	Object to Detector Distance
PA	Posterior / Anterior
RF	Radio Frequency
ROI	Region of Interest

13. Appendices

SID	Source to Image receptor Distance
SIP	Signal Input Part
SOP	Signal Output Part
SMV	Submento-Vertical
TMJ	Temporomandibular Joint
UHD	Ultra High Definition

13. Appendices

Copyright by © 2014 VATECH

All rights reserved.

The documentation, brand name and logo used in this manual are copyrighted.

No part of this manual may be reproduced, transmitted, or transcribed without the expressed written permission of the manufacturer.

We reserve the right to make any alterations which may be required due to technical improvement. For the most current information, contact your VATECH representative.

Tel: +82-1588-9510

Email: gcs@vatech.co.kr

Website: www.vatech.co.kr

Headquarters: 13, Samsung 1-ro 2-gil, Hwaseong-si, Gyeonggi-do, Korea

Factory: 13, Samsung 1-ro 2-gil, Hwaseong-si, Gyeonggi-do, Korea



The CE symbol grants this product compliance to the European Directive for Medical Devices 93/42/EEC as amended by 2007/47/EC as a class II b device.



EC Representative; Vatech Dental Manufacturing Ltd.

Axiom House, The Centre, Feltham, Middlesex TW13 4AU UK

Tel: +44-0208-831-1660

Fax: +44-0208-831-1679
