

PaX-i Insight™ PaX-i Plus™

User Manual

Model : PCH-30CS
Version : 1.39

-
- English



Full version

Notice

Thank you for purchasing the **PaX-i Plus / PaX-i Insight (Model: PCH-30CS)** extra-oral imaging system.

PCH-30CS is an advanced digital diagnostic system that incorporates PANO and CEPH (Optional) imaging capabilities into a single system. **PCH-30CS** is classified into two types – **PaX-i Plus** and **PaX-i Insight** - according to the availability of Insight PAN function.

<i>Module</i>	<i>Option details</i>
<i>PaX-i Plus NP</i>	<i>PANO only</i>
<i>PaX-i Insight NP</i>	<i>PANO only</i>
<i>PaX-i Plus NC</i>	<i>PANO + CEPH</i>
<i>PaX-i Insight NC</i>	<i>PANO + CEPH</i>

This manual describes how to operate the **PCH-30CS** system and covers differences in the specifications between **PaX-i Plus** and **PaX-i Insight**. It is recommended that you thoroughly familiarize yourself with this manual to make the most effective use of this equipment.

Observe all cautions, safety messages, and warnings that appear in this manual.

Due to constant technological improvement, the manual may not contain the most updated information and is subject to change without prior notice to the persons concerned. For further information not covered in this manual, please contact us at:

VATECH Co., Ltd.

Phone: +82-1588-9510

E-mail: gcs@vatech.co.kr

This document is originally written in English.

PCH-30CS is referred to as “equipment” in this manual.

Manual Name: PaX-i Plus / PaX-i Insight (Model: PCH-30CS) User Manual

Document Name: VDH-UM-070

Version: 1.39

Publication Date: 2021-09

This page intentionally left blank

Table of Contents

Notice	v
Table of Contents	vii
1. Introduction	1
1.1 Overview	1
1.2 Indications for Use	1
1.3 Intended Purposes	1
1.4 Contraindications	1
1.5 Intended User Profiles.....	2
2. General Information	3
2.1 Manufacturer's Liability.....	3
2.2 Owner and Operator's Obligations	3
2.3 Conventions in this Manual	4
2.4 Marks and Symbols.....	5
3. Warnings and Precautions	9
3.1 General Safety Guidelines	9
3.2 Electricity-related Safety Precautions	13
3.3 Radiation Safety	15
3.4 Warnings	16
4. Imaging System Overview	19
4.1 System Components.....	19
4.2 Features.....	19
4.3 Standards and Regulations.....	20
4.4 Operating Principles	21
4.5 Imaging System Configuration.....	22
4.6 Equipment Overview	24
5. Imaging Software Overview	29
5.1 EzDent-i / EasyDent	31
5.2 Console Software.....	32

6.	Getting Started	37
6.1	Turning on the Equipment.....	37
6.2	Running the Image Viewer (EzDent-i / EasyDent)	38
6.3	Initiating the Console Software	43
7.	Acquiring PANO Images	45
7.1	PANO Imaging Program Overview	45
7.2	Configuring Exposure Parameters	49
7.3	Patient Positioning.....	54
7.4	X-ray Exposure.....	70
7.5	Finishing the Scan	71
7.6	Checking the Captured Images.....	71
8.	Acquiring CEPH Images (Optional)	72
8.1	CEPH Imaging Program Overview.....	72
8.2	Configuring Exposure Parameters	74
8.3	Patient Positioning.....	77
8.4	X-ray Exposure.....	87
8.5	Finishing the Scan	88
8.6	Checking the Captured Images.....	88
9.	Troubleshooting	90
9.1	Troubleshooting	90
9.2	Error Codes.....	91
10.	Cleaning and Disinfection	108
10.1	Cleaning	109
10.2	Disinfection	110
11.	Maintenance	112
11.1	Regular Maintenance	112
11.2	Maintenance Task Checklist.....	113
12.	Disposing of the Equipment	114
13.	Technical Specifications	116

13.1	Mechanical Specifications.....	116
13.2	Technical Specifications	119
13.3	Electrical Specifications.....	126
13.4	Environmental Specifications	127
14.	Appendices	129
14.1	Recommended X-ray Exposure Tables	129
14.2	X-ray Dose Data.....	136
14.3	Electromagnetic Compatibility (EMC) Information	149
14.4	Hand-wrist Image Evaluation References	152
14.5	Acquiring Images for Pediatric Dental Patients	156
14.6	Abbreviations	166

1. Introduction

1.1 Overview

PaX-i Plus / PaX-i Insight (Model: PCH-30CS) is an advanced 2-in-1 digital X-ray imaging system that incorporates PANO and CEPH (Optional) imaging capabilities into a single system and acquires 2D diagnostic image data in conventional panoramic and cephalometric modes.

1.2 Indications for Use

PaX-i Plus / PaX-i Insight (Model: PCH-30CS) is intended to produce panoramic or cephalometric digital x-ray images. It provides diagnostic details of the dento-maxillofacial, sinus, and TMJ for adult and pediatric patients. The system also utilizes carpal images for orthodontic treatment. The equipment is to be operated by physicians, dentists, and x-ray technicians.

1.3 Intended Purposes

- Determination of the extent of lesions, tumors, cysts, etc., which cannot be fully visualized on plain films
- Diagnosis of foreign bodies or displaced roots involving the maxillary sinus
- Diagnosis of bone diseases, cysts, etc., affecting the temporomandibular joints
- Identifying the relationship of the inferior dental canal to a tooth/lesion that is to be removed
- Diagnosis of un-erupted teeth impacted teeth and odontomas
- Diagnosis of root resorption of teeth
- Diagnosis of CRS (Chronic Rhinosinusitis)
- Assessment of fractures on maxilla, mandible, condylar neck, and fractures of teeth where plain film imaging is equivocal
- Detailed verification of images in-depth direction (**PaX-i Insight only**)

1.4 Contraindications

There are no known contraindications to use of this equipment.

1.5 Intended User Profiles

Considerations	Requirement Description
Education	<ul style="list-style-type: none"> Licensed dentists or dental hygienists, radiologists, and graduates of relevant bachelor's degrees (national qualifications)
Knowledge	<ul style="list-style-type: none"> Understanding of the treatment and diagnosis of dental disease Understanding the terms and guidance of hardware and software of diagnostic medical radiation equipment and recognizing equipment connection, installation, operating conditions
Language understanding	<ul style="list-style-type: none"> Understanding how to use manuals (English / Korean) Or Understanding other languages provided
Experience	<ul style="list-style-type: none"> Understanding the objectives and effects of the diagnosis and treatment of dental disease using diagnostic medical radiation equipment Understanding of the normal operation of diagnostic medical radiation equipment Understanding of the contents of the User Manual

IMPORTANT

The dental X-ray equipment should be used by qualified personnel (dentists, dental hygienists, radiologists) only.

2. General Information

2.1 Manufacturer's Liability

The manufacturers and/or retailers of this X-ray equipment assume responsibility for the safe and normal operation of this product only when:

- The equipment has been installed by a **VATECH**-authorized technician.
- The equipment has been installed by all the cautions and conditions required for installation.
- The genuine **VATECH** approved equipment and components have been used always.
- All maintenance and repairs have been performed by a **VATECH**-authorized agent.
- The equipment has been used normally by the **User Manual**.
- The equipment damage or malfunction is not the result of an error on the part of the owner or the operator.







2.2 Owner and Operator's Obligations

- The owner of this equipment shall perform constancy tests at regular intervals to ensure patient and operator safety. These tests must be performed by local X-ray safety regulations.
- The owner of this equipment shall perform regular inspection and maintenance of the mechanical and electrical components in this equipment to ensure safe and consistent operation (IEC 60601-1).
- The owner of this equipment shall ensure inspection and cleaning work is performed by the maintenance schedule outlined in **Chapter 10. Cleaning and Disinfection**.













2.3 Conventions in this Manual

The following symbols are used throughout this manual. Make sure that you fully understand each symbol and follow the instructions accompanied.







To prevent physical injury and/or damage to the equipment, please observe all warnings and safety information included in this document.

	WARNING	This indicates information that should be followed with the utmost care. Failure to comply with a warning may result in severe damage to the equipment or physical injury to the operator and/or patient.
	CAUTION	This indicates a situation that demands prompt and careful action, a specific remedy, or emergency attention.
	IMPORTANT	This indicates a situation or action that could potentially cause problems to the equipment and/or its operation.
	NOTE	This emphasizes important information or provides useful tips and hints.
	RADIATION	This indicates a possible danger from radiation exposure.
	SINGLE USE	This indicates a component that must be replaced for each new patient.
	ESD susceptibility	This indicates that an item is susceptible to damage from electrostatic discharges.

2.4 Marks and Symbols

Symbols	Description	Location
	Dangerous voltage	Power board / Inverter board / Monoblock
	Protective earth (Ground)	Column
	Off (power: disconnected to the Main Power Switch)	Main Power Switch
	On (power: connected to the Main Power Switch)	Main Power Switch
	Alternate current	Label
	Type B Applied Equipment (IEC 60601-1: Degree of protection against leakage current and/or electric shock: Class 1 equipment)	Label
	Radiation hazard	Label
	Indicates the authorized representative in the European Community.	Label
	The CE symbol indicates that this product complies with the European Directive for Medical Devices 93/42/EEC as amended by 2007/47/EC as a class IIb device.	Label
	UL mark No. E476672	Label
	Caution: Federal law restricts this equipment to sale by or on the order of a licensed healthcare practitioner.	Label
	Addresses where the equipment was manufactured.	Label

2. General Information

Symbols	Description	Location
	This indicates that electrical and electronic equipment must not be disposed of as unsorted municipal waste and must be collected separately.	Label
	Warns ESD hazard.	MCU board / Board package
	Indicates that this equipment is classified as a CLASS 1 LASER PRODUCT by IEC 60825-1 ED.2 regulations.	Label
	Indicates that the user needs to refer to the Instruction Manual .	Label
	Indicates the date of manufacture.	Label
	Indicates the manufacturer's serial number so that the specific equipment can be identified.	Label

2.4.1 Label Locations

The label is attached to the right side of the equipment and it consists of 5 parts as below.

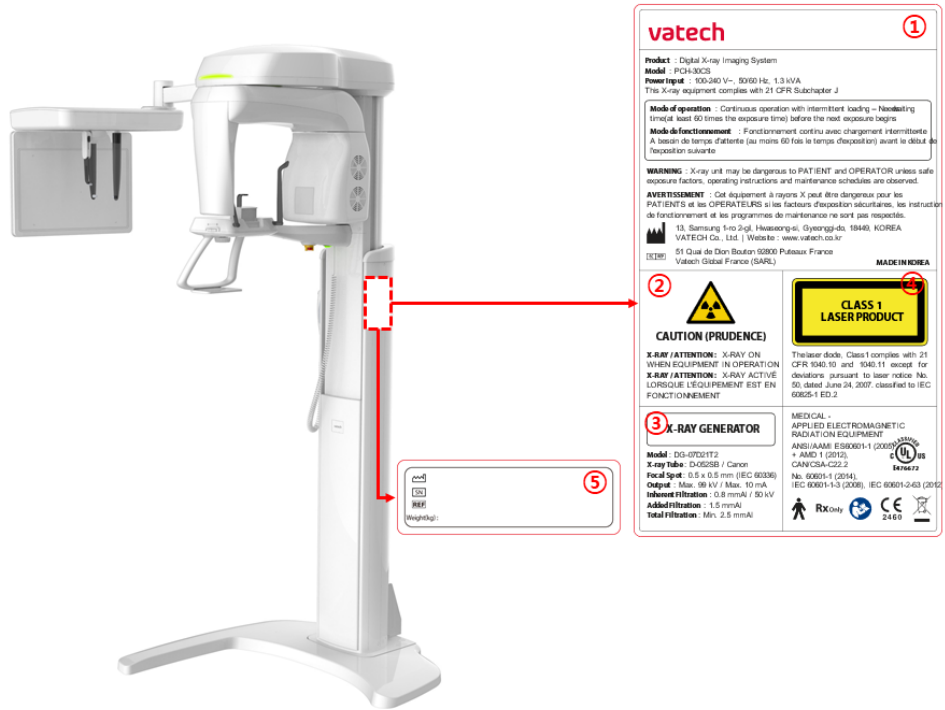

No.	Item
1	PaX-i Plus / PaX-i Insight (Model: PCH-30CS) Main Label
2	CAUTION Label - X-ray / Attention: X-ray on when equipment in operation.
3	X-RAY GENERATOR Label : 1.0 kW Generator
4	CLASS 1 LASER PRODUCT Label
5	Manufacturer Label - The date of manufacture / Serial Number / Weight of the equipment

This page intentionally left blank

3. Warnings and Precautions



Be sure to strictly observe all warnings and safety instructions included in this manual.



This x-ray unit may be dangerous to patients and operators unless safe exposure factors, operating instructions, and maintenance schedules are observed.

3.1 General Safety Guidelines

Operator qualifications

This equipment may only be operated by personnel fully trained in its operation.

- To operate this equipment, the operator must:
- Have read and understood the **User Manual**.
- Be familiar with the fundamental structure and functions of this equipment.
- Can recognize the irregular operation of this equipment and implement appropriate measures to remedy such irregularities.

General safety precautions

- Follow the instructions specified in this manual to ensure the safety of both the patient and the operator.
- The operator must maintain vocal/visual contact with the patient always during imaging.
- Do not open or remove the cover panels on this equipment. Always have a trained and authorized service technician to carry out inspection and maintenance of this equipment.
- Do not place any heavy objects on this equipment at any time.
- Do not place any objects within this equipment's field of operation. It may cause property damage.
- Do not push or pull the equipment. Overbalances of the equipment may cause the risk of physical injuries or property damage.
- The operator must instruct the patient to remain still until the equipment arm has stopped moving and the reset motion is completed.
- Observe all local fire regulations. Always keep a fire extinguisher near the equipment.
- The operator of this equipment must be familiar with this equipment's emergency protocols.

3. Warnings and Precautions

- Ensure that this equipment is kept away from water, moisture, or foreign substances always.
- If this product is exposed to water, moisture, or a foreign substance, immediately turn off the main power of the equipment and contact your **VATECH** technical support representative.
- If there are signs of oil leakage, immediately cease all operations of this equipment and contact your **VATECH** technical support representative.
- External equipment intended for connection to signal input, signal output, or other connectors, shall comply with relevant IEC Standard (e.g., IEC 60950 for IT equipment and IEC 60601-1series for medical electrical equipment).
- Besides, all such combination-system-shall comply with the standard IEC 60601-1 and/or IEC 60601-1-1 harmonized national standard or the combination. If, in doubt, contact a qualified technician or your local representative.
- Any person or organization that installs an external door interlock switch is responsible for ensuring that it has a radiation indicator or equivalent alarm system to show the state of the current.

Ventilation

- Do not close the equipment's ventilation slots in any case. The obstruction of ventilation could result in the equipment overheating due to a lack of air circulation.
- Do not spray any type of liquid or disinfectant on this equipment. The penetration of these substances may damage the electrical and mechanical components inside. Use a soft cloth to disinfect the ventilation slots.
- Always leave enough space around the PC to allow for proper ventilation.

Hygiene



- Always disconnect the equipment from the power outlet when disinfecting the surfaces of the equipment.
- Never expose this equipment to liquids, mists, or sprays. Exposing this equipment to liquids may cause an electric shock or otherwise damage the system.
- Do not use spray cleaners on the equipment, as this could cause a fire.

- All removable patient support components (the Bite, the Chinrest, the Temple Supports, and the Ear Rods) can be cleaned using non-alcohol-based cleaning solutions.
- Clean the Support Handles by using non-alcohol-based cleaning solutions before taking photos of the next patient.
- Other surfaces of the equipment can be cleaned using a soft cloth dampened with a mild cleaning solution.
- A new Sanitary Vinyl Cover must be provided for each new patient to prevent the transmission of communicable diseases.



NOTICE

If the Sanitary Vinyl Covers go out of stock, please contact the customer service or purchase additional ones (ISO10993-1) that have proven to be bio-compatible.

Condensation

- Extreme fluctuation in temperature may cause condensation to develop inside the equipment. Do not turn on the equipment until it has reached room temperature.

Cooling

- Allow the proper amount of cool downtime (for the X-ray tube to cool down) before the acquisition of the next image.
 - Mode of operation: Continuous operation with intermittent loading - Needs waiting time (at least 60 times the exposure time) before the next exposure begins
 - Column operation time: Max. 2 min. On / 18 min. Off (Ratio 1:9)
- If the temperature inside the tube head reaches 60 °C (140 °F), X-ray exposure will cease, and an error message will be displayed. Normal X-ray capabilities will resume after the generator reaches 58 °C (136.4 °F).
- If the fan (optional) is installed, it operates automatically when the temperature surrounding the tube head reaches the pre-defined level: 40 °C (104 °F). The setpoint temperature is configurable.

Turning the equipment on / Adjusting the height of the equipment

- Do not position the patient near the equipment while it is initiating as the patient could be injured if the equipment malfunctions.
- Ensure that the patient is kept clear of the equipment while adjusting its height.

Emergency stops

- If a problem occurs during image acquisition, press the red **Emergency Stop Switch** to immediately stop all moving parts and cut off all power to the equipment. (**Emergency Stop Switch** is located at the bottom of the Vertical Frame. Turn the switch in the direction of the arrow to reboot the equipment.)

Trouble-free operation

- Never use this equipment in an environment that is susceptible to explosion.
- Always operate the equipment within a temperature range of 10 °C to 35 °C (50 °F to 95 °F) for the safe operation. Image quality may deteriorate if the equipment is operated outside of this range.
- Always allow the equipment sufficient time to warm up (while switched on) if it has been exposed to temperatures below 10 °C (50 °F).
- Only perform X-rays of patients if the system is in full working order.
- Always ensure that equipment movement is not obstructed by the patient's clothing, a medical device (such as a wheelchair), or the patient.
- Do not leave the patient unattended around the equipment.
- Remove all radio-controlled devices, mobile phones, etc. from the X-ray room before image acquisition as these objects may cause the equipment to malfunction.

Modifying the equipment

- Modifying the equipment in any way which may affect the safety of the operator, patients, or other persons is prohibited by law.
- No part of this equipment is serviceable by the operator. All maintenance and repair of this equipment must be performed by a **VATECH** qualified service technician.
- This product may only be operated with original **VATECH** accessories or third-party accessories expressly approved by **VATECH**.

3.2 Electricity-related Safety Precautions



To avoid the risk of electric shock, this equipment must only be connected to supply mains with protective earth.

- Check the status of the power source, PC, and cables before operating the equipment.
- Ensure that **Main Power Switch** is set off when the equipment is not in use.
- Always disconnect the power supply before cleaning the equipment.
- Always keep electrical cords away from hot appliances or radiators.
- DO NOT place the PC or peripheral equipment connected to the PC near the patient.
- The equipment and PC should be connected to a common protective earth.
- Never overload the equipment's circuit by sharing it with too many appliances.
- Use the same power circuit for the PC and the equipment.

Combining this equipment with other devices

- Do not connect this equipment to devices that are not designated as a part of the system.
- Do not connect this equipment to a Multiple Portable Socket-Outlet (MPSO) or extension cord that is not provided with the equipment.

Electromagnetic compatibility

- This X-ray equipment complies with IEC standard 60601-1-2.
- Medical electrical equipment is subject to special Electromagnetic Compatibility (EMC) preventive measures. It must be installed and operated as specified in EMC information.
- If high-voltage systems, radio link systems, or MRI systems are located within 5 m of the unit, please observe the specifications stated in the installation requirements.
- Portable Radio Frequency (RF) communications equipment may interfere with medical electrical equipment. Therefore, the use of mobile wireless phones in medical offices or hospital environments must be prohibited.
- For more details, refer to **14.3 Electromagnetic Compatibility (EMC) Information**.
- Please also observe the Electro-Static Discharge (ESD) protective measures described.

Static Discharge

- Connector pins or sockets bearing ESD warning labels must not be touched or interconnected without observing ESD protective measures.



Electrostatic discharge (ESD)

ESD protective measures include

- Procedures for preventing electrostatic charge build-up (e.g. temperature control, humidification, conductive floor coverings, and non-synthetic clothing)
- Electrostatic discharge of your own body with the frame of the equipment, the protective ground wire, or large metallic objects
- Use of the wristband for grounding

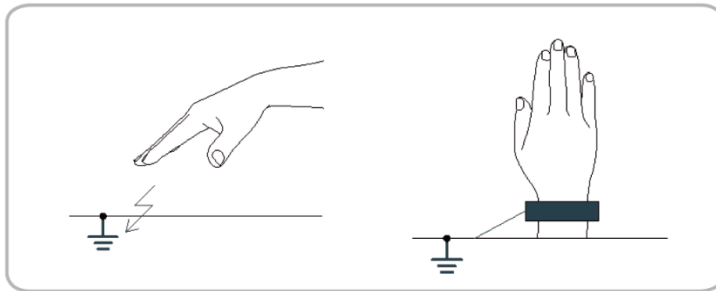

3.3 Radiation Safety



Since rules and regulations concerning radiation safety differ between countries, it is the responsibility of the owner and/or operator of this equipment to comply with all applicable rules and regulations concerning radiation safety and protection in his/her area.





- This equipment must be housed inside an X-ray shielded room.
- The operator must remain outside a shielded room during X-ray exposure to protect himself/herself from radiation.
- During imaging, the operator must maintain vocal/visual contact with the patient from outside the shielded area.
- The operator should continuously check the status of the patient and the equipment during imaging.
- The operator should be at least 2 m (6 feet) away from the equipment during imaging.
- The operator must immediately stop imaging if the equipment malfunctions.
- The patient must wear a lead apron with neck and thyroid protection during X-ray exposure.
- Children and pregnant women must consult with a doctor before X-ray exposure.



As a manufacturer of radiology equipment that conforms to stringent protection standards around the world, we guarantee the maximum degree of protection against radiation hazards for our equipment.

3.4 Warnings

The following warning statements should be obeyed with the utmost care. Failure to follow these warnings may cause severe damage to the equipment or physical injuries to the patient and/or the operator.

	<ul style="list-style-type: none"> ▪ X-ray equipment is hazardous to the patient and the operator if proper exposure safety measures and/or operating instructions are not observed. ▪ It is important to read this User Manual carefully and strictly abide by all warnings and cautions stated within it.
	<ul style="list-style-type: none"> ▪ Where it is likely that evaluation of soft tissues will be required as part of the patient's radiological assessment, conventional medical CT or MR should be used instead of dental cone beam imaging.
	<ul style="list-style-type: none"> ▪ PCH-30CS system, like other medical equipment, uses high-frequency electrical signals that can interfere with implantable devices such as pacemakers and Implantable Cardioverter Defibrillators (ICDs). If the patient has such an implantable device, you should be aware of any interference in its operation and immediately power off the Dental X-ray system. ▪ PCH-30CS system is designed to withstand the effects of defibrillation. However, when possible, disconnect the Dental X-ray system during defibrillation since a malfunction of the safety controls could otherwise result in electrical burns for the patient.
	<p>Federal law restricts this equipment to sale by or on the order of a dentist or with the descriptive designation of any other practitioner licensed by the law of the State in which he practices using or order the use of the equipment.</p>

Lasers

- The system incorporates Class 1 laser products. The light localizers used in this product are intended for correct patient positioning and must not be used for any other purpose.
- For maximum safety, advise the patient not to look directly at the laser beam.
- While adjusting the patient, ensure that the laser beam is not directed at the patient's eyes.
- Wavelength: 650 nm, Radiant power: Max. 0.39 mW

	<p>Risk of eye injury!</p> <p>Do not use this equipment with any other laser sources and do not make any changes to the settings or processes that are described in these operating instructions.</p>
---	---

Cleaning

- Never expose this equipment to liquids, mists, or sprays. Exposing this equipment to liquids may cause an electric shock or otherwise damage the system.
- Do not use spray cleaners on this equipment, as this could cause a fire.

During the Operation

- Never use this equipment in an environment that is susceptible to explosion.
- Do not place flammable materials near this equipment.
- Do not operate the PC while the equipment is operating. Failure to comply with this instruction may result in system malfunction.
- Immediately stop imaging if the equipment malfunctions in any way.
- If a problem occurs during imaging, press the red **Emergency Stop Switch** to immediately stop all moving parts and cut off all power to the equipment's electrical components.
- Never touch the patient while he or she is touching the SIP/SOP connectors.
- The medical electrical equipment or medical electrical system should not be used adjacent to or stacked with other equipment and that if adjacent or stacked use is necessary, the medical electrical equipment or medical electrical system should be observed to verify normal operation in the configuration in which it will be used.
- The use of accessories and cables other than those specified, except for cables sold by **VATECH** of the medical electrical equipment or medical electrical system as replacement parts for internal components, may result in increased EMISSIONS or decreased IMMUNITY of EQUIPMENT or SYSTEM.

In case of an electrical fire

- Use only fire extinguishers designed for electrical fires to extinguish fires on this equipment.

Liquid extinguishers, such as those which use water, could damage the equipment and/or cause physical injury.

- Unplug the equipment's power cable before extinguishing any fire.

Installation

- To avoid improperly balanced equipment, install the equipment on a flat surface to maintain stability.
- If the equipment is not stable, property damage and/or personal injury may occur.
- Do not push or pull the equipment.
- Equipment should only be installed by an authorized technician, complying with proper installation procedures.

NOTICE

For further details on installation, refer to the **PaX-i Plus / PaX-i Insight (Model: PCH-30CS) Installation Manual**.

Security Capabilities

- It is recommended to install and operate **EzDent-i / EasyDent** SW within a secure operating environment that allows only authorized users to access and a system network equipped with Windows built-in firewall, Windows Defender antispyware tools, and other commonly used 3rd party security tools and application systems.
- The latest updates for anti-virus software and a firewall are recommended.
- The software can be updated by the manufacturer only. Unauthorized software update through a third party, not the manufacturer, is strictly prohibited. For cybersecurity issues related to the software and medical devices, please contact the manufacturer.

Side effects

- There are no known side effects from the use of this equipment.

4. Imaging System Overview

4.1 System Components

- **PaX-i Plus / PaX-i Insight (Model: PCH-30CS)** X-ray equipment
- PC system
- Console Software: PANO and CEPH (Optional)
- **EzDent-i / EasyDent:** 2D viewer and patient management software

4.2 Features



- The multi-imaging solution for Accurate Diagnostics
- Conventional 2D (PANO and CEPH (Optional)) image acquisition in high quality
 - **PANO:** Optionally implemented improved multi-image acquisition technology that reconstructs the panoramic image into multiple images with different focal planes at one take.
 - **CEPH:** Minimized motion artifact through short scan time
- DICOM (Digital Imaging Communication in Medicine) format supported

4.3 Standards and Regulations

Standards

PaX-i Plus / PaX-i Insight (Model: PCH-30CS) is designed and developed to comply with the following international standards and regulations:

- MEDICAL - APPLIED ELECTROMAGNETIC RADIATION EQUIPMENT
AS TO ELECTRICAL SHOCK, FIRE, AND MECHANICAL HAZARDS ONLY IN ACCORDANCE WITH
ANSI/AAMI ES60601-1 (2005) + AMD 1 (2012),
CAN/CSA-C22.2 No. 60601-1 (2014), IEC 60601-1-3 (2008), IEC 60601-2-63 (2012)
- 21 CFR 1020.30, 31, 33
- NEMA Standard publication PS 3.1-3.18

	<p>This is Class IIb equipment and obtained CE marking in April 2007 for regulations compliance in accordance with the revised European Union's MDD (Medical Devices Directive) 93/42 EEC.</p>
	<p>This equipment received the UL certification mark in accordance with ANSI/AAMI, CAN/CSA-C22.2 No. 60601-1 regulations.</p>

Classifications (IEC 60601-1 6.1)

- The degree of protection against water ingress: Ordinary Equipment: IPX0
- The degree of protection against electric shock: Class 1 equipment, Type B Applied Parts: Temple Supports, Chinrests, and Bites.



4.4 Operating Principles

X-ray is emitted when a high voltage is supplied to the X-ray tube assembly which frees electrons from the cathode.

They hit anode to produce an X-ray. The machine acquires images by emitting X-rays continuously and rotates on the human tooth at different angles.

Images are acquired, computed, and recompiled to reproduce 2D images.

4.5 Imaging System Configuration

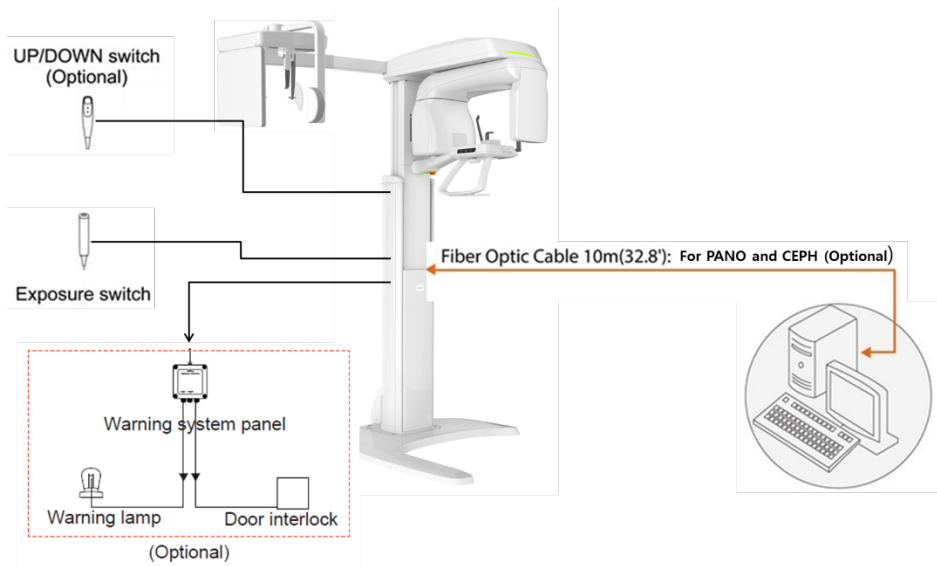

Input / Output for PC

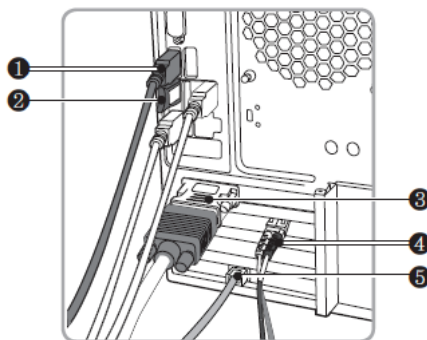

No.	Item
1	USB Camera input (USB 3.0 Cable)
	<div style="border: 1px solid black; padding: 5px; display: inline-block;">NOTICE</div> To avoid any connection problem, it is highly recommended to install a USB 3.0 PCI card for USB 3.0 cables.
2	2D viewer License Key
3	Video Output
4	Fiber Optic Cable (Data in / out)
5	Ethernet Cable

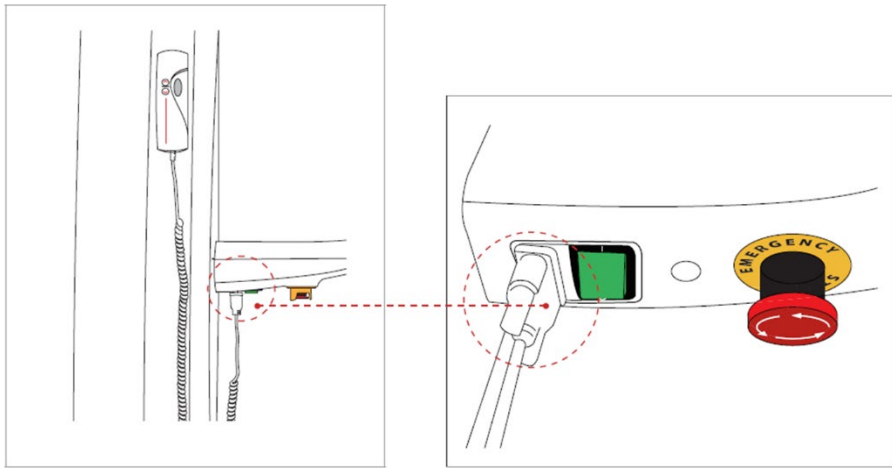
Signal Input & Output for Column UP/DOWN Switch**NOTICE**

The equipment connected to the signal input, signal output, or other connectors must comply with the relevant IEC standards (e.g., IEC60950 for IT equipment and IEC60601-1 series for medical electrical equipment).

Besides, all such combination systems must comply with IEC60601-1 and/or relevant combination standards. If in doubt, contact a qualified technician or your local VATECH representative.

4.6 Equipment Overview

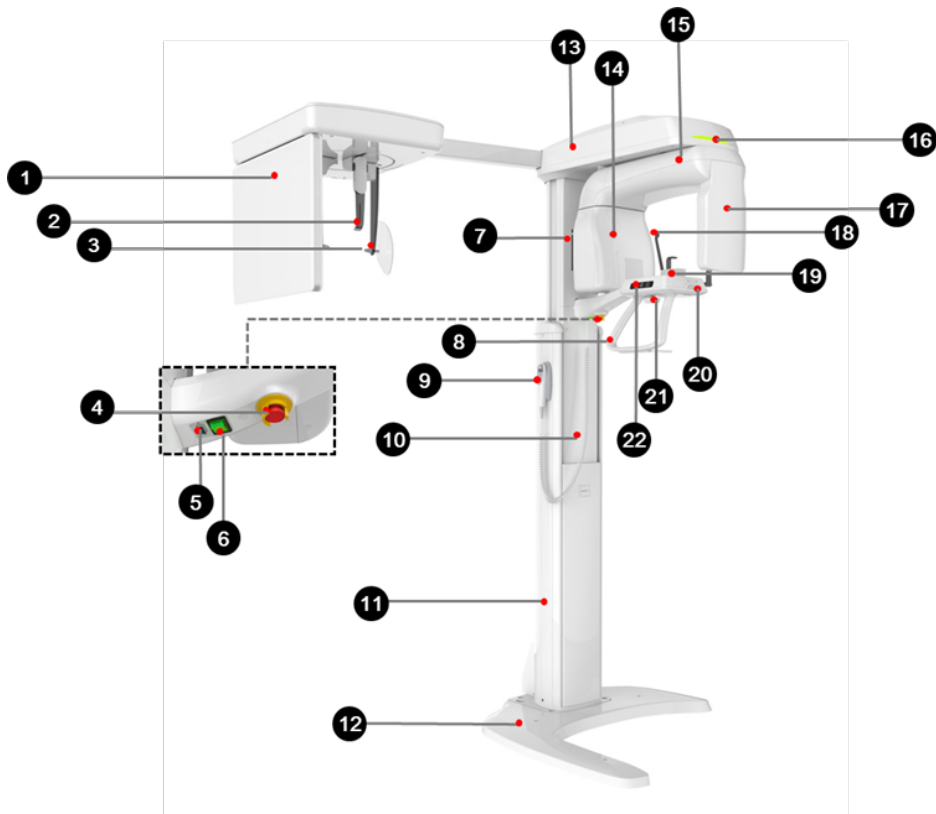

No.	Item	Description
1	X-ray Detector for CEPH (Optional)	Xmaru2602CF for CEPH imaging sensor
2	Nasal Positioner	– Positions the patient during CEPH imaging. – The ruler is used for reference in an acquired image that is different from the actual size
3	Ear Rods	Secure the patient's head during CEPH imaging.
4	Emergency Stop Switch	Immediately stops the moving parts and cuts off all power to the equipment's electrical components.
5	D-Sub Connector	The input signal port for Column UP/DOWN Switch
6	Main Power Switch	Turns on / off the main power of the equipment.
7	Horizontal Beam Lever	Aligns the Horizontal Beam in PANO mode.
8	Handle Frame	Held firmly by the patient during imaging to stabilize his / her position.
9	Column	Adjusts the height of the Vertical Frame.

No.	Item	Description
	UP/DOWN Switch (optional)	
10	Telescopic Column	Moves by the Column UP/DOWN button or switch for patient positioning.
11	Stationary Column	Supports the whole part of the equipment.
12	Base (Optional)	Balances the equipment and maintains its safety.
13	Vertical Frame	Holds the Rotating Unit. Can be controlled by Column UP/DOWN switch.
14	X-ray Generator	The vacuum tube where the X-ray is produced.
15	Rotating Unit	Rotates around the patient's head while the image is being acquired. (Its movement is different according to the scan mode.)
16	LED Lamp	Displays the status of X-ray exposure. - Green: Standby - Yellow: In operation
17	X-ray Detector for PANO	<ul style="list-style-type: none"> ▪ PaX-i Plus: Xmaru1501CF-PLUS ▪ PaX-i Insight: Xmaru1404CF-PLUS
18	Temple Supports	Supports the patient's head by holding the temples. Used in the PANO mode.
19	Chinrest	The place to rest the chin.
20	Canine Teeth Beam Lever	Aligns the Canine Teeth Beam in PANO mode.
21	Temple Supports OPEN/CLOSE Wheel	Adjusts the Temple Supports for patient positioning.
22	Control Panel	Operates the Laser Beam and adjusts the height of the Vertical Frame. (For the details, refer to 4.6.1 Control Panel.) 

4.6.1 Control Panel

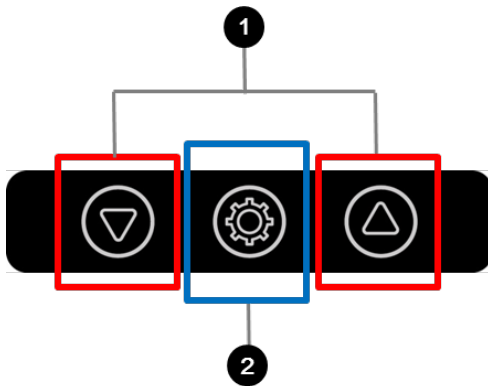

No.	Item	Description
1	Column UP/DOWN button	Moves the Vertical Frame up or down. (For adjusting the height of the Chinrest)
2	Laser Beam ON/OFF button	Turns the Laser Beam on / off.

4.6.2 Emergency Stop Switch

During operation, the following emergencies may occur:

- X-ray emission even after the **Exposure Switch** has been released
- Physical injury to the patient or damage to the equipment
- Other emergencies

If a problem occurs during image acquisition, press the red **Emergency Stop Switch** to immediately stop the moving parts and cut off all power to the equipment's electrical components. To restart the equipment, turn the **Emergency Stop Switch** clockwise until it pops up.

The **Emergency Stop Switch** is located at the bottom of the Vertical Frame.



4.6.3 Exposure Switch

The **Exposure Switch** allows the operator to control image acquisition from outside of the X-ray room.

Press and hold the **Exposure Switch** down until acquisition is completed. Premature release of the **Exposure Switch** will abort image acquisition.

Pressing the **Exposure Switch** activates the LED indicator to turn yellow. This color indicates that the X-ray is being emitted.

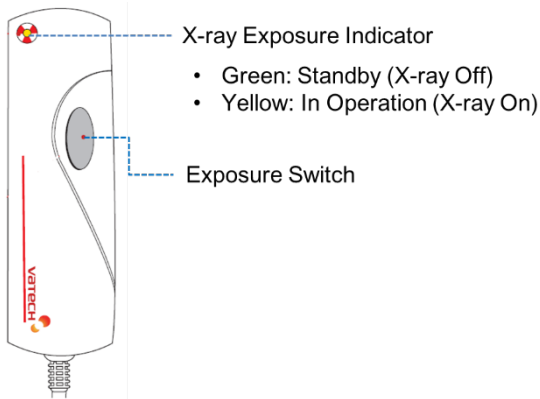











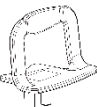

IMPORTANT

- The **Exposure Switch** is detachable. Ensure the **Exposure Switch** cable is not detached from the unit accidentally during the operation.
- Keep vocal/visual contact with the patient during exposure. If any problem occurs during exposure, release the **Exposure Switch** immediately.

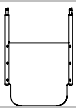
4.6.4 Enclosed Components

The enclosed components can be disassembled and cleaned. All enclosed components that are used to support the patient (the Bite, the Chinrest, the Ear Rods, and the Temple Supports) should be cleaned with ethanol and wiped with clean towels.

Components	Name and Function	Materials
	Normal Bite : For PANO	PC (Polycarbonate)
	Deep Bite Block*	PC (Polycarbonate)
	SINUS/TMJ bite	PC (Polycarbonate)
	Edentulous Bite : For PANO edentulous patients	PC (Polycarbonate)
	Normal Chinrest : For Normal Bite	ABS (Acrylonitrile butadiene styrene) copolymer
	Temple Supports (1 set)	PC (Polycarbonate)
	Ear Rods (1 set)	Silicone
	Nasal Positioner Cover : For CEPH	Silicone
	Carpus Plate	PC (Polycarbonate)
	Sanitary Vinyl Covers (disposable) for the Bite 	LDPE (Low-density polyethylene)
	Protractor (1 set) : For positioning the patient's body in CEPH mode.	PC (Polycarbonate)

*. Deep Bite Block is only available in some Asian countries.

5. Imaging Software Overview

Three programs are included in this equipment to acquire, process, and view the image:

- **EzDent-i / EasyDent:** 2D viewer and patient management software
- **Console software (v1.0):** PANO and CEPH (Optional)
- PC Specifications (Recommended)

NOTICE

- The PC system plays an important role in image processing and verification. Configure the PC environment to meet the following specifications. If the PC specifications are not met, the image quality can be lower.
- Do not place patients near the equipment and PC.

■ PaX-i Plus

Item	Specifications
CPU	Intel Core i3-7100 3.9GHz 3MB Cache, 2cores
Chipset	Intel Q270
RAM	2X4GB DDR4-2400 DIMM NECC UNB
Hard disk drive	500GB SATA 7200 rpm
Graphics board	Integrated Intel HD 630 Graphics
Ethernet interface	Integrated Intel I219LM Gigabit Network Intel Ethernet I210-T1 PCIe x1 Gb NIC (Option)
Serial Port (RS232)	1 (Onboard)
Power supply	≥ 400 Watts (93% Efficiency)
Slots	2 PCI Express x 1 Slot 2 PCI Express x 16 Slot
CD/DVD drive	DVDRW
Operating system	Windows 10 Professional 64 bit



WARNING

If you need to install a grabber card, plug it into the x4 express slot.

■ PaX-i Insight

Item	Specifications
CPU	Intel Core i5-7500 3.4 2133 4C CPU
Chipset	Intel C236 Chipset
RAM	16GB DDR4-2400 nECC (2X8GB) Unbuffered RAM
Hard disk drive	1TB SATA 7200 1st HDD
Graphic board	NVIDIA GTX 1050Ti
Ethernet interface	Integrated Intel® I218LM PCIe GbE Controller
Serial Port (RS232)	PCIe type RS232 Port
Power supply	400W (90% efficiency)
Slots	2 PCIe Gen3 x 16 slot
	1 PCIe Gen3 x 8 slot
	1 PCIe Gen2 x 4 slot
	1 PCIe Gen2 x 1 slot
	1 PCIe 32bit/33MHz
CD/DVD drive	DVDRW
Operating system	Windows 10 Professional 64 bit

IMPORTANT

In Windows 10, disable Windows Defender  When Windows Defender is not enabled, Windows 10 is not protected from malware and virus.

5.1 EzDent-i / EasyDent

EzDent-i / EasyDent is imaging software from **VATECH Co., Ltd.** that manages patient images to make faster and more accurate diagnoses. **EzDent-i / EasyDent** linked with the console software makes it convenient for the operator to use and process necessary images. Various functions enable the acquired images to be processed quickly and conveniently from the console software.

NOTICE

Please note that **EzDent-i** supports both **PaX-i Plus** and **PaX-i Insight** while **EasyDent** supports **PaX-i Plus** only.

NOTICE

Please refer to **6.2.1 Creating a New Patient Record** and **6.2.2 Retrieving Patient Records** and **EzDent-i / EasyDent User Manual** for more information.

NOTICE

Security Capabilities

- It is recommended to install and operate **EzDent-i / EasyDent** SW within a secure operating environment that allows only authorized users to access, and a system network equipped with Windows built-in firewall, Windows Defender antispysware tools, and other commonly used 3rd party security tools and application systems.
- The latest updates for anti-virus software and a firewall are recommended.
- The software can be updated by the manufacturer only. Unauthorized software update through a third party, not the manufacturer, is strictly prohibited. For cybersecurity issues related to the software and medical devices, please contact the manufacturer.

5.2 Console Software

Use the Console Software to configure the imaging environment according to the mode.

NOTICE

- You can set the imaging parameters on the Console Software running on the PC. They are synchronized and display the same environmental settings.)
- To improve program functions, the Console Software may change without notice

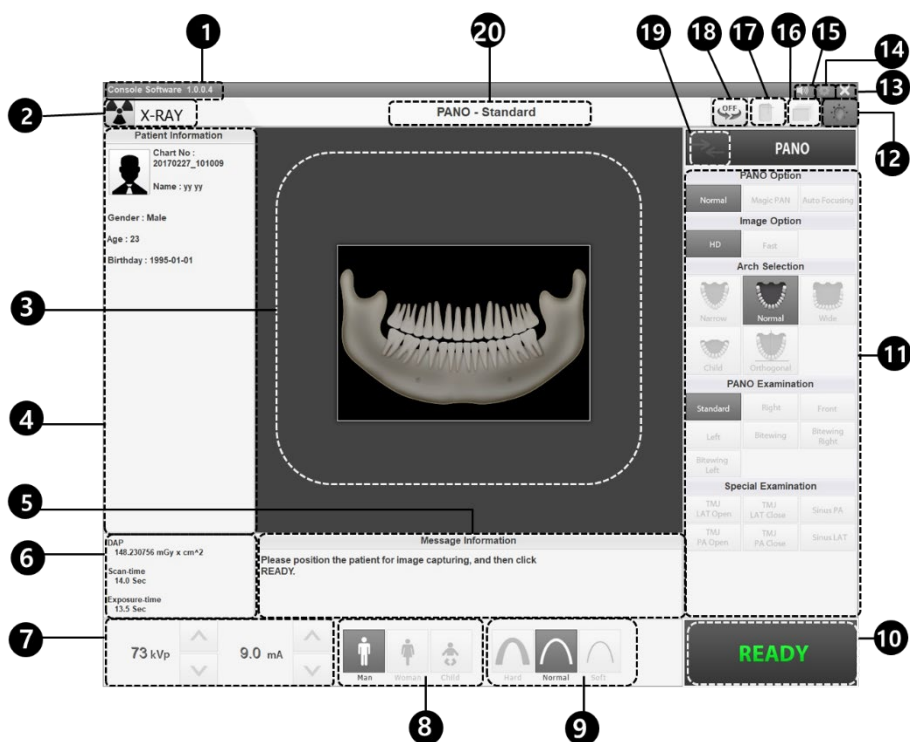

The Main Screen of the Console Software consists as follows. Each imaging mode will be described later.

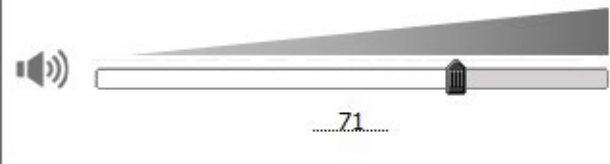

No.	Item	Description
1	Version Information	Displays the Console Software version.
2	X-ray indicator	The radiation mark turns yellow and "X-RAY" changes to "X-RAY ON". 
3	Scanning Status and Image Preview window	Shows image acquisition progression and display a preview of the images acquired.

No.	Item	Description																				
4	Patient Information window	Displays information on the selected patient.																				
5	Guide Message window	Displays various text instructions for the operator.																				
6	DAP, Scan Time, and Exposure Time Display window	Displays estimated DAP (Dose Area Product), scan time, and exposure time after exposure parameter settings are completed.																				
7	Tube Voltage and Current Adjustment	<p>If the patient is selected in EzDent-i / EasyDent, the default kVp / mA according to the patient's information (gender/age) is displayed. This tool adjusts the kVp and mA values and controls the power of the X-ray to improve image quality. If necessary, adjust the kVp and mA values manually using the arrows.</p> <hr/> <p>NOTICE</p> <p>For the tube voltage and its correspondence with the selected patient, refer to the 14.1 Recommended X-ray Exposure Table.</p>																				
8	Patient's gender/age group	<p>Displays the current patient's gender/age group as entered in EzDent-i / EasyDent's patient information fields. If necessary, the gender/ age group can be manually selected.</p> <table border="1"> <thead> <tr> <th colspan="2">Gender / Age Group</th> <th>VATECH's Standard</th> </tr> </thead> <tbody> <tr> <td colspan="2">Child</td> <td>2 ~ 12 years of age</td> </tr> <tr> <td rowspan="2">Adult</td> <td>Man</td> <td rowspan="2">> 12 years of age</td> </tr> <tr> <td>Woman</td> </tr> </tbody> </table>	Gender / Age Group		VATECH's Standard	Child		2 ~ 12 years of age	Adult	Man	> 12 years of age	Woman										
Gender / Age Group		VATECH's Standard																				
Child		2 ~ 12 years of age																				
Adult	Man	> 12 years of age																				
	Woman																					
9	X-ray intensity	<p>Selects X-ray intensity.</p> <hr/> <p>NOTICE</p> <p>Depending on the circumference of the patient's head, X-ray intensity may be classified as Hard, Normal, or Soft: Soft ≤ Normal ≤ Hard</p> <table border="1"> <thead> <tr> <th>Age Group</th> <th>Average Head Circumference (cm)</th> <th>Range (cm)</th> <th>X</th> </tr> </thead> <tbody> <tr> <td rowspan="3">Child</td> <td rowspan="3">53±3</td> <td>>53±3</td> <td></td> </tr> <tr> <td>53±3</td> <td></td> </tr> <tr> <td><53±3</td> <td></td> </tr> <tr> <td rowspan="3">Adult</td> <td rowspan="3">56±3</td> <td>>56±3</td> <td></td> </tr> <tr> <td>56±3</td> <td></td> </tr> <tr> <td><56±3</td> <td></td> </tr> </tbody> </table>	Age Group	Average Head Circumference (cm)	Range (cm)	X	Child	53±3	>53±3		53±3		<53±3		Adult	56±3	>56±3		56±3		<56±3	
Age Group	Average Head Circumference (cm)	Range (cm)	X																			
Child	53±3	>53±3																				
		53±3																				
		<53±3																				
Adult	56±3	>56±3																				
		56±3																				
		<56±3																				
10	CONFIRM / READY button	<p>CONFIRM</p> <p>Applies the selected settings and moves to the next step. (Exposure parameter setting and patient positioning > Ready for exposure)</p>																				

No.	Item	Description
		<div data-bbox="588 326 805 382" style="border: 1px solid black; background-color: #0056b3; color: white; padding: 5px; display: inline-block; margin-bottom: 10px;">NOTICE</div> <p>When you click the CONFIRM button, estimated DAP (Dose Area Product), scan time and exposure time will be displayed DAP, Scan Time, and Exposure Time Display window.</p> <hr/> <div data-bbox="574 452 702 490" style="background-color: #cccccc; padding: 2px;">READY</div> <p>Activated when you click the CONFIRM button after the patient positioning is completed. Click the button when all aspects of preparation are completed for image acquisition.</p>
11	Imaging parameters configuration panel	Selects the imaging parameters for each mode: PANO and CEPH (Optional)
12	Laser Beam ON/OFF button	Turns the Laser Beam on or off for patient positioning. Enabled when the CONFIRM button is clicked after the imaging conditions are configured.
13	EXIT button	Exits the console software.
14	Settings button	Displays and sets various equipment-related parameters, including language, automatic save, DAP display unit, etc.
15	Speaker Volume button	<p>This button is used to adjust the speaker volume. Clicking on the speaker icon brings up the volume control bar, and you can adjust the volume by clicking and moving the volume control bar with your mouse. After moving the bar, release the mouse to play the current volume and save the current volume.</p> <div data-bbox="577 1147 1184 1309" style="text-align: center;">  </div>
16	Phantom button	<p>This function is used to acquire Phantom images.</p> <hr/> <div data-bbox="588 1514 805 1570" style="border: 1px solid black; background-color: #0056b3; color: white; padding: 5px; display: inline-block; margin-bottom: 10px;">NOTICE</div> <p>Image acquisition using the Phantom Jig:</p> <ol style="list-style-type: none"> 1. Click the Phantom button. 2. Select the Modality and click the Capture button. 3. Check the parameters displayed in the main GUI window and align the Phantom Jig, and then click the READY button. 4. Press and hold down the Exposure Switch.

No.	Item	Description
17	Manual Reconstruction button	Reconstructs the image manually when automatic image reconstruction fails: Select a Modality after clicking this button. > Click the Search button. > Select an image to reconstruct. > Click the Reconstruction button.
18	Rotation Test button	<p>Switches to the Rotation Test mode to check if any part of the patient's body reaches the surface of the equipment before the actual exposure.</p> <p>To change to the Rotation test mode,</p> <ol style="list-style-type: none"> 1. Align the patient to the equipment. (For the details, refer to the "Positioning the Patient" section of each modality chapter.) 2. Select a modality. 3. Click the CONFIRM button. 4. Click the Rotation Test button. Then, the button is changed to the OFF state and icon. <div style="display: flex; justify-content: center; gap: 10px;">   </div> <ul style="list-style-type: none"> ● To start the rotation test, press the BEAM ON/OFF button on the Control Panel. <p>To finish the test mode, click the Rotation Test button or READY button.</p> <hr/> <div style="display: flex; align-items: center;"> <div style="border: 1px solid black; padding: 2px 5px; background-color: #0056b3; color: white; font-weight: bold; font-size: 1.2em; margin-right: 10px;">NOTICE</div> <p>This function is applied to PANO and CBCT modalities only.</p> </div>
19	Modality Selection button	Returns to Modality Selection (PANO and CEPH (Optional)) screen.
20	Imaging Mode Display	Displays the current imaging mode.

This page intentionally left blank

6. Getting Started

6.1 Turning on the Equipment



- Do not place the patient close to the equipment when it's being turned on. Doing so may cause physical injury to the patient and damage to the equipment.
- Do not operate the PC while the equipment is in operation. Doing so may cause an error in the equipment.



- The extreme fluctuation of temperature may cause condensation inside the equipment. Do not switch on the equipment until it has reached normal room temperature.
- Rebooting the equipment: After turning it off, wait for approx. 20 seconds before turning it on again.
- Warm up the equipment for at least 5 minutes before the operation. For the best image quality, it is recommended to have a warm-up phase for more than 30 minutes.

IMPORTANT

If the equipment has not been used for a long time, please let it have enough time to be warmed up. It extends the life of the X-ray tube.

- The imaging system mainly consists of the imaging equipment and the PC.
- Before turning on the equipment, please confirm that the equipment and PC have been installed correctly.
- Turn on the PC.
- Press the **Main Power Switch** that is located at the bottom of the Vertical Frame to turn on the equipment.



NOTICE

Main Power Switch isolates its circuits electrically from the supply mains on all poles simultaneously.

- Make sure that the green LED light at the top of the **equipment** is on.

6.2 Running the Image Viewer (EzDent-i / EasyDent)

The Imaging Program is interfaced with **EzDent-i / EasyDent** and the user can analyze the image acquired from the Console Software easily and rapidly. On your desktop, double-click **EzDent-i / EasyDent** icon. The **EzDent-i / EasyDent** main window will be displayed.

NOTICE

Please note that **EzDent-i** supports both **PaX-i Plus** and **PaX-i Insight** while **EasyDent** supports **PaX-i Plus** only.

NOTICE

For further details on this subject, refer to the **EzDent-i / EasyDent User Manual**.

NOTICE

Security Capabilities

- It is recommended to install and operate **EzDent-i / EasyDent** SW within a secure operating environment that allows only authorized users to access and a system network equipped with Windows built-in firewall, Windows Defender antispymware tools, and other commonly used 3rd party security tools and application systems.
- The latest updates for anti-virus software and a firewall are recommended.
- The software can be updated by the manufacturer only. Unauthorized software update through a third party, not the manufacturer, is strictly prohibited. For cybersecurity issues related to the software and medical devices, please contact the manufacturer.

NOTICE

For the **PCH-30CS** dental computed tomography X-ray system, the Console Software is being accessed through 2D viewer (**EzDent-i / EasyDent**) SW. The Console Software does not have an image storage capacity of its own and both programs will not be able to keep patient information.

6.2.1 Creating a New Patient Record

To create a new patient record, follow the procedure outlined below:

EzDent-i

1. Click the **PATIENT** tab and click the **Add Patient** icon from the main GUI window.



2. Enter the required patient information. **Chart Number**, **E-Mail address**, **First Name**, and **Last Name** are required fields that must be filled in. (The Chart Number is filled in automatically.)
3. Click the **Add** button to save the patient record.

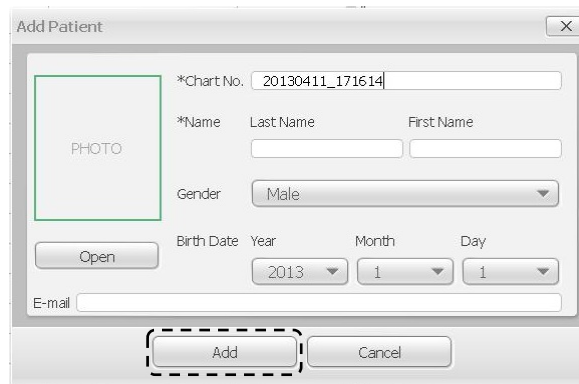

EasyDent

1. Click the **Patient** icon in the upper left corner of **EasyDent's** main GUI window.



2. Enter the required patient information. **Chart Number**, **First Name**, and **Last Name** are required fields that must be filled in. All other fields are optional, but it is recommended that they are filled in.

Chart No. : 20111229_180547 Auto Auto No.

* First Name :

* Last Name :

Social ID :

Birthday : 2011 1 1

Gender : Male Treatment : Treatment

Address1 :

Address2 :

E-mail :

Tel : Mobile :

Doctor :

Add Cancel

3. Click the **Add** button to save the patient record.

6.2.2 Retrieving Patient Records

You can search through the patient database using a patient's Chart Number, First Name, or Last Name.

EzDent-i

1. Enter the Name or Chart Number of the patient to be searched on the **Patient Search** panel and then click the **Search** button. The information on the patient that fits the search condition appears.



Double-click the Keyboard icon to display the virtual keyboard. You may search for patient information using the virtual keyboard.

NOTICE



2. Double-click the patient information to see more details about the patient as shown below.

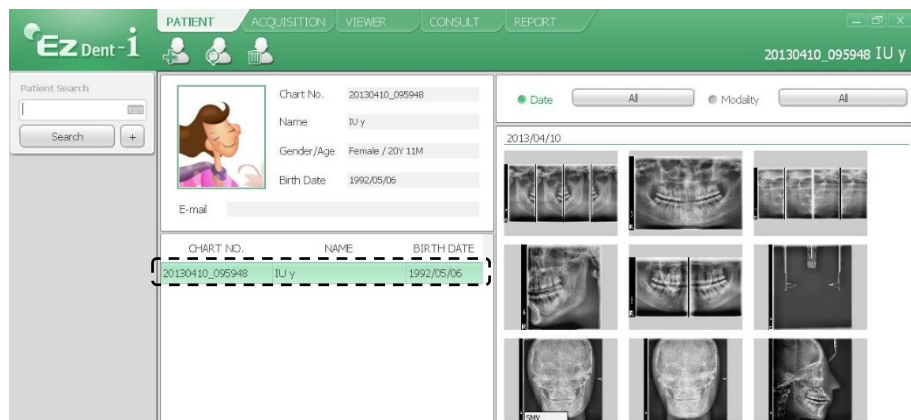

EasyDent

1. On the **Patient Information** pane, double-click the Chart No., First name, or Last name of the patient, and the virtual keyboard will pop up.



2. Enter the **Chart No.**, **First name**, or **Last name** of the patient by clicking the mouse on the virtual keyboard and click **Enter** key. (The physical keyboard can be used to do the same job)
3. Patient information can be displayed in the **Patient Information** panel and **Patient List**.

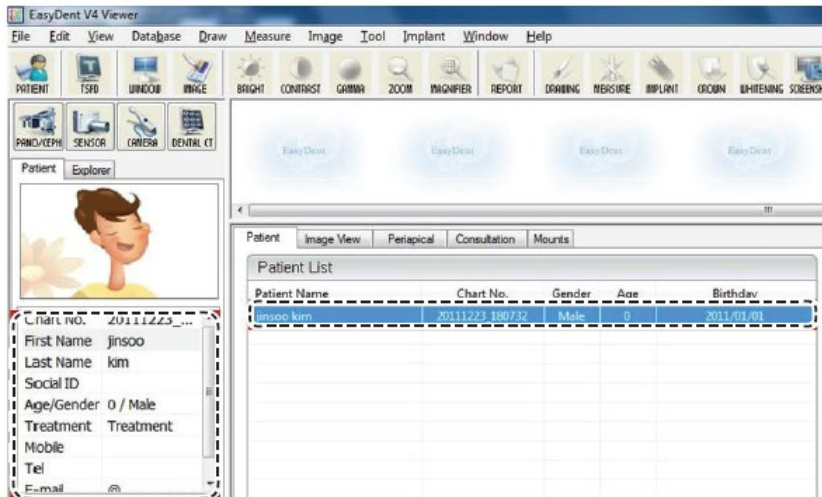

6.3 Initiating the Console Software

NOTICE

For a new patient, the patient information needs to be registered first.

EzDent-i

1. Search and select the patient to be captured.

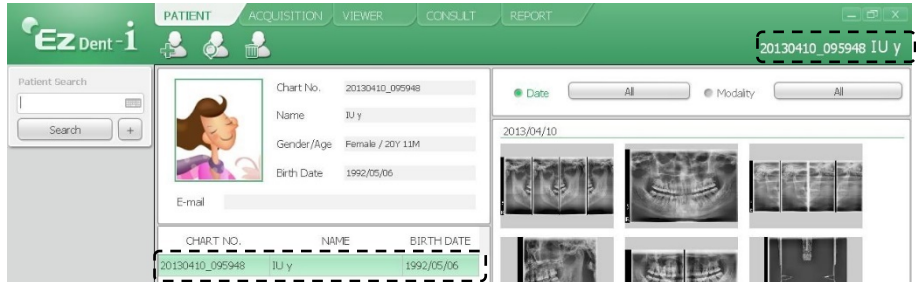

2. Click the **ACQUISITION** tab and select the imaging mode (Panorama, or Cephalo).

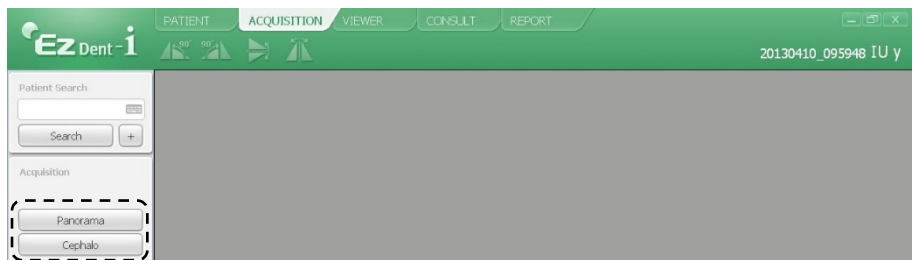

3. The Main Screen for the selected mode appears. From the Main Screen, you can configure the imaging parameter settings before acquiring an image.

NOTICE

Refer to the following **chapters (7 & 8)** for more information on image acquisition.

EasyDent

1. First, click the patient information in the **Patient List**, and click an imaging modality button to select on the upper left corner.



2. The Main Screen for the selected mode appears. From the Main Screen, you can configure the imaging parameter settings before acquiring an image.

NOTICE

Refer to the following **chapters (7 & 8)** for more information on image acquisition.

7. Acquiring PANO Images

7.1 PANO Imaging Program Overview

- **Result Images**

It provides conventional 2D panoramic images.

- **Image Acquisition Method**



It reconstructs U-shaped arch data to a single 2D image utilizing multiple images taken with the X-ray beam scanning specific oral & maxillofacial regions at different angles.





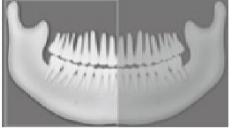

- **Available PANO Options**

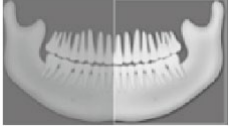
Mode	Description
Normal	Ordinary panoramic image acquisition option.
Auto-Focusing (Optional)	Multi-image acquisition option that reconstructs the panoramic image as multiple focal images.
Insight PAN	Multi-image acquisition option that reconstructs the panoramic image into multiple focal images in depth regions. Its main purpose is to diagnose depth regions, which cannot be confirmed with ordinary panoramic images.

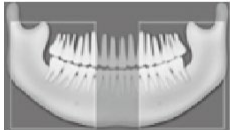
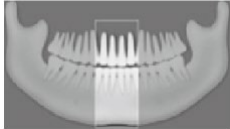
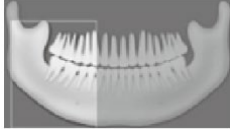
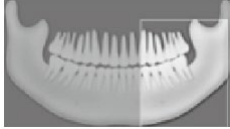
- **Examination Programs**





It is classified as below based on the ROI (Region of Interest).

Examination Type	Arch Selection	ROI	Example
PANO Examination	Narrow Normal Wide Child Orthogonal	Standard	
		Right	
		Front	
		Left	



Examination Type	Arch Selection	ROI	Example
	Orthogonal	Bitewing*	
		Bitewing Incisor* (Optional)	
		Bitewing Right*	
		Bitewing Left*	
SPECIAL Examination	N/A	TMJ LAT Open	
		TMJ LAT Close	
		TMJ PA Open (Optional)	
		TMJ PA Close (Optional)	
		Sinus LAT (Optional)	
		Sinus PA	

* Bitewing imaging mode is activated only when Orthogonal is selected in Arch Selection.

■ Main Imaging Programs

Examination Type	Arch Selection	ROI	Description & Sample Image	
PANO Examination	Narrow	Standard	A panoramic imaging mode for patients with a V-shaped arch trajectory. (Typically for some females) 	
	Normal	Standard	A panoramic imaging mode for adult patients with a normal arch trajectory. 	
	Wide	Standard	A panoramic imaging mode for the patients with a square-shaped arch trajectory. (Typically for some males) 	
	Child	Standard	A panoramic imaging mode for child trajectory. (Less X-ray exposure than the Normal mode by approximately more than 40%) 	
	Orthogonal		Standard	A panoramic imaging mode to minimize the overlapped region of the teeth from the X-ray exposure which is beamed perpendicularly between teeth. 
			Bitewing** (Bitewing Incisor mode is Optional)	A panoramic imaging mode to acquire an image only for the region of interest through the orthogonal trajectory. (Pros: less X-ray exposure than the Normal mode. / Cons: TMJ and some parts of the maxillary sinus cannot be acquired.)

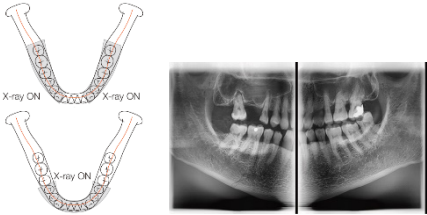
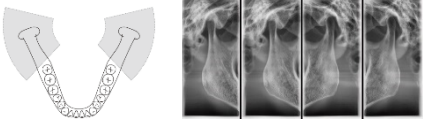
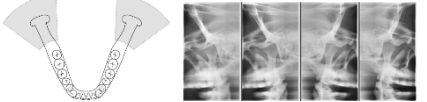
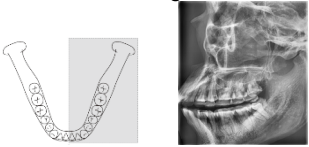
7. Acquiring PANO Images

Examination Type	Arch Selection	ROI	Description & Sample Image
			
SPECIAL Examination	N/A	TMJ LAT Open / Close	<p>An imaging mode to acquire a lateral image of the TMJ, in which the X-ray beam is directed on the lateral TMJ region. (TMJ Open and Close)</p> 
		TMJ PA Open / Close (Optional)	<p>An imaging mode to acquire a TMJ image, in which the X-ray beam is directed on the frontal TMJ, with the patient's mouth open fully and close.</p> 
		Sinus LAT (Optional)	<p>A special imaging mode to acquire a Sinus image, in which an X-ray beam is directed on the lateral region of the maxillary sinus.</p> 
		Sinus PA	<p>A special imaging mode to acquire a Sinus image, in which an X-ray beam is directed on the frontal region of the maxillary sinus.</p> 

** Bitewing imaging mode is activated only when Orthogonal is selected in Arch Selection.

7.2 Configuring Exposure Parameters

To acquire PANO Images, **6. Getting Started** must be completed first. If not, you must return to the **6. Getting Started** and finish the step first.

NOTICE

You can set the imaging parameters on the Console Software running on the PC. They are synchronized and display the same environmental settings.

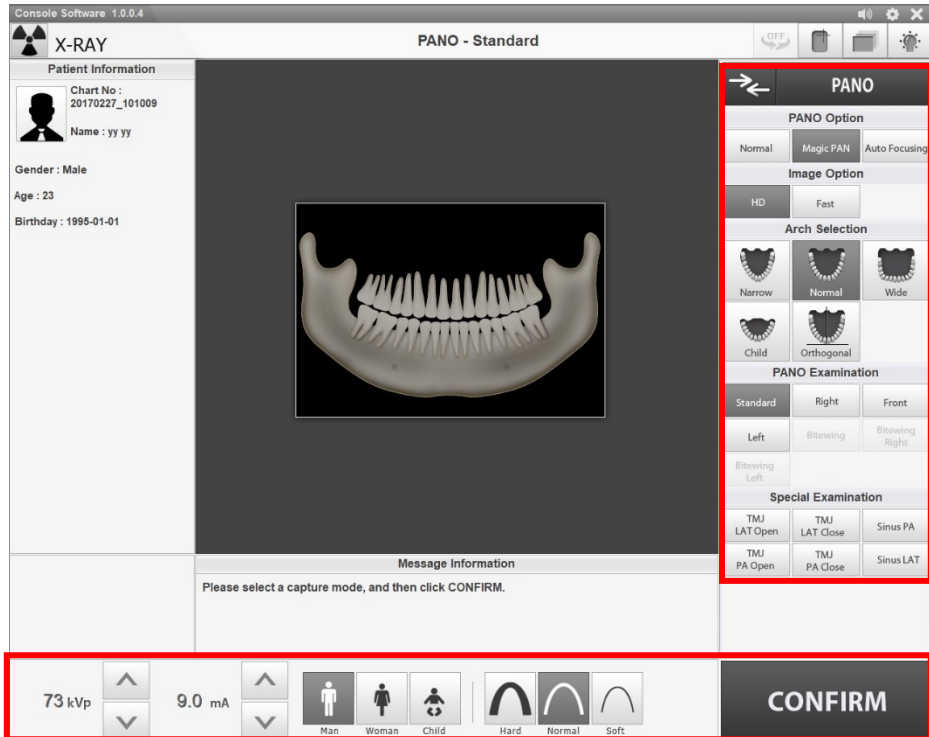

1. Click the PANO button in the Modality Option of the Main Screen.



NOTICE

The **“CEPH”** button exists only when each imaging program is included in the equipment.

2. Select a Pano Option.

PaX-i Plus



PaX-i Insight



Mode	Description
Normal (Default)	<ul style="list-style-type: none"> Provides a normal panoramic image.
Auto-Focusing (Optional)	<ul style="list-style-type: none"> Selectively provides specific multiple panoramic images having different focal planes.
Insight PAN (FOR PaX-i Insight Only)	<ul style="list-style-type: none"> Provides multiple panoramic images having different focal planes along with a normal panoramic image together. Enables detailed verification of image's in-depth direction.

3. Select an Image Option.

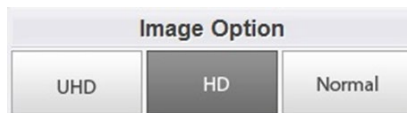

Mode	Description
UHD (Optional)	Ultra-High Definition image
HD (Default)	High Definition image
Normal	Normal quality image

NOTICE

When "Insight PAN" is selected with **PaX-i Insight**, Image Options are disabled.

4. Make an Arch Selection.



Arch Selection	Description
Narrow	A panoramic image of V-shaped palatal arches (a small number of adult females)
Normal	A panoramic image of normal adult palatal arches
Wide	A Panoramic image of square-shaped palatal arches (some number of adult males)
Child	A panoramic image of child palatal arches, approximately more than 40% less X-ray dose than in Normal mode.
Orthogonal	A panoramic image where the x-ray angle enters vertically in between the teeth so overlapping images are minimized.

NOTICE If Orthogonal Arch is selected, Bitewing examinations (Bitewing, Bitewing Incisor (Optional), Bitewing Right, Bitewing Left) are activated.

5. Select an Examination Program in the Pano Examination or Special Examination panel.



NOTICE

- To activate Bitewing examination options - Bitewing, Bitewing Incisor (Optional), Bitewing Right, Bitewing Left, select Orthogonal Arch in the Arch Selection panel.



- When a Special Examination option is clicked, the "PANO Examination" panel is disabled. If you want to select a PANO Examination option, please conduct Arch selection again.
- For more information about the Examination Program, refer to the **7.1 PANO Imaging Program Overview**.

- The Gender / Age group of the patient is selected automatically based on the patient information. If necessary, you can select the option manually.



NOTICE

Gender / Age Group		VATECH's Standard
Child		2 ~ 12 years of age
Adult	Man	> 12 years of age
	Woman	

- Select X-ray intensity.



Depending on the circumference of the patient's head, X-ray intensity may be classified as Hard, Normal, or Soft:

Soft ≤ Normal ≤ Hard

NOTICE

Age Group	Average Head Circumference (cm)	Range (cm)	X-ray Intensity
Child	53±3	>53±3	Hard
		53±3	Normal
		<53±3	Soft
Adult	56±3	>56±3	Hard
		56±3	Normal
		<56±3	Soft

8. The values of tube voltage and current are configured automatically according to the patient's gender/age group and X-ray intensity. Click the **UP/DOWN** arrow to adjust kVp and mA. The dose is adjustable by ± 1 kVp and ± 1 mA respectively.



9. Click the **CONFIRM** button when the exposure parameter setting is completed.

CONFIRM

When you click **CONFIRM** button,

- The Rotating Unit will move to its scanning position.
- The **READY** button will be activated. (This means that the equipment is ready for X-ray exposure.)
- Three Laser Beams (Vertical Beam, Horizontal Beam, and Canine Teeth Beam) will be activated.
 - The Laser Beams are turned off automatically after 20 minutes or when the **READY** button is clicked.
- The DAP (Dose Area Product), Scan Time, and Exposure Time will be displayed below the Patient Information window.

NOTICE



DAP
127.334307 mGy x cm²

Scan-time
13.5 Sec

Exposure-time
13.5 Sec

10. Guide the patient to the equipment.

7.3 Patient Positioning

	<ul style="list-style-type: none"> ▪ Have patience (especially pregnant women and children) wear a lead apron to protect themselves from residual radiation. ▪ Be careful not to shine the laser beam directly into the person's eyes. Doing so may result in vision loss.
	<ul style="list-style-type: none"> ▪ Correct posture reduces the shadow cast by the patient's cervical spine and allows clear image acquisition. ▪ Metal implants or bridges may reduce the quality of the images. ▪ Be sure to adjust the laser beam correctly. Otherwise, the quality of images can be lower due to ghost images or expansion/reduction of the images.

Getting prepared

1. Let the patient remove all the metal objects (glasses, earrings, hairpins, braces, false teeth, etc.). Metal objects may induce ghost images and lower image quality.
2. Have the patient wear a lead apron to protect themselves from residual radiation.
3. Use the **Column UP/DOWN** button or switch option to adjust the equipment to match the height of the patient.
4. Press the **Rotation test** button in the Console program and check that the equipment touches a part of the patient while the equipment is running.

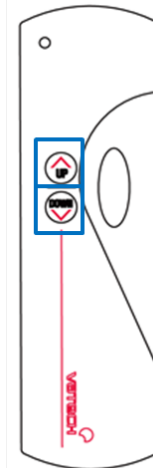

NOTICE

- In general, imaging is performed with the patient in an upright position. However, a stool may be used for imaging patients with special circumstances. If a stool is used, ensure that the beams and movement of the unit are not obstructed by the stool.

7.3.1 PANO Examination Mode (Standard / Right / Left / Front / Orthogonal)

Normal Patient Positioning

1. Insert the Normal Bite into the Normal Chinrest and cover it with a Sanitary Vinyl Cover.

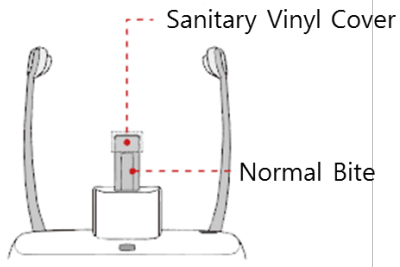

- The Sanitary Vinyl Cover is for single use only. It should be replaced for each patient. Be sure to use the approved vinyl cover.



- Clean the Chinrest and the Bite with ethanol and wipe with a dry towel before the next patient.

2. Loosen the **Temple Supports OPEN/CLOSE Wheel** under the control panel to widen the Temple Supports.

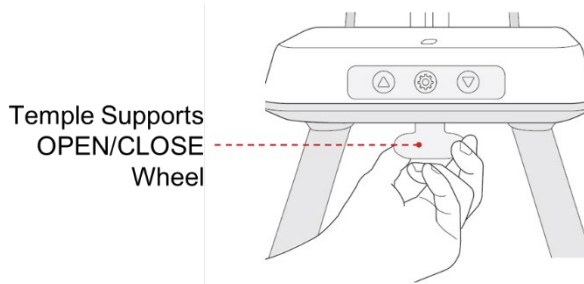

3. Guide the patient to the inside of the equipment.
4. Use the **Column UP/DOWN** button or switch option to adjust the height of the equipment so that the patient's chin reaches the Chinrest.

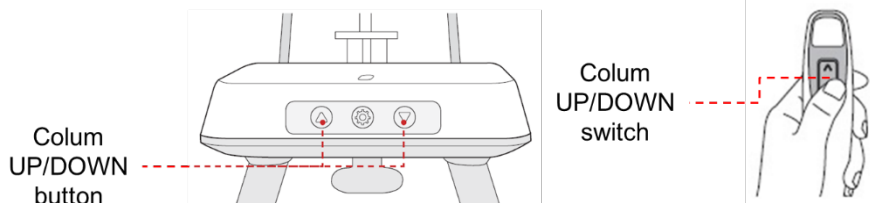

7. Acquiring PANO Images

5. Guide the patient to stand in the center of the equipment and direct them to remain in the position outlined below.
 - Hold the handles tightly.
 - Press the chest against the equipment.
 - Keep both feet close to the inside of the base.
 - Keep both shoulders parallel.
 - Straighten the Cervical Spine and stand still.
6. Let the patient bite the Bite along its grooves with his/her front teeth.

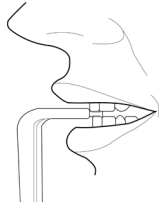

7. Let the patient maintain the posture as follows:
 - Close the mouth.
 - Place the tongue on the roof of the mouth.
 - Close eyes.

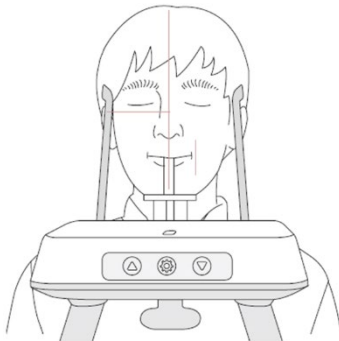

To acquire the best image possible, ask the patient not to:

- Breathe or swallow saliva during image acquisition
- Move during image acquisition

Edentulous Patient Positioning

1. Insert the **Edentulous Bite** into the **Normal Chinrest**.

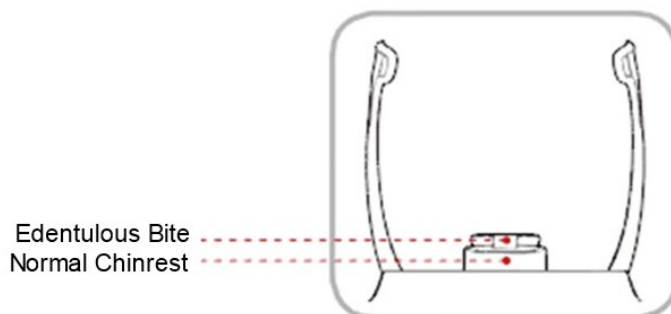

Clean the Chinrest and the Bite with ethanol and wipe with a dry towel before the next patient.

2. Loosen the **Temple Supports OPEN/CLOSE Wheel** under the control panel to widen the Temple Supports.

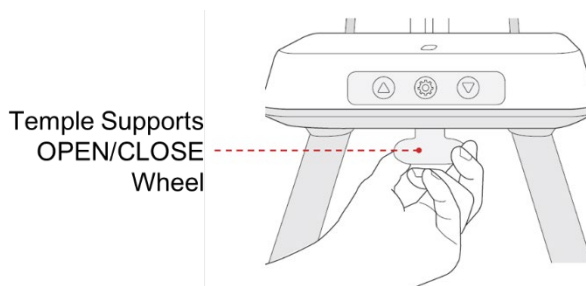

3. Guide the patient to the equipment.
4. Use the **Column UP/DOWN** button or switch option to adjust the height of the equipment so that the patient's chin reaches the Chinrest.

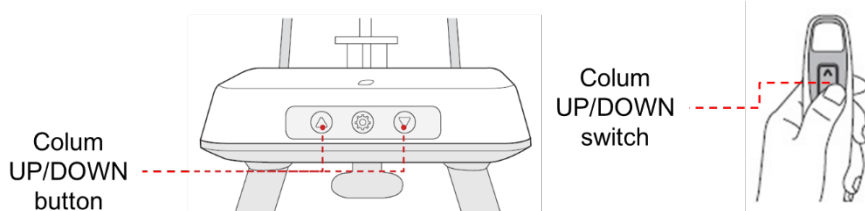

5. Guide the patient to stand in the center of the equipment and direct them to remain in the position outlined below.
 - Hold the handles tightly.
 - Press the chest against the equipment.
 - Keep both feet close to the inside of the base.
 - Keep both shoulders parallel.
 - Straighten the Cervical Spine and stand still.

6. Let the patient maintain the posture as follows:
- Close the mouth.
 - Place the tongue on the roof of the mouth.
 - Close eyes.





Laser Beam Aligning

Be careful not to shine the laser beam directly into the person's eyes. Doing so may result in vision loss.



If the laser beam is not correctly positioned, there may be distortion, causing the image to be enlarged or reduced, or ghost shadows may occur and lower the image quality. Be sure to align the laser beam properly.

NOTICE

- Three Laser Beams (Vertical Beam, Horizontal Beam, and Canine Teeth Beam) will be activated when the **CONFIRM** button is clicked.
 - The Laser Beams are turned off automatically after 20 minutes or when the **READY** button is clicked.)
- To turn the Laser beams on/off manually, click the  icon on the Control Panel of the Handle Frame or the  icon on the Console Software.

1. The Vertical Beam is fixed. Align the center of the patient's face (Mid-sagittal Line) with the Vertical Beam. (It's to prevent the horizontal expansion of the image)
2. Align the Horizontal Beam in a straight line to the Frankfurt Line on the patient's face. Use the **Horizontal Beam** lever on the column (left side of the Control Panel) to position it. Make sure that the Horizontal Beam is aligned to the patient's face horizontally.

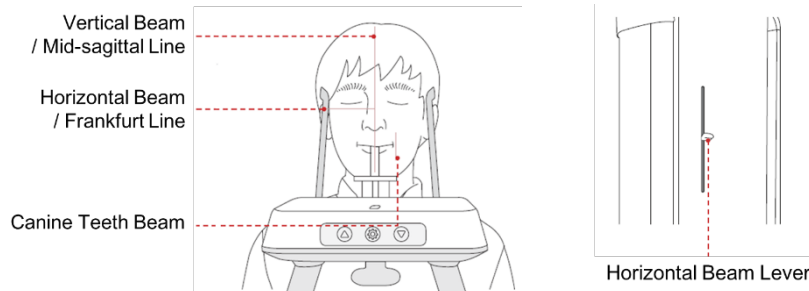

3. Direct the patient to smile and align the Canine Teeth Beam to the center of the canines. Use the Canine Teeth Beam Lever (left side of the Control Panel) to adjust the position of the beam.

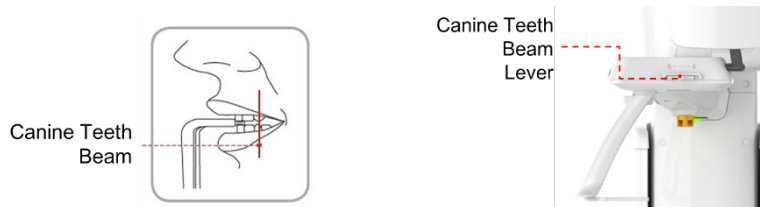

Finishing Patient Positioning

1. After checking the positions of the patient and the laser beam, tighten the **Temple Supports OPEN/CLOSE Wheel** under the control panel to prevent the patient's head from moving.

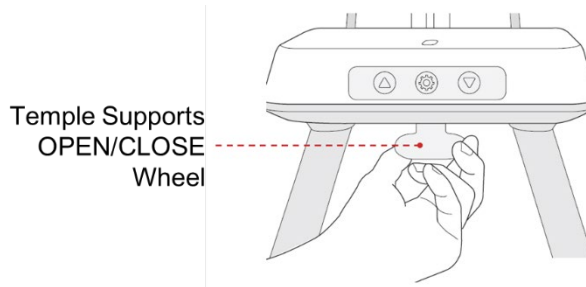

2. Click the **READY** button on the Console Software. X-ray exposure has not started yet.



Make sure that the Temple Supports are in the closed position before clicking the **READY** button.

3. Now go to **7.4 X-ray Exposure** to start the exposure.

7.3.2 SPECIAL Examination Mode (TMJ / Sinus)

7.3.2.1 TMJ Open Mode (LAT /PA)

You need to take three steps to acquire a TMJ open image: 1) positioning patient, 2) aligning laser beam and 3) X-ray exposure. You must complete the procedure for the TMJ open mode first before taking a TMJ close image.

Follow the steps below to acquire a TMJ open image.

Step 1: Positioning Patient

1. Remove the **Normal Chinrest** and Insert the **SINUS/TMJ bite** into the chinrest receptacle.

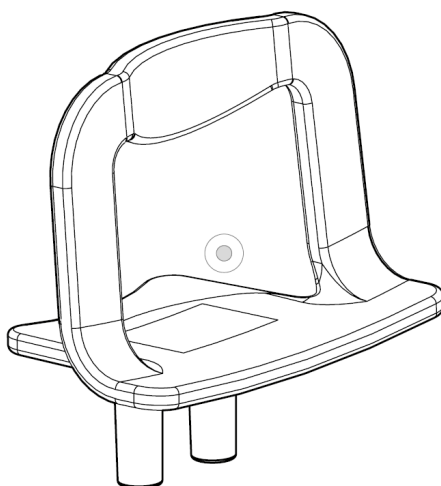

Clean the SINUS/TMJ bite with ethanol and wipe with a dry towel each time before the patient enters the equipment.

2. Turn the **Temple Support Wheel** under the control panel to open the Temple Support wide for the patient.

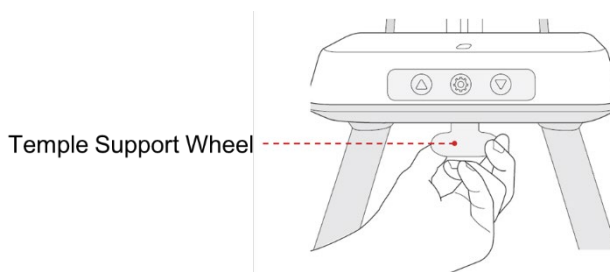

3. Guide the patient to the inside of the equipment.

7. Acquiring PANO Images

4. Press the **Column UP/DOWN** button on the control panel or switch to adjust the height of the equipment until you see the patient's chin touches on the SINUS/TMJ bite.

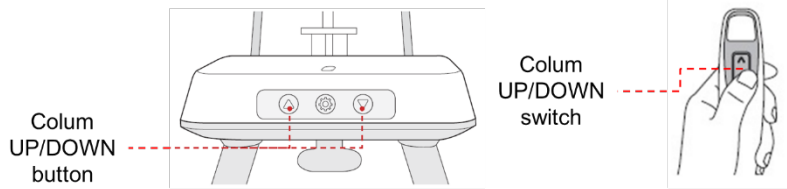

5. Ask the patient to stand in the center of the equipment and to do the following:
 - Grab the handles on both sides
 - Press the chest against the equipment
 - Place feet inside of the base.
 - Keep both shoulders parallel.
 - Stand upright and stretch the neck straight
6. Ask the patient to press the acanthion against the **SINUS/TMJ bite** and tilt the head forward by 5°.

IMPORTANT

Ensure that the patients do not touch the equipment with their jaws to maintain the proper position.

7. Ask the patient to maintain the posture as below, until the scanning is completed :
 - Keep the mouth open
 - Keep both eyes closed
 - Place the tongue on the roof of the mouth
 - Breath with the nose

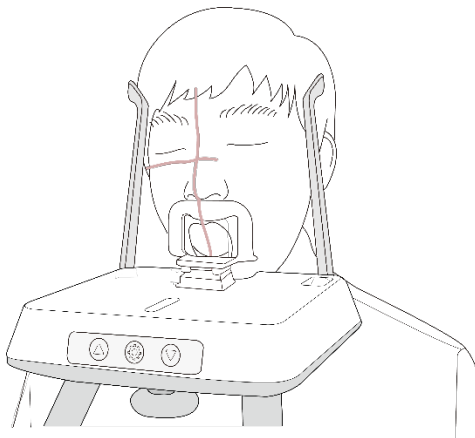



Step 2: Aligning the Laser beam

DO NOT shine the laser beam directly into the person's eyes. This can cause vision loss or other serious damages to the eyes.



Ensure that patient's position is properly aligned with laser beams before starting an X-ray exposure. Wrong positioning of a laser beam or person can create shadows or distortions in the image.



- When you click the **CONFIRM** button, three laser beams (vertical, horizontal, and canine teeth) are activated at once.
- All beams are turned off automatically after 20 minutes or when you click the **READY** button.
- If you want to turn on or off the laser beams manually, click the  icon on the Control Panel of the Handle Frame or the  icon on the Console Software.

1. The Vertical Beam is fixed. Align the center of the patient's face (Mid-sagittal Line) with the Vertical Beam. (It's to prevent the horizontal expansion of the image)
2. Align the Horizontal Beam in a straight line to the Frankfurt Line on the patient's face. Use the **Horizontal Beam** lever on the column (left side of the Control Panel) to position it. Make sure that the Horizontal Beam is aligned to the patient's face horizontally.

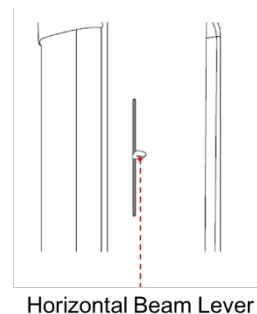
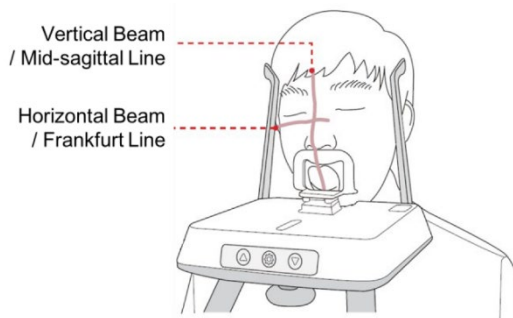

Step 3: Finishing Patient Positioning

1. After checking the positions of the patient and the laser beam, turn the Temple Support Wheel again to close temple supports to keep the patient's head from moving.

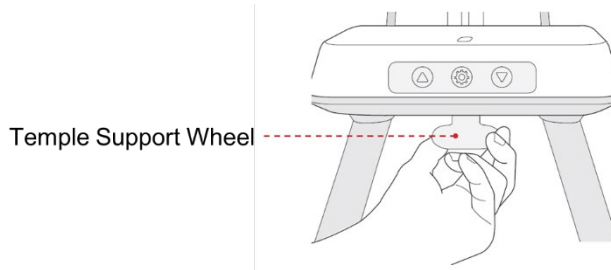

2. Click the **READY** button on the Console Software. X-ray exposure has not started yet.



Ensure that the Temple Supports are in the closed position before clicking the **READY** button.

3. Now go to **7.4 X-ray Exposure** to start the exposure.

7.3.2.2 TMJ Close Mode (LAT / PA)

When you completed the procedure for TMJ open mode, the system will be ready for the TMJ close mode. Follow the steps below to acquire a TMJ close image.

Step 1: Positioning the Patient

1. When you see the message "Do you want to capture a TMJ Close image?" Click the **OK** to start the TMJ close mode.

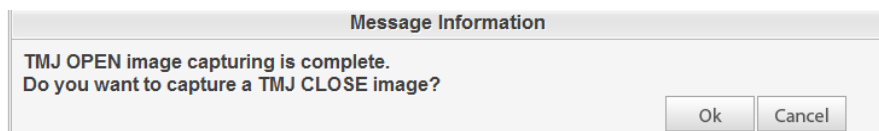

2. Turn the **Temple Support Wheel** under the control panel to open the temple support wide for the patient.
3. Guide the patient to the inside of the equipment.
4. Ask the patient to stand in the center of the equipment and to do the following:
 - Grab the handles on both sides
 - Press the chest against the equipment
 - Place feet inside of the base.
 - Keep both shoulders parallel.
 - Stand upright and stretch the neck straight
5. Ask the patient to press the acanthion against the **SINUS/TMJ bite** and tilt the head forward by 5°.

IMPORTANT

Ensure that the patient does not touch the equipment with their jaws to keep the proper position.

6. Ask the patient to maintain the posture as follows until the scanning is completed:
 - Close the mouth
 - Place the tongue on the roof of the mouth
 - Close eyes
 - Breath with nose

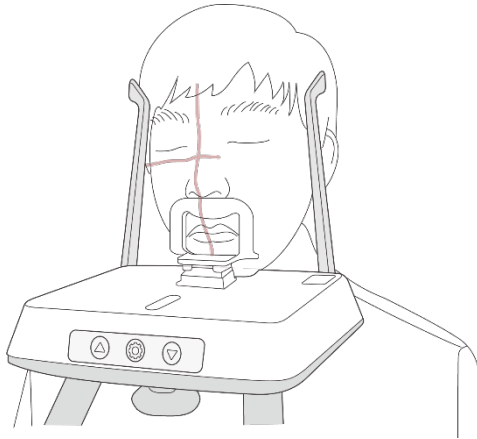

NOTICE

The support unit of the integrated Chinrest must touch the patient's acanthion.

Step 2: Aligning the Laser Beam

This is the same as the one for TMJ Open mode.

Step:3 Finishing Patient Positioning

This is the same as the one for TMJ Open mode.

7.3.2.3 Sinus Mode (LAT / PA)

Follow the steps below to acquire an image on Sinus mode.

Step 1: Positioning Patient

1. Remove the **Normal Chinrest** and Insert the **SINUS/TMJ bite**.

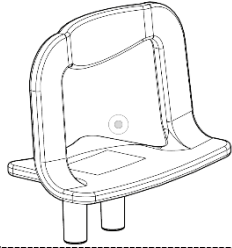

Clean the Bite with ethanol and wipe with a dry towel before the next patient.

2. Turn the **Temple Supports Wheel** under the control panel to open the Temple Supports wide for the patient.

Temple Support Wheel

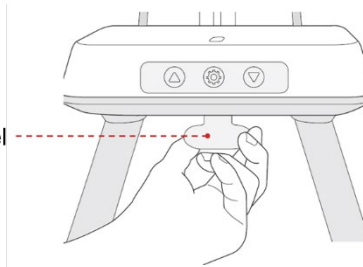

3. Guide the patient to the inside of the equipment.
4. Press the **Column UP/DOWN** button on the control panel or switch to adjust the height of the equipment until you see the patient's chin touches on the **SINUS/TMJ bite**.

Column
UP/DOWN
button

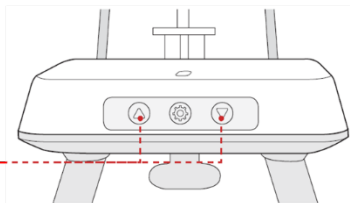

Column
UP/DOWN
switch



7. Acquiring PANO Images

5. Guide the patient to stand in the center of the equipment and direct them to remain in the position outlined below.
 - Grab the handles on both sides
 - Press the chest against the equipment
 - Place feet inside of the base
 - Keep both shoulders parallel
 - Stand upright and stretch the neck straight
6. Guide the patient to press the acanthion against the SINUS/TMJ bite and tilt the head backward about $10^{\circ} \sim 15^{\circ}$.
7. Ask the patient to maintain the posture as below until the scanning is completed :
 - Close the mouth
 - Place the tongue on the roof of the mouth
 - Close eyes
 - Breath with nose and stop swallowing

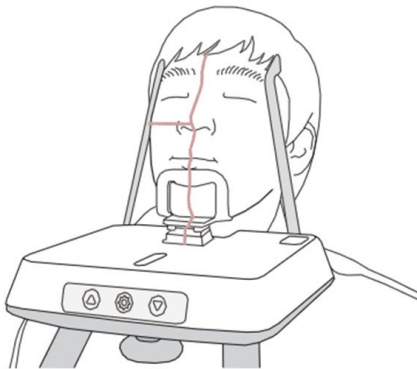

Step 2: Aligning the Laser Beam

Be careful not to shine the laser beam directly into the person's eyes. Doing so may result in vision loss.



If the laser beam is not correctly positioned, there may be distortion, causing the image to be enlarged or reduced, or ghost shadows may occur and lower the image quality. Be sure to align the Laser Beam properly.

1. The Vertical Beam is fixed. Align the center of the patient's face (Mid-sagittal Line) with the Vertical Beam. (It's to prevent the horizontal expansion of the image)
2. Align the Horizontal Beam in a straight line to the Frankfurt Line on the patient's face. Use the **Horizontal Beam** lever on the column (left side of the Control Panel) to position it. Make sure that the Horizontal Beam is aligned to the patient's face horizontally.

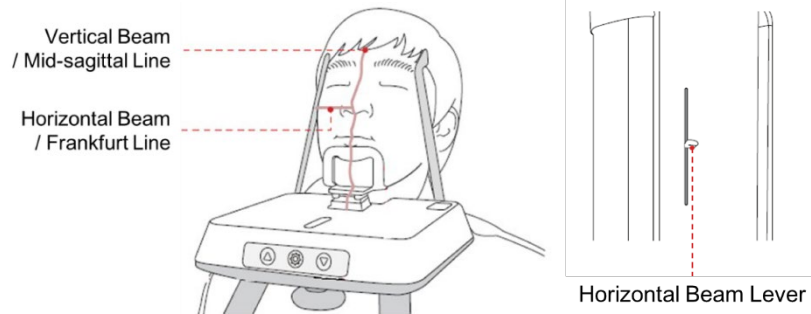
**Step 3: Finishing Patient Positioning**

1. After confirming that both patients and laser beams are properly positioned, turn the **Temple Support Wheel** to close the part to keep the patient's head from moving.

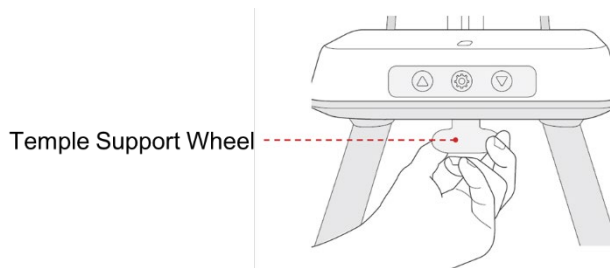

2. Click the **READY** button on the Console Software. X-ray exposure has not started yet.



Make sure that the Temple Supports are in the closed position before clicking the **READY** button.

3. Now go to **7.4 X-ray Exposure** to start the exposure.

7.4 X-ray Exposure



- If an emergency occurs during image acquisition, release the **Exposure Switch** to cease X-ray emission.
- The operator shall observe the X-ray safety regulations applicable to his/her area always during the operation of this equipment.



- The operator must keep vocal/visual contact with the patient always during the image acquisition process.
- Do not operate the PC during exposure. Doing so may cause the system to malfunction.

IMPORTANT

- Ask patients to close their eyes during the operation.
- To acquire optimized images, instruct the patient to hold his/her breath and not to swallow. Also, don't let the patient move until the Temple Supports are open.

1. Get out of the X-ray room and close the door.
2. Press and hold down the **Exposure Switch** until image acquisition is completed.

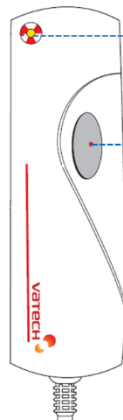

X-ray Exposure Indicator

- Green: Standby (X-ray Off)
- Yellow: In Operation (X-ray On)

Exposure Switch

NOTICE

The image appears on the screen.

NOTICE

During X-ray exposure, the status appears as follows.

- The X-ray Exposure Indicator of the Exposure Switch and the LED light on the top of the equipment turn yellow.
- An alert sound comes out to indicate that X-ray emission is currently underway.
- On Console Software, the radiation mark turns yellow, and “X-RAY” changes to “X-RAY ON”.



3. Release the **Exposure Switch** when the “Image capturing is completed” message appears on the screen.

7.5 Finishing the Scan

1. Open the Temple Supports and guide the patient out of the equipment.
2. For Normal Bite, remove the Sanitary Vinyl Cover from the Bite.
3. Press the **READY** button on the Console Software to bring the Rotating Unit back to its initial position.

7.6 Checking the Captured Images

Acquired images can be reconstructed and converted to DICOM format. The exported images can be confirmed in **EzDent-i / EasyDent**.

NOTICE

- Refer to the **EzDent-i / EasyDent** User Manual for more information.
- Please note that **EzDent-i** supports both **PaX-i Plus** and **PaX-i Insight** while **EasyDent** supports **PaX-i Plus** only.

1. The images are transferred to **EzDent-i / EasyDent** automatically.
2. The images are automatically saved if the automatic save option is configured as default. If it is not configured as default, click the **Save** button to save the images.
3. To check the image, double-click the one on the **Patient List**.

8. Acquiring CEPH Images (Optional)

8.1 CEPH Imaging Program Overview

■ Result Images



It provides conventional 2D cephalometric images.



■ Image Acquisition Method

It acquires multiple images by scanning the specific oral & maxillofacial regions with the linear movement of the narrow detector and reconstructs them to a single 2D image through computer calculations.

■ Examination Programs

It is classified as below based on the ROI (Region of Interest).

Examination Area	Description	Position
Lateral / Full Lateral	<ul style="list-style-type: none"> Used to study craniofacial disease, trauma, and congenital malformation and examine the soft tissue in the otorhinolaryngological area, the sinus, and the hard palate. Measures the angles formed by the connecting lines between the cranial measurement points to further assess the growth of the facial region. It's widely used in Orthodontics and Oral and Maxillofacial Surgery. 	 <p><Lateral></p>  <p><Full Lateral></p>
PA	<ul style="list-style-type: none"> The radiation is directed from the posterior of the skull to the anterior. Used to examine cranial diseases, trauma, and congenital malformations. Used to assess the growth of the lateral side of the face. It is also used to examine the ramus mandibulae, the posterior region of the third-largest molar in the lower jaw, the sidewall of the maxillary sinus, the frontal sinus, antrum ethmoidale, olfactory pits, and optic disc pits. Measures the angles formed by the connecting lines between the cranial measurement points to further assess the growth of the facial region. It is widely used in Orthodontics and Oral and Maxillofacial Surgery. 	 <p><PA></p>

Examination Area	Description	Position
SMV	<ul style="list-style-type: none"> Used to study the base of the skull, horizontal angulation of the mandibular condylar axis, the sphenoid sinus, the curvature of the lower jaw, the side wall of the maxillary sinus, and zygomatic arch fractures. Also used to study the inner and outer alar plates and holes at the base of the skull. 	 <p data-bbox="1071 510 1142 533"><SMV></p>
Waters' view	<ul style="list-style-type: none"> Used to study the frontal sinus, the antrum ethmoidale, the optic disc pit, the frontozygomatic suture, the nasal cavity, the coronoid process between the upper jaw and the zygomatic arch. 	 <p data-bbox="1034 765 1179 788"><Waters' view></p>
Carpus	<ul style="list-style-type: none"> Used to assess hand bone age to compare the changes in the skull. 	 <p data-bbox="1057 981 1156 1004"><Carpus></p>

8.2 Configuring Exposure Parameters

To acquire CEPH images, **6. Getting Started** must be completed first.

NOTICE

You can set the imaging parameters on the Console Software running on the PC. They are synchronized and display the same environmental settings.

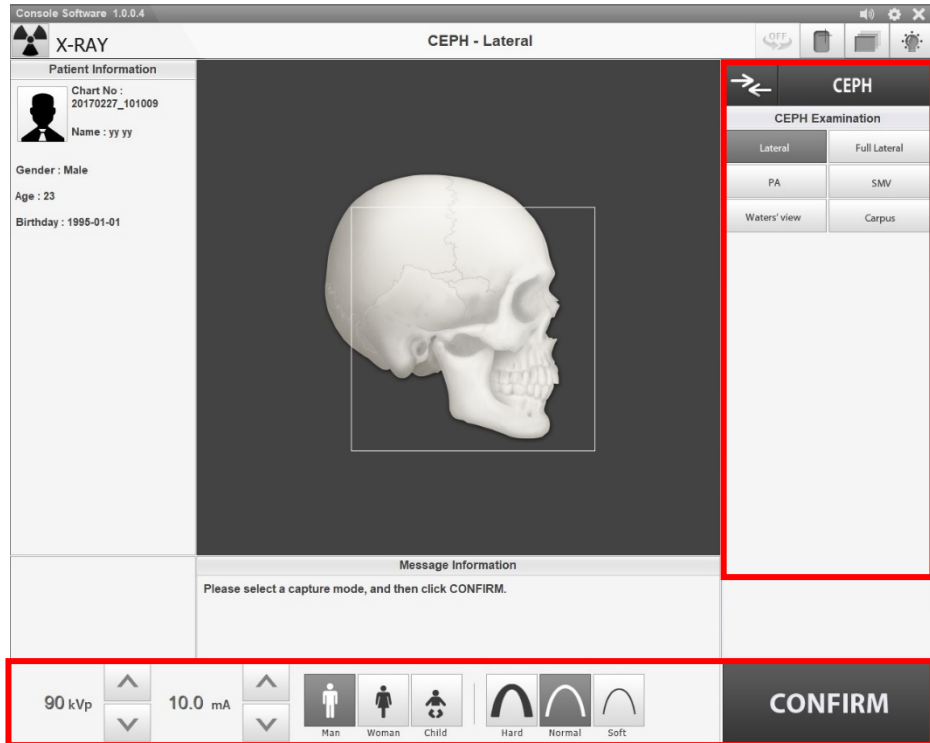

1. Click the **CEPH** button on the Main Screen.

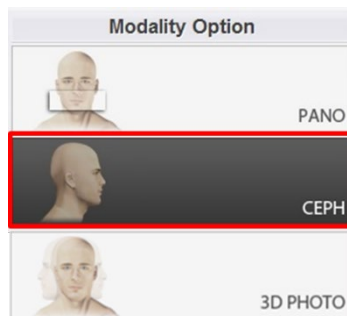

NOTICE

The “**CEPH**” button exists only when each imaging program is included in the equipment.

2. Select an Image Option.

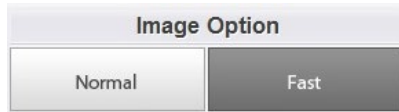

Mode	Description
Normal	Normal quality image
Fast (Default)	Low dose image

3. Select an examination program in the CEPH Examination panel.

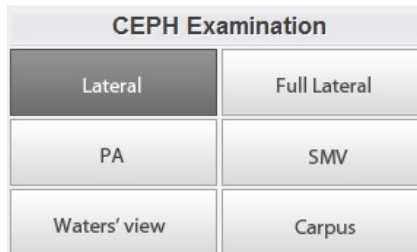

4. The Gender / Age group of the patient is selected automatically based on the patient information. If necessary, you can select the option manually.



NOTICE

Gender / Age Group		VATECH's Standard
Child		2 ~ 12 years of age
Adult	Man	> 12 years of age
	Woman	

5. Select X-ray intensity.



8. Acquiring CEPH Images (Optional)

NOTICE

Depending on the circumference of the patient's head, X-ray intensity may be classified as Hard, Normal, or Soft:

Soft ≤ Normal ≤ Hard

Age Group	Average Head Circumference (cm)	Range (cm)	X-ray Intensity
Child	53±3	>53±3	Hard
		53±3	Normal
		<53±3	Soft
Adult	56±3	>56±3	Hard
		56±3	Normal
		<56±3	Soft

- The values of tube voltage and current are configured automatically according to the patient's gender/age group and X-ray intensity. Click the **UP/DOWN** arrow to adjust kVp and mA. The dose is adjustable by ±1 kVp and ±1 mA respectively.



- Click the **CONFIRM** button when the exposure parameter setting is completed.

CONFIRM

NOTICE

When you click **CONFIRM** button,

- The **READY** button will be activated. (This means that the equipment is ready for X-ray exposure.)
- The DAP (Dose Area Product), Scan Time, and Exposure Time will be displayed below the Patient Information window.



DAP
127.334307 mGy x cm²

Scan-time
13.5 Sec

Exposure-time
13.5 Sec

- Guide the patient to the equipment.

8.3 Patient Positioning

	<ul style="list-style-type: none"> Have patience (especially pregnant women and children) wear a lead apron to protect themselves from residual radiation. Be careful not to shine the laser beam directly into the person's eyes. Doing so may result in vision loss.
	<p>Ensure that the Nasal Positioner is left unfolded, before adjusting the Ear Rods in the proper direction.</p>
	<ul style="list-style-type: none"> Correct posture reduces the shadow cast by the patient's cervical spine and allows clear image acquisition. Metal implants or bridges may reduce the quality of the images.

Getting prepared

- Let the patient remove all the metal objects (glasses, earrings, hairpins, braces, false teeth, etc.). Metal objects may induce ghost images and lower image quality.
- Have the patient wear a lead apron to protect themselves from residual radiation.
- Use the **Column UP/DOWN** button or switch option to adjust the equipment to match the height of the patient.

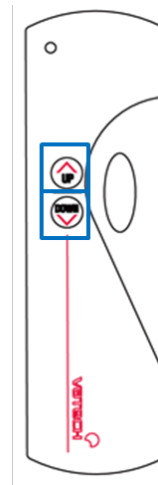
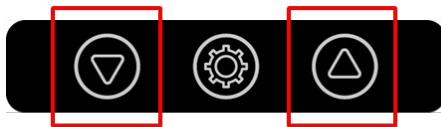

	<ul style="list-style-type: none"> In general, imaging is performed with the patient in an upright position. However, a stool may be used for imaging patients with special circumstances. If a stool is used, ensure that the beams and movement of the unit are not obstructed by the stool.
---	---

8.3.1 Lateral / Full Lateral Mode

NOTICE

Correct posture reduces the shadow cast by the patient's cervical spine and allows clear image acquisition.

Patient Positioning

1. Turn the Nasal Positioner to the **Lateral** mode Positioning Marker as shown below.



2. Leave enough space between the Ear Rods.

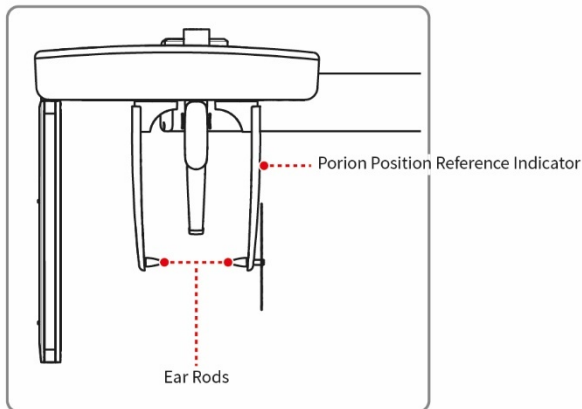

NOTICE

Use the Porion Position Reference Indicator that appears in the acquired image to easily confirm the location of Porion.

3. Guide the patient to the CEPH unit.
4. Direct the patient to relax his/her neck and shoulders and stand upright.
5. Use the **Column UP/DOWN** button or switch option to adjust the height of the CEPH unit to approximately match the height of the patient.

WARNING

After adjusting the height of the column, align the Ear Rods and Nasal Positioner to the patient.

- Align the Ear Rods to the patient's ears properly so that the head does not move during the operation. And align the Nasal Positioner to the patient's nasion by adjusting its height.

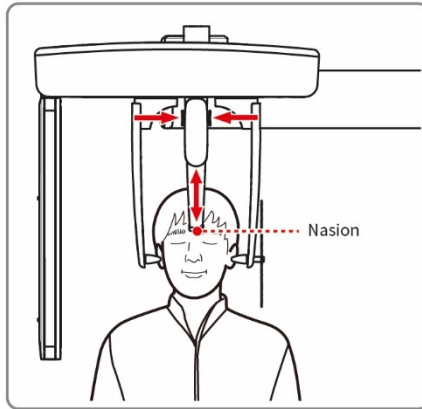

- Align horizontally so the patient's Frankfurt Line is parallel to the floor.

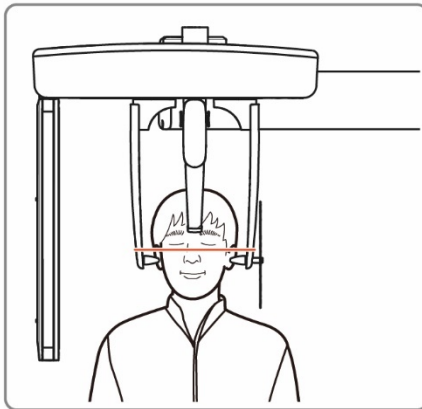

- Direct the patient to swallow first before closing the mouth and to remain in his/her current position until image acquisition is completed.
- Click the **READY** button on Console Software. No X-ray will be emitted at this point.
- Now go to **8.4 X-ray Exposure** to start the exposure.

8.3.2 PA Mode

Patient Positioning

1. Turn the Nasal Positioner to the **PA / Waters' view / Carpus** mode Positioning Marker as shown below.



2. Fold the Nasal Positioner up. The Nasal Positioner is not used in PA mode.
3. Guide the patient to the CEPH unit.
4. Ask the patient to stand upright facing the sensor. Make sure that the patient's shoulders are parallel and that his/her neck is relaxed.

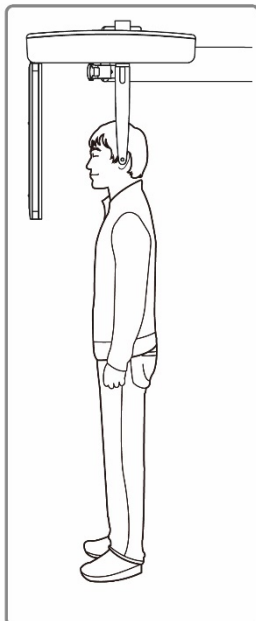

- Use the **Column UP/DOWN** button or switch option to adjust the height of the CEPH unit to approximately match the height of the patient.

**WARNING**

After adjusting the height of the column, align the Ear Rods to the patient.

- During the operation, properly align the Ear Rods to the patient's ears so his/her head does not move.
- Align horizontally so the patient's Frankfurt Line is parallel to the floor.

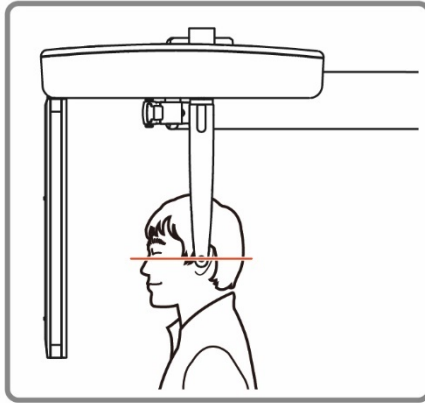

- Direct the patient to swallow first before closing his/her mouth and to remain in his/her current position until image acquisition is completed.
- Click the **READY** button on Console Software. No X-ray will be emitted at this point.
- Now go to **8.4 X-ray Exposure** to start the exposure.

8.3.3 SMV Mode

Patient Positioning

1. Turn the Nasal Positioner to the **SMV** mode Positioning Marker as shown below.



2. Fold the Nasal Positioner up. The Nasal Positioner is not used in SMV mode.
3. Guide the patient to the CEPH unit.
4. Guide the patient to face the X-ray tube and stand upright.

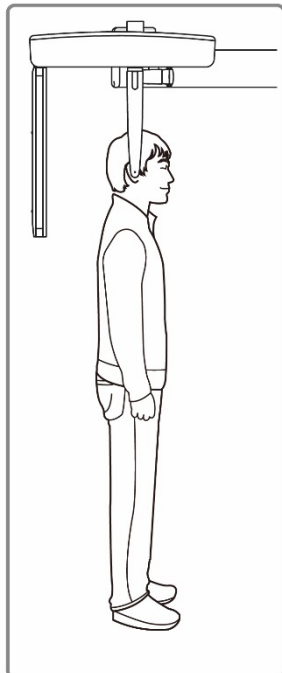

5. Use the **Column UP/DOWN** button or switch option to adjust the height of the CEPH unit to approximately match the height of the patient.

**WARNING**

After adjusting the height of the column, align the Ear Rods to the patient.

6. During the operation, properly align the Ear Rods to the patient's ears so his/her head does not move.
7. Carefully tilt the patient's head back and adjust so his/her Frankfurt Line is vertical with the floor.
8. Direct the patient to swallow first before closing his/her mouth and to remain in his/her current position until image acquisition is completed.

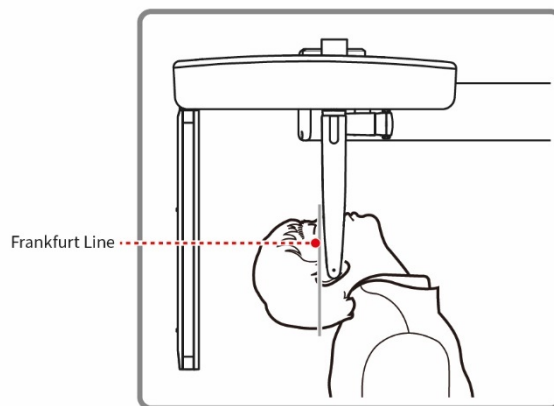

9. Click the **READY** button on Console Software. No X-ray will be emitted at this point.
10. Now go to **8.4 X-ray Exposure** to start the exposure.

8.3.4 Waters' view Mode

Patient Positioning

1. Turn the Nasal Positioner to the **PA / Waters' view / Carpus** mode Positioning Marker as shown below.



2. Fold the Nasal Positioner up. The Nasal Positioner is not used in Waters' view mode.
3. Guide the patient to the CEPH unit.
4. Ask the patient to stand upright facing the sensor. Make sure that the patient's shoulders are level and that his/her neck is relaxed.
5. Use the **Column UP/DOWN** button or switch option to adjust the height of the CEPH unit to approximately match the height of the patient.



After adjusting the height of the column, align the Ear Rods to the patient.

6. During the operation, properly align the Ear Rods to the patient's ears so his/her head does not move.
7. Direct the patient to swallow first before closing his/her mouth, and guide the patient to bend the head backward 30° - 40°. Direct the patient to remain in the current position until image acquisition is completed.

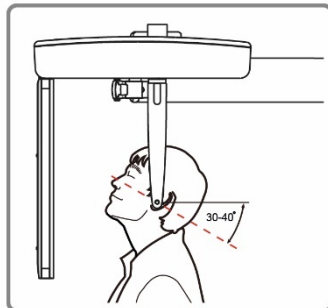

8. Click the **READY** button on Console Software. No X-ray will be emitted at this point.
9. Now go to **8.4 X-ray Exposure** to start the exposure.

8.3.5 Carpus Mode

For Carpus Mode, install the Carpus Plate first before positioning the patient.

Installing the Carpus Plate

1. Turn the Nasal Positioner to the **PA / Waters' view / Carpus** mode Positioning Marker as shown below.



2. Fold the Nasal Positioner up. The Nasal Positioner is not used in Carpus mode.
3. Fit the two ends of the Carpus Plate into the two holes of the CEPH unit as below.

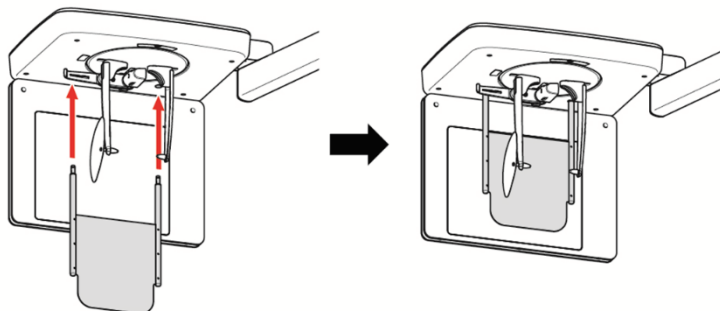

4. Confirm that the Carpus Plate is safely mounted.

Patient Positioning

1. Let the patient put his/her right hand splayed on the Carpus Plate as shown below. Make sure that the patient does not bend his/her fingers.

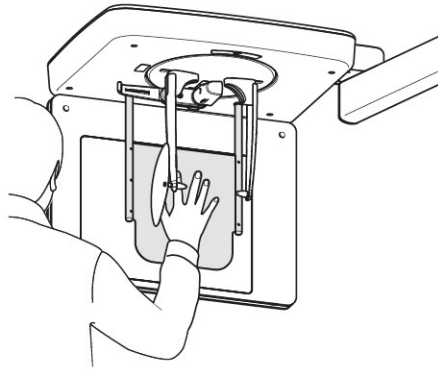

2. Ask the patient to close his/her eyes and stand still until the image acquisition is completed.
3. Click the **READY** button on Console Software. No X-ray will be emitted at this point.
4. Now go to **8.4 X-ray Exposure** to start the exposure.

8.4 X-ray Exposure



WARNING

- If an emergency occurs during image acquisition, release the **Exposure Switch** to cease X-ray emission.
- The operator shall observe the X-ray safety regulations applicable to his/her area always during the operation of this equipment.



CAUTION

- The operator must keep vocal/visual contact with the patient always during the image acquisition process.
- Do not operate the PC during exposure. Doing so may cause the system to malfunction.

IMPORTANT

- Ask the patients to close their eyes during the operation.
- To acquire optimized images, instruct the patient to hold his/her breath and not to swallow.

1. Get out of the X-ray room and close the door.
2. Press and hold down the **Exposure Switch** until image acquisition is completed.

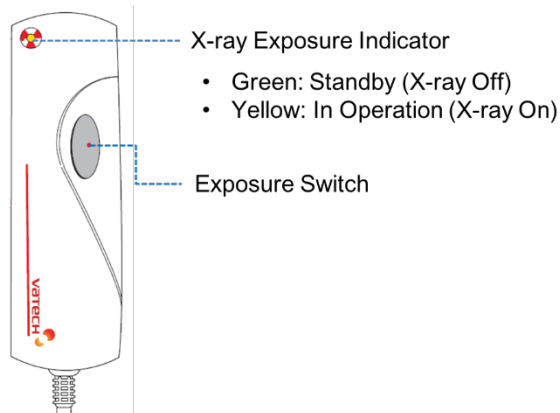

NOTICE

The image appears on the screen.

NOTICE

During X-ray exposure, the status appears as follows.

- The X-ray Exposure Indicator of the Exposure Switch and the LED light on the top of the equipment turn yellow.
- An alert sound comes out to indicate that X-ray emission is currently underway.
- On Console Software, the radiation mark turns yellow, and “X-RAY” changes to “X-RAY ON”.



X-RAY ON

3. Release the **Exposure Switch** when the “Image capturing is completed” message appears on the screen.

8.5 Finishing the Scan

1. Leave enough space between the Ear Rods.
2. Fold the Nasal Positioner up in case it's unfolded.
3. Guide the patient out of the equipment.

8.6 Checking the Captured Images

Acquired images can be reconstructed and converted to DICOM format.

The exported images can be confirmed in **EzDent-i / EasyDent**.

NOTICE

- Refer to the **EzDent-i / EasyDent** User Manual for more information.
- Please note that **EzDent-i** supports both **PaX-i Plus** and **PaX-i Insight** while **EasyDent** supports **PaX-i Plus** only.

1. The images are transferred to **EzDent-i / EasyDent** automatically.
2. The images are automatically saved if the automatic save option is configured as default. If it is not configured as default, click the **Save** button to save the images.
3. To check the image, double-click the one on the **Patient List**.

This page intentionally left blank

9. Troubleshooting

9.1 Troubleshooting

If a problem occurs while operating the equipment, perform the corresponding troubleshooting measures outlined in the table below. If the problem persists, please contact our customer support staff.

If the equipment is not working

Cause	Actions to be taken
Failure of power supply	Check the equipment's power supply.
Initialization status	Wait until the equipment has been initialized and then try again.
Failure of the Control PC's connection	Check the connection status of the Communication Port (Optic) which connects the PC to the equipment.

If the Exposure Switch is not functioning

Cause	Actions to be taken
Failure of readiness	Check whether the Console Software is ready for imaging.

If imaging cannot be performed

Cause	Actions to be taken
Failure of initialization	Wait until the equipment is initialized and then try again. If this problem persists, restart the equipment.

If the Laser Beam has shut off and patient positioning cannot be performed

Cause	Actions to be taken
Expiration of the time allotted for patient positioning	Press the Laser Beam button to turn on the Laser Beam.

9.2 Error Codes

In instances of abnormal operation, error messages will be displayed on the Control Panel. Error Code Guide is intended to assist technicians to understand and deal with error codes. Follow the instructions described in the tables below to resolve the problem.

Error messages will be displayed in the format written below.

[Code: E00X.0XX.XXX]

The code consists of three parts: Main code, Subcode, Tail Code.

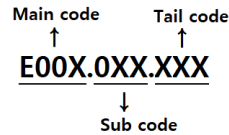

IMPORTANT

The **main code** indicates the source of error codes. The source is categorized as hardware, software, acquisition module, etc.

Subcode describes the specific area where an error has occurred according to the Main code.

Tail Code explains the detailed symptoms and causes of the errors mentioned in the subcode.

The tables of the following chapter consist of four parts: Tail Code, Description, Solution, CS Part List.

Tail Code	Description	Solution

IMPORTANT

Tail Code explains the detailed symptoms and causes of the errors mentioned in the subcode.

The description provides a brief cause of the problems according to each error code.

The solution provides instructions to solve the problem according to each error code.

It is categorized into three parts: Essential, Recommended, and Optional.

9.2.1 Hardware

9.2.1.1 Main code (001)

9.2.1.1.1 Subcode – Generator related error (001)

Tail Code	Description	Solution
001	Appears when the tube is not ready for use	<ol style="list-style-type: none"> Check the CAN communication response by sending the following command to the inverter board and the sensor to check the CAN communication operation of the Main MCU. <ul style="list-style-type: none"> Inverter board: [SPM_IVER] Sensor: [SPM_FISS_0001] If the inverter board and the sensor do not respond, replace the Main MCU. If only the inverter board does not respond, check the connection status of H002009A (Pin 10, 12) and H002022A (Pin 3, 4) cable to check CAN communication between the Main MCU and inverter board. <hr/> <div style="display: flex; align-items: center;"> <div style="background-color: #0056b3; color: white; padding: 5px; margin-right: 10px;">NOTICE</div> <div>Connection status refers to reconnection, disconnection, pin status, etc.</div> </div> <hr/> <ol style="list-style-type: none"> 1. If the cable is normal, check that 24V is normally applied to pins 1 and 2 of CN13 to check the input voltage of the drive board. 2. When 24V is normally applied to the inverter board, replace the generator. 3. If 24V is not confirmed, check the power cable H002009A (Pin 9, 10) and H002022A (Pin 1, 2) from the Main MCU to the inverter board. 3.4. If the cable is normal, see if DC 24V is normally applied to pins 1, 3 of CN100 to check the input power of the Main MCU. 3.5. If 24V is applied, replace the Main MCU. 3.6. If 24V is not applied, replace the power board.
002	Appears when the cable between the tube tank and Inverter board are disconnected	<ol style="list-style-type: none"> Check the connection of the high voltage cable between the inverter board and the tube tank. If the same problem occurs after cable replacement, replace the generator. <hr/> <div style="display: flex; align-items: center;"> <div style="background-color: #0056b3; color: white; padding: 5px; margin-right: 10px;">NOTICE</div> <div>The generator includes a tube tank and an inverter board.</div> </div> <hr/>
003	Appears when	<ol style="list-style-type: none"> Send out the code [SPM_TEST], [SPM_IVER], and

Tail Code	Description	Solution
	the current of the inverter board exceeds the maximum allowable level during X-ray irradiation	<p>[SPM_FISS_0001] through the terminal to check the operation status and IC board component status. (Advance remote check required)</p> <ul style="list-style-type: none"> ▪ If there is a problem during operation or communication, replace the corresponding component (motor, board) and generator. ▪ If there is no problem, replace the generator. <p>2. Check the high voltage input power (power board output voltage) of the inverter board CN1 pin 1, 3 is DC 380V.</p> <p>3. When X-ray is irradiated, check whether the high voltage input power of the inverter board CN11 pin 1, 2 is 340V or more. (Normal if 340V or more)</p> <ul style="list-style-type: none"> ▪ If any problem occurs in stage 2 or 3, replace the power board. <p>4. For equipment manufactured before 2014/04/19, apply the brass bar solution.</p>
004	Appears when there is $\pm 10\text{kV}$ or more voltage difference in tube voltage compared to the reference value	<p>1. Send out the code [SPM_TEST], [SPM_IVER], and [SPM_FISS_0001] through the terminal to check the operation status and IC board component status. (Advance remote check required)</p> <ul style="list-style-type: none"> ▪ If there is a problem during operation or communication, replace the corresponding component (motor, board) and generator. ▪ If there is no problem, replace the generator. <p>2. Check the high voltage input power (power board output voltage) of the inverter board CN1 pin 1, 3 is DC 380V.</p> <p>3. When X-ray is irradiated, check whether the high voltage input power of the inverter board CN11 pin 1, 2 is 340V or more. (Normal if 340V or more)</p> <ul style="list-style-type: none"> ▪ If any problem occurs in stage 2 or 3, replace the power board. <p>4. For equipment manufactured before 2014/04/19, apply the brass bar solution.</p>
005	Appears when there is $\pm 0.5\text{mA}$ or more current difference in tube current compared to the reference value	<p>1. Send out the code [SPM_TEST], [SPM_IVER], and [SPM_FISS_0001] through the terminal to check the operation status and IC board component status. (Advance remote check required)</p> <ul style="list-style-type: none"> ▪ If there is a problem during operation or communication, replace the corresponding component (motor, board) and generator. ▪ If there is no problem, replace the generator.

Tail Code	Description	Solution
		<ol style="list-style-type: none"> 2. Check the high voltage input power (power board output voltage) of the inverter board CN1 pin 1, 3 is DC 380V. 3. When X-ray is irradiated, check whether the high voltage input power of the inverter board CN11 pin 1, 2 is 340V or more. (Normal if 340V or more) <ul style="list-style-type: none"> ▪ If any problem occurs in stage 2 or 3, replace the power board. 4. For equipment manufactured before 2014/04/19, apply the brass bar solution.
006	Appears when there is $\pm 20\text{kV}$ or more voltage difference in tube voltage feedback compared to the normal value	<ol style="list-style-type: none"> 1. Send out the code [SPM_TEST], [SPM_IVER], and [SPM_FISS_0001] through the terminal to check the operation status and IC board component status. (Advance remote check required) <ul style="list-style-type: none"> ▪ If there is a problem during operation or communication, replace the corresponding component (motor, board) and generator. ▪ If there is no problem, replace the generator. 2. Check the high voltage input power (power board output voltage) of the inverter board CN1 pin 1, 3 is DC 380V. 3. When X-ray is irradiated, check whether the high voltage input power of the inverter board CN11 pin 1, 2 is 340V or more. (Normal if 340V or more) <ul style="list-style-type: none"> ▪ If any problem occurs in stage 2 or 3, replace the power board. 4. For equipment manufactured before 2014/04/19, apply the brass bar solution.
007	Appears when there is $\pm 1\text{mA}$ or more current difference in tube current feedback compared to the normal value	<ol style="list-style-type: none"> 1. Send out the code [SPM_TEST], [SPM_IVER], and [SPM_FISS_0001] through the terminal to check the operation status and IC board component status. (Advance remote check required) <ul style="list-style-type: none"> ▪ If there is a problem during operation or communication, replace the corresponding component (motor, board) and generator. ▪ If there is no problem, replace the generator. 2. Check the high voltage input power (power board output voltage) of the inverter board CN1 pin 1, 3 is DC 380V. 3. When X-ray is irradiated, check whether the high voltage input power of the inverter board CN11 pin 1, 2 is 340V or more. (Normal if 340V or more) <ul style="list-style-type: none"> ▪ If any problem occurs in stage 2 or 3, replace

Tail Code	Description	Solution
		<p>the power board.</p> <p>4. For equipment manufactured before 2014/04/19, apply the brass bar solution.</p>
008	Appears when the temperature of the mono tank is above the setting temperature	<p>1. Check that the temperature of the mono-tank is 55°C or higher through the log message of the capture program.</p> <div style="border: 1px dashed black; padding: 5px;"> <div style="display: flex; align-items: center;"> <div style="background-color: #0056b3; color: white; padding: 2px 5px; font-weight: bold; margin-right: 5px;">NOTICE</div> <div style="border-left: 1px dashed black; padding-left: 5px;"> <p>The temperature is automatically checked every 10 seconds in the terminal program.</p> </div> </div> </div> <p>2. If the temperature is higher than 55°C, the problem has occurred from continuous shooting using the capture program. It is necessary to notify and educate the staff members that enough cooling time is required during shooting.</p> <div style="border: 1px dashed black; padding: 5px;"> <div style="display: flex; align-items: center;"> <div style="background-color: #0056b3; color: white; padding: 2px 5px; font-weight: bold; margin-right: 5px;">NOTICE</div> <div style="border-left: 1px dashed black; padding-left: 5px;"> <p>The cooling time Vatech suggests is 1:60. (60 seconds pause at the time of 1-second irradiation)</p> </div> </div> </div> <p>3. If the same problem occurs after the measurements stated above, replace the generator.</p>
009	Appears when the inverter output current is higher than 1A during X-ray irradiation (In EP, IP condition)	<p>1. Send out the code [SPM_TEST], [SPM_IVER], and [SPM_FISS_0001] through the terminal to check the operation status and IC board component status. (Advance remote check required)</p> <ul style="list-style-type: none"> ▪ If there is a problem during operation or communication, replace the corresponding component (motor, board) and generator. ▪ If there is no problem, replace the generator. <p>2. Check the high voltage input power (power board output voltage) of the inverter board CN1 pin 1, 3 is DC 380V.</p> <p>3. When X-ray is irradiated, check whether the high voltage input power of the inverter board CN11 pin 1, 2 is 340V or more. (Normal if 340V or more)</p> <ul style="list-style-type: none"> ▪ If any problem occurs in stage 2 or 3, replace the power board. <p>4. For equipment manufactured before 2014/04/19, apply the brass bar solution.</p>
010	Appears when the inverter board falsely	<p>1. Replace the exposure switch and check if the same problem occurs.</p>

Tail Code	Description	Solution
	recognizes the exposure switch signal as OFF after the irradiation On command	<ol style="list-style-type: none"> 2. Check if 24V is normally outputted from pins 5, 6 of CN3 of the power board. <ol style="list-style-type: none"> 2.1. If 24V is not applied, replace the power board. 2.2. If 24V is applied, see if 24V is outputted from pins 1, 2 of CN1201 to check the input power of the Main MCU. 2.3. If 24V is not applied, replace the Main MCU. 2.4. If 24V is applied, check the multipole cable. <p>In particular, check the connection status of the exposure switch cable H002009A (Pin 16) and H002022A (Pin 5) connected from the Main MCU board to the inverter board.</p> 3. If the problem is not resolved, replace the generator.
011	Appears when the X-ray OFF command is not sent to the inverter board in 0.5 seconds after turning off the exposure switch	<ol style="list-style-type: none"> 1. Make sure that the staff member properly presses the exposure switch during irradiation. 2. Replace the exposure switch and check if the same error occurs. 3. Check the connection status of pins 10, 12 (Main MCU) of CN1200, and pins 3, 4 of CN13 (inverter board). <div style="border: 1px dashed black; padding: 5px; margin: 10px 0;"> <div style="display: flex; align-items: center;"> <div style="background-color: #0056b3; color: white; padding: 5px 10px; font-weight: bold; font-size: 1.2em;">NOTICE</div> <div style="margin-left: 10px;"> <p>Connection status refers to reconnection, disconnection, pin status, etc.</p> </div> </div> </div> <ol style="list-style-type: none"> 4. Check the input voltage of the Main MCU and the inverter board. <ol style="list-style-type: none"> 1. Check if the input voltage of pins 5, 6 of CN600 of the Main MCU is 24V. <ul style="list-style-type: none"> ▪ If not 24V, replace the power board. 2. Check if the input voltage of pin 1, 2 of CN13 (inverter board) is 24V. <ul style="list-style-type: none"> ▪ If not 24V, replace the Main MCU. ▪ If 24V is applied normally, replace the generator.
012	Appears when kV feedback is over -20kV compared to the setting value during X-ray irradiation	<ol style="list-style-type: none"> 1. Send out the code [SPM_TEST], [SPM_I VER], and [SPM_FISS_0001] through the terminal to check the operation status and IC board component status. (Advance remote check required) <ul style="list-style-type: none"> ▪ If there is a problem during operation or communication, replace the corresponding component (motor, board) and generator. ▪ If there is no problem, replace the generator.

Tail Code	Description	Solution
		<ol style="list-style-type: none"> 2. Check the high voltage input power (power board output voltage) of the inverter board CN1 pin 1, 3 is DC 380V. 3. When X-ray is irradiated, check whether the high voltage input power of the inverter board CN11 pin 1, 2 is 340V or more. (Normal if 340V or more) <ul style="list-style-type: none"> ▪ If any problem occurs in stage 2 or 3, replace the power board. 4. For equipment manufactured before 2014/04/19, apply the brass bar solution.
013	Appears when kV feedback is over +20kV compared to the setting value during X-ray irradiation	<ol style="list-style-type: none"> 1. Send out the code [SPM_TEST], [SPM_IVER], and [SPM_FISS_0001] through the terminal to check the operation status and IC board component status. (Advance remote check required) <ul style="list-style-type: none"> ▪ If there is a problem during operation or communication, replace the corresponding component (motor, board) and generator. ▪ If there is no problem, replace the generator. 2. Check the high voltage input power (power board output voltage) of the inverter board CN1 pin 1, 3 is DC 380V. 3. When X-ray is irradiated, check whether the high voltage input power of the inverter board CN11 pin 1, 2 is 340V or more. (Normal if 340V or more) <ul style="list-style-type: none"> ▪ If any problem occurs in stage 2 or 3, replace the power board. 4. For equipment manufactured before 2014/04/19, apply the brass bar solution.
014	Appears when the mA feedback value is less than 50% compared to setting condition during X-ray irradiation	<ol style="list-style-type: none"> 1. Send out the code [SPM_TEST], [SPM_IVER], and [SPM_FISS_0001] through the terminal to check the operation status and IC board component status. (Advance remote check required) <ul style="list-style-type: none"> ▪ If there is a problem during operation or communication, replace the corresponding component (motor, board) and generator. ▪ If there is no problem, replace the generator. 2. Check the high voltage input power (power board output voltage) of the inverter board CN1 pin 1, 3 is DC 380V. 3. When X-ray is irradiated, check whether the high voltage input power of the inverter board CN11 pin 1, 2 is 340V or more. (Normal if 340V or more) <ul style="list-style-type: none"> ▪ If any problem occurs in stage 2 or 3, replace

Tail Code	Description	Solution
		<p>the power board.</p> <p>4. For equipment manufactured before 2014/04/19, apply the brass bar solution.</p>
015	Appears when the mA feedback value is higher than 150% compared to setting condition during X-ray irradiation	<p>1. Send out the code [SPM_TEST], [SPM_IVER], and [SPM_FISS_0001] through the terminal to check the operation status and IC board component status. (Advance remote check required)</p> <ul style="list-style-type: none"> ▪ If there is a problem during operation or communication, replace the corresponding component (motor, board) and generator. ▪ If there is no problem, replace the generator. <p>2. Check the high voltage input power (power board output voltage) of the inverter board CN1 pin 1, 3 is DC 380V.</p> <p>3. When X-ray is irradiated, check whether the high voltage input power of the inverter board CN11 pin 1, 2 is 340V or more. (Normal if 340V or more)</p> <ul style="list-style-type: none"> ▪ If any problem occurs in stage 2 or 3, replace the power board. <p>4. For equipment manufactured before 2014/04/19, apply the brass bar solution.</p>

9.2.1.1.2 Subcode - Motor related error (002)

Tail Code	Description	Solution
020	Appears during p-axis motor origin movement	<p>1. Check the operation status due to mechanical load.</p> <div style="border: 1px dashed black; padding: 5px;"> <p style="text-align: center;">NOTICE</p> <p>Operation status includes motor operation, a foreign substance in the axis, the existence of the mechanical load, timing belt, etc.</p> </div> <p>2. Check if the photosensor LED of the p-axis motor and the XORG LED of the Main MCU lights up. Also, check if 24V is outputted from pins 1, 3 of CN1209.</p> <ul style="list-style-type: none"> ▪ If there is a problem, replace the photosensor. <p>3. If the p-axis motor operates normally, increase the torque value of the p-axis motor.</p> <div style="border: 1px dashed black; padding: 5px;"> <p style="text-align: center;">NOTICE</p> <p>Back up the torque value by [SPM_XMRT] and apply the torque value as 2000 higher than the current value.</p> </div>

Tail Code	Description	Solution
		<p>4. Check the cable connection of the p-axis motor.</p> <p>NOTICE</p> <p>Connection status refers to reconnection, disconnection, pin status, etc.</p> <p>5. Check the p-axis motor for defects and replace the motor if a problem occurs.</p> <p>5.1. Make sure the resistance between pins 1, 3, and pins 2, 4 is $2\Omega \pm 10\%$.</p> <p>5.2. Check if there is a short between pins 1, 4, and pins 2, 3.</p> <p>6. If the problem is not resolved, replace the Main MCU.</p>
021	Appears during rotator-axis motor origin movement	<p>1. Check the operation status due to mechanical load.</p> <p>NOTICE</p> <p>Operation status includes motor operation, a foreign substance in the axis, existence of the mechanical load, timing belt, etc.</p> <p>2. Check if the photosensor LED of the rotator-axis motor and the RORG LED of the Main MCU lights up. Also, check if 24V is outputted from pins 5, 6 of CN102.</p> <ul style="list-style-type: none"> ▪ If there is a problem, replace the photosensor. <p>3. If the rotator-axis motor operates normally, increase the torque value of the rotator-axis motor.</p> <p>NOTICE</p> <p>Back up the torque value by [SPM_RMRT] and apply the torque value as 2000 higher than the current value.</p> <p>4. Check the cable connection of the rotator-axis motor.</p> <p>NOTICE</p> <p>Connection status refers to reconnection, disconnection, pin status, etc.</p> <p>5. Check the rotator-axis motor for defects and replace the motor if a problem occurs.</p> <p>1. Make sure the resistance between pins 1, 3, and pins 2, 4 is $1.1 \sim 1.3 \Omega$.</p> <ul style="list-style-type: none"> ▪ Check if there is a short between pins 1, 4, and pins 2, 3. <p>6. If the problem is not resolved, replace the Main MCU.</p>

Tail Code	Description	Solution
027	Appears during Cephalo sensor motor origin movement	<ol style="list-style-type: none"> Check the operation status due to mechanical load. <div style="border: 1px dashed black; padding: 5px; margin-top: 10px;"> <div style="background-color: #0056b3; color: white; padding: 2px 5px; display: inline-block;">NOTICE</div> <p>Operation status includes motor operation, a foreign substance in the axis, existence of the mechanical load, timing belt, etc.</p> </div> <ul style="list-style-type: none"> ▪ If there is a problem, replace the photosensor. Check if the LED of the cephalo sensor motor and the CSOR LED of the Main MCU lights up. Also, check if 24V is outputted from pins 1, 3 of CN302. <ul style="list-style-type: none"> ▪ If there is a problem, replace the photosensor. Increase the torque value of the cephalo sensor motor. <div style="border: 1px dashed black; padding: 5px; margin-top: 10px;"> <div style="background-color: #0056b3; color: white; padding: 2px 5px; display: inline-block;">NOTICE</div> <p>Back up the torque value by [SPM_HMRT] and apply the torque value as 2000 higher than the current value.</p> </div> Check the cable connection of the cephalo sensor axis motor. <div style="border: 1px dashed black; padding: 5px; margin-top: 10px;"> <div style="background-color: #0056b3; color: white; padding: 2px 5px; display: inline-block;">NOTICE</div> <p>Connection status refers to reconnection, disconnection, pin status, etc.</p> </div> Check the cephalo sensor axis motor for defects and replace the motor if a problem occurs. <ol style="list-style-type: none"> 5.1. Make sure that the resistance between pins 1, 3, and pins 2, 4 is $5.8\Omega \pm 10\%$. 5.2. Check if there is a short between pins 1, 4, and pins 2, 3. If the problem is not resolved, replace the Main MCU.
036	Appears during mono-axis collimator left/right origin movement	<ol style="list-style-type: none"> If the problem is not resolved, check the operation status due to mechanical load. <div style="border: 1px dashed black; padding: 5px; margin-top: 10px;"> <div style="background-color: #0056b3; color: white; padding: 2px 5px; display: inline-block;">NOTICE</div> <p>Operation status includes motor operation, a foreign substance in the axis, existence of the mechanical load, timing belt, etc.</p> </div> Check if CORG LED of the Main MCU and the photosensor LED of the left/right axis motor of the mono-axis calibrator light up. Also, check if 24V is outputted from pins 14, 18 of CN106. If there are no problems, replace the collimator

Tail Code	Description	Solution
037	Appears during generator tilting	<p>assembly.</p> <ol style="list-style-type: none"> 1. Make sure the product is a Ceph model. If it is not a Ceph model, check whether [SPM_CISC], [SPM_TITY] is activated. 2. If the output is normal, check the operation status due to mechanical load. <hr/> <div style="display: flex; justify-content: space-between;"> <div style="border: 1px solid black; padding: 2px; background-color: #0056b3; color: white; font-weight: bold; font-size: 1.2em;">NOTICE</div> <div> <p>Operation status includes motor operation, a foreign substance in the axis, existence of the mechanical load, timing belt, etc.</p> </div> </div> <hr/> <ul style="list-style-type: none"> ▪ After sending the [SPM_TICE] command, check if the generator is tilting in Ceph mode and the limit switch is detected. After confirmation, send [SPM_TIFR] to stop the motor drive. <hr/> <div style="display: flex; justify-content: space-between;"> <div style="border: 1px solid black; padding: 2px; background-color: #0056b3; color: white; font-weight: bold; font-size: 1.2em;">NOTICE</div> <div> <p>Check whether the motor stops and the GT02 LED of the Main MCU lights up.</p> </div> </div> <hr/> <ul style="list-style-type: none"> ▪ After sending the [SPM_TIPA] command, check whether the generator is tilting in the PANO/CT mode and the limit switch is detected. After confirmation, send [SPM_TIFR] to stop the motor drive. <ol style="list-style-type: none"> 3. If the limit switch is not recognized normally, replace the Main MCU. 4. If the tilting motor does not operate normally, check the tilting motor for defects. 7. 4.1. If the tiling motor is normal, please replace the Main MCU.
039	Appears during X-axis motor origin movement	<ol style="list-style-type: none"> 1. Check the operation status due to mechanical load. <hr/> <div style="display: flex; justify-content: space-between;"> <div style="border: 1px solid black; padding: 2px; background-color: #0056b3; color: white; font-weight: bold; font-size: 1.2em;">NOTICE</div> <div> <p>Operation status includes motor operation, a foreign substance in the axis, the existence of the mechanical load, timing belt, etc.</p> </div> </div> <hr/> <ol style="list-style-type: none"> 2. Check if the LED of the x-axis motor and the XORG LED of the Main MCU lights up. Also, check if 24V is outputted from pins 1, 3 of CN1209. <ul style="list-style-type: none"> ▪ If there is a problem, replace the photosensor. 3. If the x-axis motor operates normally, increase the torque value of the x-axis motor.

Tail Code	Description	Solution
		<p>NOTICE</p> <p>Back up the torque value by [SPM_HMRT] and apply the torque value as 2000 higher than the current value.</p> <p>4. Check the cable connection of the x-axis motor.</p> <p>NOTICE</p> <p>Connection status refers to reconnection, disconnection, pin status, etc.</p> <p>5. Check the x-axis motor for defects and replace the motor if a problem occurs.</p> <p>5.1. Make sure the resistance between pins 1, 3, and pins 2, 4 is $2\Omega \pm 10\%$.</p> <p>5.2. Check if there is a short between pins 1, 4, and pins 2, 3.</p> <p>6. If the problem is not resolved, replace the Main MCU.</p>

9.2.1.1.3 Subcode – Exposure switch related error (003)

Tail Code	Description	Solution
060	Appears if the exposure switch is pressed when turning on the equipment.	<p>1. To check whether the exposure switch operates normally or not, conduct the following measurement.</p> <p>1.1. Remove the exposure switch and see if the same problem occurs.</p> <p>1.2. Replace the current exposure switch with the spare switch provided</p> <ul style="list-style-type: none"> ▪ Replace the exposure switch if the problem occurs after conducting the measurements mentioned above. <p>2. Check the status of the extension cable.</p> <p>NOTICE</p> <p>Connection status refers to short-circuited, disconnection, etc.</p> <p>3. If there is no problem in stages 1 and 2, replace the Main MCU.</p>

9.2.1.1.4 Subcode – Other error (004)

Tail Code	Description	Solution
102	Appears when there is no response during CAN	<p>1. Check the CAN communication response by sending the following command to the inverter board and sensor to check the CAN communication operation of the Main MCU. (Advance remote check required)</p>

Tail Code	Description	Solution
	communication	<ul style="list-style-type: none"> ▪ Inverter board: [SPM_IVER] ▪ Sensor: [SPM_FISS_0001] <ol style="list-style-type: none"> 2. If both the inverter board and sensor do not respond, replace the Main MCU. 3. If only the inverter board does not respond, check the connection status of H002009A (pin 10, 12) and H002022A (pin 3, 4) cable to check CAN communication between the Main MCU and Inverter board. <hr/> <div style="display: flex; align-items: center;"> <div style="border: 1px solid black; background-color: #0056b3; color: white; padding: 5px; margin-right: 10px;">NOTICE</div> <div>Connection status refers to reconnection, disconnection, pin status, etc.</div> </div> <hr/> <ol style="list-style-type: none"> 3.1. If the cable is normal, check that 24V is normally applied to pins 1, 2 of CN13 to check the input voltage of the drive board. 3.2. When the 24V power supply is normal, replace the inverter board. 3.3. If 24V power is not confirmed, check the power cable H002009A (pin 9, 10) and H002022A (pin 1, 2) from the Main MCU to the inverter board. 3.4. If the cable is normal, check if pins 1, 3 of CN100 are applied 24V to check the input power of the Main MCU. 3.5. If 24V is applied, replace the Main MCU. 3.6. If 24V is not applied, replace the power board. 4. If only the sensor does not respond, check the connection status of the H002009A (pin 9, 13) and H002043A (pin 1, 2) cable to check CAN communication between the Main MCU and the sensor. <hr/> <div style="display: flex; align-items: center;"> <div style="border: 1px solid black; background-color: #0056b3; color: white; padding: 5px; margin-right: 10px;">NOTICE</div> <div>Connection status refers to reconnection, disconnection, pin status, etc.</div> </div> <hr/> <ol style="list-style-type: none"> 4.1. If the cable is normal, check that 8V is normally applied to pins 1, 3 of CN104 to check the input voltage of the sensor. 4.2. When the 8V power supply is normal, replace the sensor board. 4.3. If 8V power is not confirmed, check the power cable H002009A (Pin 2, 3) and H002042A (Pin 1, 3) from the Main MCU to the sensor. 4.4. If the cable is normal, check if 24V is applied to pin 1, 3 of CN100 to check the input power of the Main MCU. 4.5. If 24V is applied, replace the Main MCU.

Tail Code	Description	Solution
		4.6. If 24V is not applied, replace the power board.

9.2.2 Software

9.2.2.1 Main code (002)

9.2.2.1.1 Subcode – Sequence related error (001)

Tail Code	Description	Solution
001	Appears when the Packing Mode is not enabled	<ol style="list-style-type: none"> 1. Check the equipment is in the Packing Mode. 2. If the equipment is in the Packing Mode, unlock the mode by sending [SMP_PKEN_0000].
002	Appears when the door is open	<ol style="list-style-type: none"> 1. Check whether the door is open. 2. Check if the activation of the DoorLock function in the capturing SW and the firmware of the main MCU. 3. Check the [SPM_DROP_000x] value by sending [SPM_ISDR] through serial communication. (0 : Deactivated, 1 : Activated) 4. Check the door sensor. 5. If the problem is not resolved, contact the customer service team for further information.
003	Appears when the exposure switch is pressed	<ol style="list-style-type: none"> 1. To check whether the exposure switch operates normally or not, conduct the following measurement. <ol style="list-style-type: none"> 1.1. Remove the exposure switch and see if the same problem occurs. 1.2. Replace the current exposure switch with the spare switch provided <ul style="list-style-type: none"> ▪ Replace the exposure switch if the problem occurs after conducting the measurements mentioned above. 2. Check the status of the extension cable. <div style="border: 1px dashed black; padding: 5px; margin-top: 10px;"> <div style="display: flex; align-items: center;"> <div style="background-color: #0056b3; color: white; padding: 5px 10px; font-weight: bold; font-size: 1.2em;">NOTICE</div> <div style="margin-left: 10px; border-left: 1px dashed black; padding-left: 10px;"> Connection status refers to short-circuited, disconnection, etc. </div> </div> </div> 3. If there is no problem in stages 1 and 2, replace the Main MCU.

9.2.2.1.2 Subcode – PC Resolution related error (010)

Tail Code	Description	Solution
001	Appears when the	<ol style="list-style-type: none"> 1. Check whether the resolution setting is

Tail Code	Description	Solution
	resolution is less than 1280x1024	1280x1024 or higher than 1280x1024. 2. Check whether the magnification of the resolution is 100%.
002	Appears when the resolution is less than 1200x960	1. Check whether the resolution setting is 1200x960 or higher than 1200x1024. 2. Check whether the magnification of the resolution is 100%.

9.2.2.1.3 Subcode – PC Network related error (02X)

Tail Code	Description	Solution
N/A (0XX)	Appears when there is a problem related to the PC Network connection	<ol style="list-style-type: none"> 1. Check whether the power of the equipment is on when the capture SW is running. 2. Check whether the other communication programs are running. 3. Check the communication port setting of the Capture SW and the Device Manager. 4. Check the communication cable connection status. <div style="border: 1px dashed black; padding: 5px; margin: 10px 0;"> <div style="display: flex; align-items: center;"> <div style="background-color: #0056b3; color: white; padding: 2px 10px; font-weight: bold; font-size: 1.2em;">NOTICE</div> <div style="margin-left: 10px;"> <p>Connection status refers to reconnection, bending, contamination, etc.</p> </div> </div> </div> <ol style="list-style-type: none"> 5. Reconnect or replace the Grabber Card. 6. If the same problem occurs, replace the Main MCU.

9.2.2.1.4 Subcode – PC Network related error (03X)

Tail Code	Description	Solution
N/A (0XX)	Appears when there is a library-related error	<ol style="list-style-type: none"> 1. Set Administrator Permission by checking problematic files in the Log. 2. If the problem is not resolved, replace the Environment.ini file with Manufacture data. 3. If the problem is not resolved, reinstall the Capture Software.

9.2.2.1.5 Subcode – File related error (06X)

Tail Code	Description	Solution
N/A (0XX)	Appears when the Patient.ini file cannot be found	<ol style="list-style-type: none"> 1. Check the Patient.ini file location setting. 2. If the file location setting is normal, replace the file with the same file copied from the equipment manufactured data.

9.2.3 Acquisition Module

9.2.3.1 Main code (003)

9.2.3.1.1 Subcode – Initialization Failure related error (010)

Tail Code	Description	Solution
000	Appears when the COM port cannot be opened	<ol style="list-style-type: none"> 1. Check whether the driver of the grabber and virtual comport is recognized in the device manager. (Advance remote check is required.) 2. Reinstall the driver to the latest version. (Advance remote check is required.) 3. Move the grabber to another PC slot and check if there is a problem. 4. If the problem is not resolved, replace the grabber. 5. If the same problem occurs after replacing the grabber, replace the PC.
001	Appears when the frame grabber interface cannot be initialized or memory for acquisition cannot be reserved	<ol style="list-style-type: none"> 1. Check whether the driver of the grabber is recognized in the device manager. (Advance remote check is required.) 2. Reinstall the driver to the latest version. (Advance remote check is required.) 3. Check the PC specification and the Windows & Bios setting. (Advance remote check is required.) 4. Move the grabber to another PC slot and check if the problem occurs. 5. If the problem is not resolved, replace the grabber. 6. If the same problem occurs after replacing the grabber, replace the PC.
002	Appears when the MCU is not communicable or the modem ring signal is in an improper state	<ol style="list-style-type: none"> 1. Check whether the communication is available with the Main MCU. 2. If there is a problem, replace or reconnect the optic cable. 3. Replace the Main MCU.

9.2.3.1.2 Subcode – Capture Failure related error (020)

Tail Code	Description	Solution
000	Appears when there is a capture error	<ol style="list-style-type: none"> 1. Check the Windows & Bios setting. (Advance remote check is required.) 2. Check the grabber card. (Advance remote check is required.) <div style="border: 1px dashed black; padding: 5px; margin-top: 10px;"> <div style="display: flex; align-items: center;"> <div style="background-color: #0056b3; color: white; padding: 5px 10px; font-weight: bold; font-size: 1.2em;">NOTICE</div> <div style="margin-left: 10px;"> <p>Check whether the device manager and grabber driver are recognizable.</p> <p>Check the FPGA version and</p> </div> </div> </div>

Tail Code	Description	Solution
		<p>conduct the pattern test.</p> <ol style="list-style-type: none"> 3. Check whether the Dark is secured. (Advance remote check is required.) 4. If there is no problem, check whether 5V is applied to the sensor. 5. Connect the sensor and the PC Grabber with the optic cable to confirm whether the image data can be acquired. 5.1. If the equipment operates normally, check the optic cable and optic hub board for each section. <p>NOTICE section: sensor~optic hub, optic hub~column, column~PC</p> <ol style="list-style-type: none"> 6. If the problem is not resolved, replace the sensor.

9.2.3.1.3 Subcode – Reconstruction Failure related error (030)

Tail Code	Description	Solution
001	Appears when bugs exist in VXM-file or there is insufficient memory	<ol style="list-style-type: none"> 1. Check whether the graphic card is installed. 2. Check whether the capturing PC satisfies the required PC specification (CPU, RAM, GPU). 3. If the PC specification is normal, upgrade the graphic card driver to the latest version. 4. If the problem is not resolved, replace the graphic card.

9.2.3.1.4 Subcode – Hardware related error (061)

Tail Code	Description	Solution
HW Error No	Appears when the error occurs during acquisition module operation	Follow the instructions stated in the hardware error code section according to the code number, e.g. E003.061.001 = E001.001.001.

10. Cleaning and Disinfection



The liquid can cause damage to the equipment. When cleaning or disinfecting, liquids may enter the equipment or the release button via the ventilation slots.

- Do not spray the equipment with Cleaners or disinfectant agents. Apply the Cleaners or disinfectant agents to a clean cloth and wipe it.
- Make sure that no liquids run along the surface into the ventilation slots or release button.
- Remove any soiling with a soft, wet, lint-free cloth.
- Please follow the Cleaners or disinfectant agents' instructions for use.
- When cleaning or disinfect the surfaces, always disconnect the equipment from the mains.
- Do not use spray cleaner or disinfectant directly onto the equipment, as this could cause a fire.

IMPORTANT

The equipment must be installed and maintained on a flat surface.

NOTICE

The equipment must be installed and maintained on a flat surface.

- Cleaners or disinfectant agents may contain powerful ingredients. Unsuitable cleaning and disinfectant agents are detrimental to health and attack the surface of the equipment.
- Do not use cleaners or disinfectant agents containing Phenol, acetic acid, peroxide, other oxygen splitting agents, sodium hypochlorite, and isopropyl alcohol (2-propanol, isopropanol) or iodine-splitting agents.
- Comply with the specifications contained in the operating instructions of the Cleaners or disinfectant agents.
- Wear safety gloves.

10.1 Cleaning



Always turn off the power to the equipment and disconnect it from the power outlet before cleaning.

- Thoroughly clean the areas of the equipment that come in direct contact with the patient, such as the Chinrest and the Bite.
- Do not use spray cleaners or solvents as they could flow into the equipment and damage the electrical components or cause a fire.
- Do not use abrasive liquids such as acetone, gas, or oil, which may cause corrosion on the surface of the equipment.
- Do not use any cleaning products which contain silicon. They could potentially damage the equipment's electrical components.

The following table summarizes the standard cleaning procedures to be performed by the operator.

Components	Cleaning Process
Bite (Normal Bite, SINUS/TMJ bite, and Edentulous Bite)	Clean with ethanol and gently wipe with a dry towel before the next patient.
Temple Supports	Clean with ethanol and gently wipe with a dry towel before the next patient.
Chinrest	Clean with ethanol and gently wipe with a dry towel before the next patient.
Computer and peripherals	Follow the manufacturers' instructions found in the accompanying manuals.
Outer covers of equipment	Wipe the unit with a dry cloth at the end of each day.

IMPORTANT

Do not use cleaning agents in aerosol or spray form directly on the surface of the equipment.

10.2 Disinfection

- Use only disinfectants that comply with the respective national regulatory body's valid requirements or whose bactericidal, fungicidal, and virucidal properties have been verifiably tested and approved accordingly.
- Sterilization and disinfection should be performed thoroughly for items that have been in frequent contact with patients and operators.
- Do not use UV systems to disinfect the equipment, as exposed parts of the equipment can turn yellow or discolor.
- The use of unsuitable Cleaners or disinfectant agents and methods can damage the equipment and accessories. Only use the Cleaners or disinfectant agents specified or approved by VATECH
- The following Cleaners or disinfectant agents have been evaluated for safe use on the surfaces.
- Never combine products or liquids other than the products listed above.
- Damages to surfaces and materials due to different products cannot be excluded even if they are not included in the exceptions mentioned above.
- Use a non-alcoholic chlorine dioxide-based disinfectant.



Fig 1. Disinfectant Sample

This page intentionally left blank

11. Maintenance

VATECH requires periodic constancy tests to ensure image quality and the safety of the patient and the operator.

Only **VATECH**-authorized technicians can perform inspection and service for the equipment. For technical assistance, contact the **VATECH** service center or your local **VATECH** representative.

11.1 Regular Maintenance



- Always turn off the equipment before performing any maintenance.
- Do not remove equipment covers. There are no repairable parts inside.
- The only parts that can be replaced by the user are the input fuses, which must comply with the manufacturer's specifications.
- As a precaution against fire, the replacement should be one in the same type and range.

IMPORTANT

- There are no user-serviceable parts inside this equipment.
- If any service is required, please contact the **VATECH** service center or your local **VATECH** representative.

- Do not unplug cables by force.
- Do not expose the equipment or components in an area that is susceptible to water or humidity.
- Do not expose the equipment in an area of extreme fluctuation in temperature, poor ventilation, direct sunlight, dust, salt, et cetera.
- Keep all detachable components well organized and clean.
- Make sure that the equipment is well-grounded.
- Do not try to modify this equipment, including the wires or cables. Doing so may damage it beyond repair.

11.2 Maintenance Task Checklist

Tasks	Period
Before the operation, ensure that the equipment is clean and ready for use. Make sure that all parts that come in direct contact with the patient have been cleaned thoroughly.	Daily
After using the equipment, make sure that the Main Power Switch has been turned off.	Daily
Ensure that the equipment is firmly plugged into a dedicated power source.	Daily
Ensure that the plug and the power cord are not heated abnormally.	Daily
Confirm that the LED indicator turns yellow when the Exposure Switch is pressed. Ensure that the LED indicator remains yellow for the entire duration of the exposure.	Daily
Ensure that the power cable is not kinked, broken, exposed, and free of all other defects.	Daily
Confirm that activating the Emergency Stop Switch ceases the unit's operation. Pressing the Emergency Stop Switch should stop all movement of the equipment and X-ray emission.	Weekly
Ensure that all visible labels are intact and legible.	Weekly
Check for possible damages to the Exposure Switch cable.	Monthly
Confirm that the audio message is audible throughout the duration of the exposure.	Monthly

12. Disposing of the Equipment

To reduce environmental contamination, this equipment is designed to be as safe as possible to use and dispose of. Many components of this equipment, except for some like the X-ray tube, are environment-friendly and can be recycled.

All parts and components which contain hazardous materials must be disposed of by disposal regulations (IEC 60601-1 6.8.2 j).

Parts	Materials	Recyclable	To the special disposal site	Hazardous waste; Needs Separate Collection
Frame and Covers	Aluminum and plastics	•		
Motors		•		
Circuit Boards		•		
Cables and Transformer	Copper	•		
	Steel	•		
	Oil		•	
Packing	Wood	•		
	Cardboard	•		
	Paper	•		
X-ray Tube				•
Sensor Head	Return the Sensor Head to VATECH			
Other parts			•	



This dental equipment shall not be disposed of as domestic garbage materials.

IMPORTANT

Clean / Disinfect / Sterilize the equipment before disassembling it and disposing of its parts.

NOTICE

Observe all regulations relevant to the disposal of waste in your country.

This page intentionally left blank

13. Technical Specifications

13.1 Mechanical Specifications

13.1.1 Dimensions (unit = mm)

	With CEPH Unit	Without CEPH Unit
With Base		

Without Base

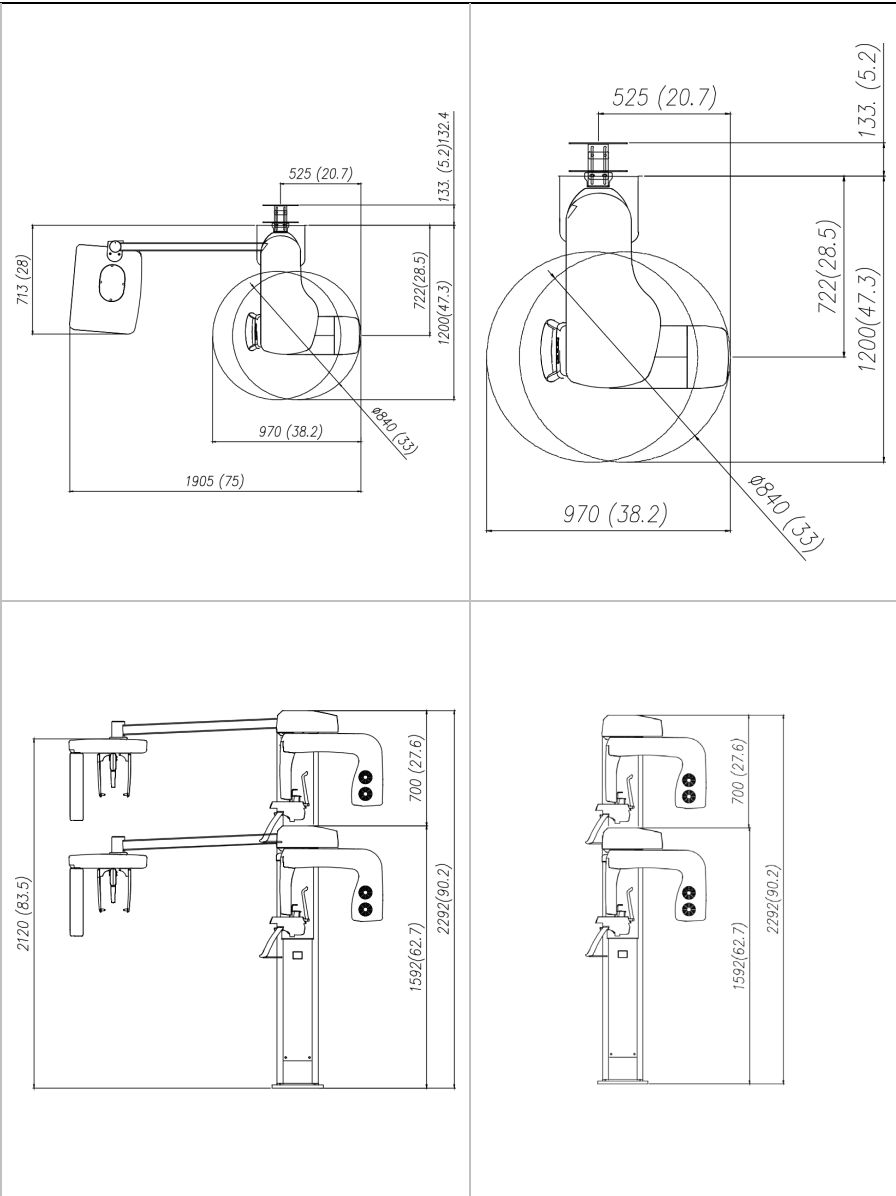

Item		Description
Weight	Without CEPH unit	95 kg (209.4 lbs. – without Base)
		135 kg (297.6 lbs. – with Base)
	With CEPH unit	120 kg (264.5 lbs. - without Base)
		160 kg (352.7 lbs. - with Base)
Total Height	Without Base	Max. 2292 mm
	With Base	Max. 2320 mm
Dimensions during operation (Length x Width x Height)	Without CEPH unit	970 mm (L) x 1333 mm (W) x 2292 mm (H) (without Base)
		990 mm (L) x 1333 mm (W) x 2320 mm (H) (with Base)
	With CEPH unit	1905 mm (L) x 1333 mm (W) x 2292 mm (H) (without Base)
		1905 mm (L) x 1333 mm (W) x 2320 mm (H) (with Base)
Rotating Unit Vertical Movement		Max. 700mm
Installation type		Base Stand / Wall Mount (Default: Wall Mount type)
Packing Box Organization		Main Box, CEPH Box (Optional), Base Box (Optional)

13.1.2 Image Magnification

Mode	FDD (mm)	FOD (mm)	ODD (mm)	Magnification
PANO	490.3	375.5	114.6	1 : 1.3
CEPH	1745	1524	221	1 : 1.14

- **FDD:** Focal Spot to Detector Distance
- **FOD:** Focal Spot to Object Distance
- **ODD:** Object to Detector Distance (ODD = FDD - FOD)
- **Magnification = FDD / FOD**

13.2 Technical Specifications

13.2.1 X-ray Generator Specifications

Specifications

Item		Description	
Generator	Model	DG-07D21T2	
	Rated output power	1.0 kW	
	Inverter model name	INV-21	
	Type	Inverter	
	Normal/ Pulse	kVp	60 kV ~ 99 kV (1 kV increment)
		mA	4 mA ~ 10 mA (1 mA increment)
	Cooling	Air Cooling / Protect $\geq 60^{\circ}\text{C}$ 1:60 or more (Exposure time: interval time)	
	Total filtration	Min. 2.5 mm Al	
Added filtration	1.5 mm Al (Fixed)		
Tube	Manufacturer	Canon Electron Tubes & Devices	
	Model	D-052SB (Stationary Anode type)	
	Focal spot size	0.5 mm x 0.5 mm (IEC 60336)	
	Target Angle	5 degrees	
	Inherent Filtration	At least 0.8 mm Al equivalent at 50 kV	
	X-ray Coverage	95 mm x 380 mm at SID 550 mm	
	Anode Heat Content	35 kJ	
	Duty Cycle	1:60 or more (Exposure time: Interval time)	

Test Condition

Mode	Tube Voltage (kVp)	Tube Current (mA)	Exposure Time (s)
PANO	60 ~ 99	4 ~ 10	20.2
	60 ~ 99	4 ~ 10	17.2
	60 ~ 99	4 ~ 10	16.7
	60 ~ 99	4 ~ 10	14.5
	60 ~ 99	4 ~ 10	13.8
	60 ~ 99	4 ~ 10	13.5
	60 ~ 99	4 ~ 10	11.5
	60 ~ 99	4 ~ 10	11.2
	60 ~ 99	4 ~ 10	11.1
	60 ~ 99	4 ~ 10	10.3
	60 ~ 99	4 ~ 10	10.1
	60 ~ 99	4 ~ 10	9.7
	60 ~ 99	4 ~ 10	9.2
	60 ~ 99	4 ~ 10	8.6
	60 ~ 99	4 ~ 10	8.4
	60 ~ 99	4 ~ 10	7.3
	60 ~ 99	4 ~ 10	7.2
	60 ~ 99	4 ~ 10	6.8
	60 ~ 99	4 ~ 10	6.7
	60 ~ 99	4 ~ 10	6.2
	60 ~ 99	4 ~ 10	6.1
	60 ~ 99	4 ~ 10	6.0
	60 ~ 99	4 ~ 10	5.9
	60 ~ 99	4 ~ 10	5.7
60 ~ 99	4 ~ 10	5.2	
60 ~ 99	4 ~ 10	5.1	
60 ~ 99	4 ~ 10	5.0	

Mode	Tube Voltage (kVp)	Tube Current (mA)	Exposure Time (s)
	60 ~ 99	4 ~ 10	4.9
	60 ~ 99	4 ~ 10	4.8
	60 ~ 99	4 ~ 10	4.3
	60 ~ 99	4 ~ 10	3.7
	60 ~ 99	4 ~ 10	3.6
	60 ~ 99	4 ~ 10	3.1
	60 ~ 99	4 ~ 10	2.6
	60 ~ 99	4 ~ 10	2.5
	60 ~ 99	4 ~ 10	1.8
	60 ~ 99	4 ~ 10	1.3
CEPH	60 ~ 99	4 ~ 10	1.9
	60 ~ 99	4 ~ 10	2.4
	60 ~ 99	4 ~ 10	3.9
	60 ~ 99	4 ~ 10	4.9
	60 ~ 99	4 ~ 10	5.4

Maximum Rating Charts

Constant potential high-voltage generator
Nominal Focus Spot Value: 0.5

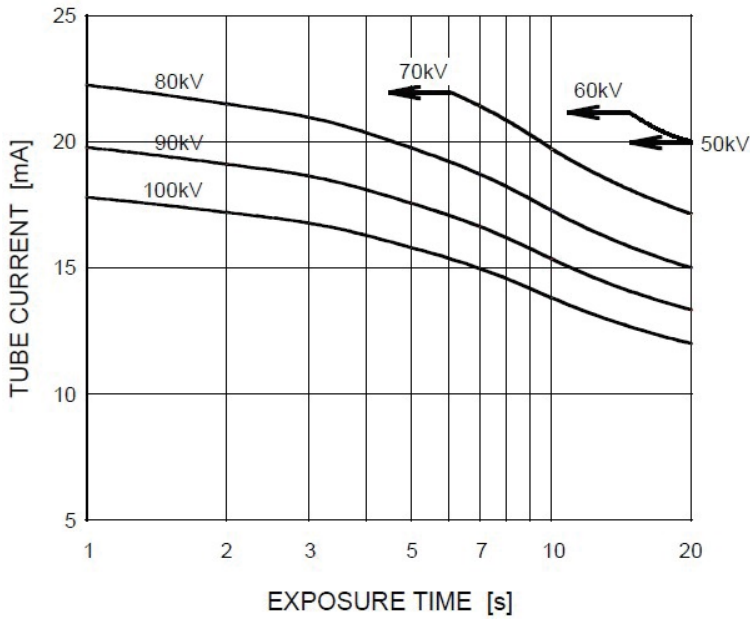

Emission & Filament Characteristics

Constant potential high-voltage generator
Nominal Focus Spot Value: 0.5

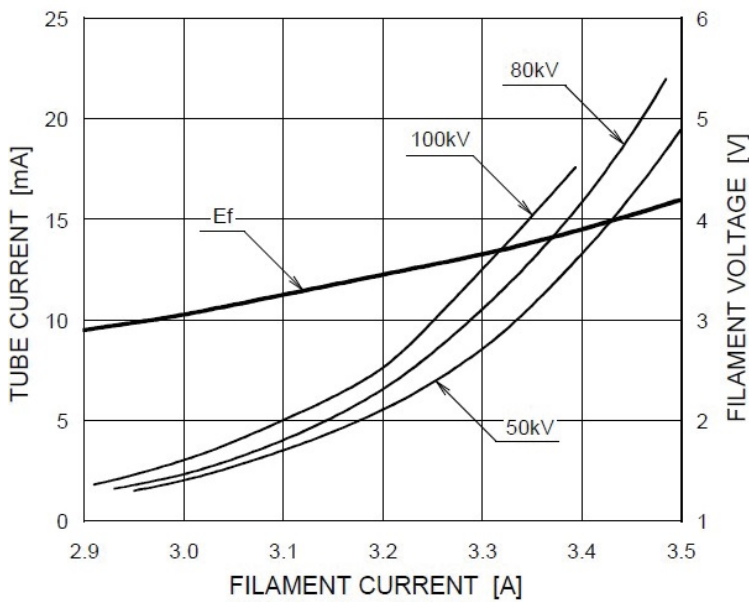

■ ■ Anode Thermal Characteristics

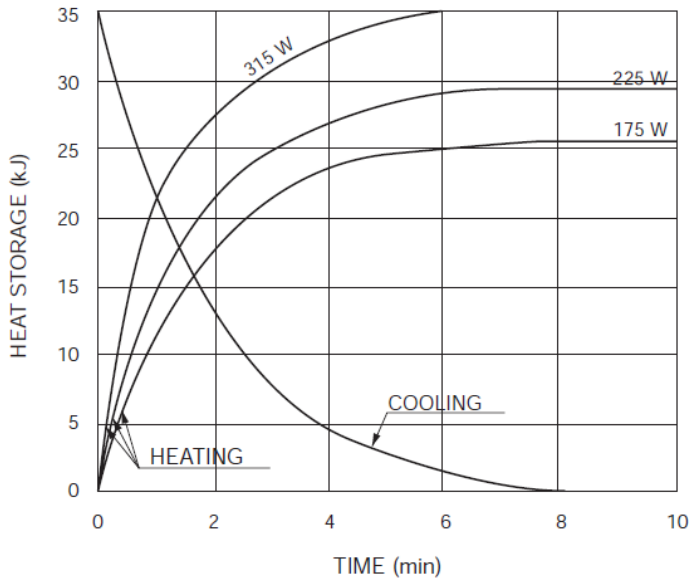

■ ■ X-ray Tube Assembly Heating / Cooling Curve

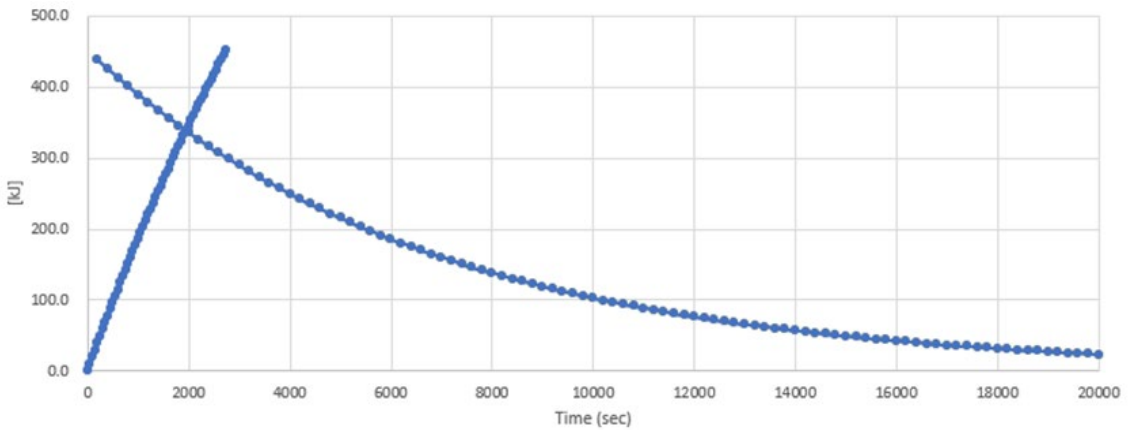

13.2.2 Detector Specifications

■ PaX-i Plus

Item	Description	
	PANO	CEPH
Model	Xmaru1501CF-PLUS	Xmaru2602CF
Detector Type	CMOS photodiode array	
Pixel size	100 μm @ Full Resolution	200 μm @ 2X2 Binning
Active area	151.2 mm x 6.0 mm	259.2 mm x 15.6 mm
Frame Rate	~ 287 Hz @ Full Resolution	~ 330 Hz @ 2x2 binning
Analogue-Digital Conversion	14 bits	
Operating Condition	10 ~ 35 °C (Temperature) / 10 ~ 75 % (Humidity)	
Storage Condition	-10 ~ 60 °C (Temperature) / 10 ~ 75 % (Humidity)	
Sensor size	174 (W) x 79 (L) x 30.2 (H) mm	279 (W) x 110 (L) x 20 (H) mm
Sensor Weight	0.45 Kg	1.3 Kg
Converter	CsI:Ti	
Energy Range	50 - 120 kVp	
Readout	Charge amplifier array	
Video Output	Optic	
MTF	> 55 % @ 1 lp/mm	> 35 % @ 1 lp/mm
	> 13 % @ 2.5 lp/mm	> 5 % @ 2.5 lp/mm
DQE	> 70 % @ 0 lp/mm	> 60 % @ 0 lp/mm
Dynamic Range	\geq 70dB	\geq 70dB

■ PaX-i Insight

Item	Description	
	PANO	CEPH
Model	Xmaru1404CF-PLUS	Xmaru2602CF
Detector Type	CMOS photodiode array	
Pixel size	198 μm @ 4X4 Binning	200 μm @ 2X2 Binning
Active area	135.8 mm x 36.4 mm	259.2 mm x 15.6 mm
Frame Rate	~ 308 Hz @ 4x4 binning	~ 330 Hz @ 2x2 binning
Analogue-Digital Conversion	14 bits	
Operating condition	10 ~ 35 °C (Temperature) / 10 ~ 75 % (Humidity)	
Storage condition	-10 ~ 60 °C (Temperature) / 10 ~ 75 % (Humidity)	
Sensor size	230 (W) x 160 (L) x 26 (H) mm	279 (W) x 110 (L) x 20 (H) mm
Sensor weight	1.5Kg	1.3Kg
Converter	Csl:Ti	
Energy Range	50 – 120 kVp	
Readout	Charge amplifier array	
Video Output	Optic	
MTF	> 45% @ 1 lp/mm > 8% @ 2.5lp/mm	>35% @1 lp/mm >5% @ 2.5 lp/mm
DQE	> 60% @ ~0lp/mm	> 60% @ ~0lp/mm
Dynamic Range	> 80dB	≥70dB

13.3 Electrical Specifications

Item	Description
Power supply voltage	100 - 240 V ~
Frequency	50 / 60 Hz
Power rating	1.3 kVA
Accuracy	Tube Voltage (kVp) $\pm 10 \%$ Tube Current (mA) $\pm 20 \%$ Exposure Time (s) $\pm (5 \% + 50 \text{ ms})$

- The input line voltage depends on the local electrical distribution system.
- Allowable input voltage fluctuation requirement: $\pm 10 \%$.
- Mode of operation: Continuous operation with intermittent loading - Needs waiting time (at least 60 times the exposure time) before the next exposure begins.
- Column operation time: Max. 2 min. On / 18 min. Off (Ratio 1:9)

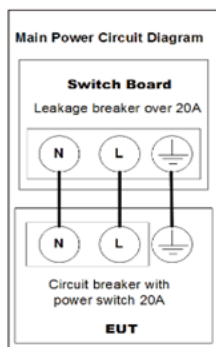
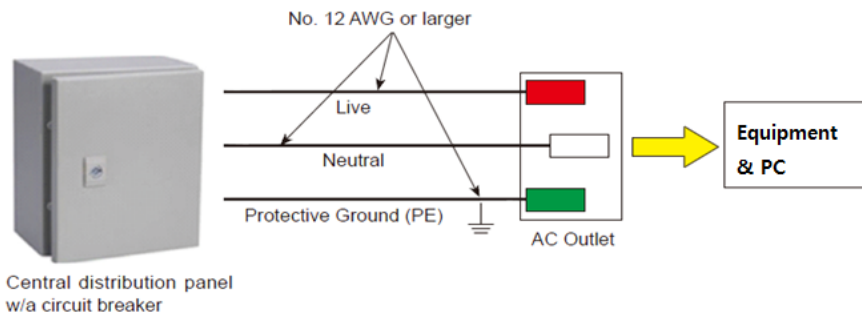

NOTICE

- To assure line voltage quality, a separate 3-core grounded power cable connected directly to the central distribution panel with an over-current circuit breaker rated for 20A must be used.
- Maximally allowed deviation of the tube voltage/tube current/exposure time:
Tube Voltage (kVp) $\pm 10\%$ / Tube Current (mA) $\pm 20\%$ / Exposure Time (s) $\pm (5\% + 50\text{ ms})$ according to IEC 60601-2-63.
- The mains resistance should not exceed 0.045 ohms at 100 V and 0.19 ohm at 240 V.

13.4 Environmental Specifications

	Item	Description
During Operation	Temperature	10 ~ 35 °C
	Relative humidity	30 ~ 75 %
	Atmospheric pressure	860 ~ 1060 hPa
During Transport and Storage	Temperature	-10 ~ 60 °C
	Relative humidity	10 ~ 75 %
	Atmospheric pressure	860 ~ 1060 hPa

This page intentionally left blank

14. Appendices

14.1 Recommended X-ray Exposure Tables

14.1.1 PANO Mode

Exposure Condition

■ PANO Option > Normal

Mode	Image Option	Gender / Age group	X-ray Intensity	Tube Voltage (kVp)	Tube Current (mA)
PANO Examination	UHD (Optional) / HD	Man	Hard	74	9
			Normal	73	9
			Soft	72	9
		Woman	Hard	73	9
			Normal	72	9
			Soft	71	9
		Child	Hard	68	9
			Normal	67	9
			Soft	66	9
	Normal	Man	Hard	74	7
			Normal	73	7
			Soft	72	7
		Woman	Hard	73	7
			Normal	72	7
			Soft	71	7
Child		Hard	68	7	
		Normal	67	7	
		Soft	66	7	
SPECIAL Examination	N/A	Man	Hard	74	9
			Normal	73	9
			Soft	72	9

Mode	Image Option	Gender / Age group	X-ray Intensity	Tube Voltage (kVp)	Tube Current (mA)
		Woman	Hard	73	9
			Normal	72	9
			Soft	71	9
		Child	Hard	68	9
			Normal	67	9
			Soft	66	9

■ PANO Option > Auto Focusing (Optional)

Mode	Image Option	Gender / Age group	X-ray Intensity	Tube Voltage (kVp)	Tube Current (mA)
PANO Examination	UHD (Optional) / HD	Man	Hard	74	9
			Normal	73	9
			Soft	72	9
		Woman	Hard	73	9
			Normal	72	9
			Soft	71	9
		Child	Hard	68	9
			Normal	67	9
			Soft	66	9
	Normal	Man	Hard	74	7
			Normal	73	7
			Soft	72	7
		Woman	Hard	73	7
			Normal	72	7
			Soft	71	7
		Child	Hard	68	7
			Normal	67	7

Mode	Image Option	Gender / Age group	X-ray Intensity	Tube Voltage (kVp)	Tube Current (mA)
			Soft	66	7

- *Auto Focusing is not available for SPECIAL Examination programs.*

■ PANO Option > Insight PAN (PaX-i Insight only)

Mode	Image Option	Gender / Age group	X-ray Intensity	Tube Voltage (kVp)	Tube Current (mA)
PANO Examination / SPECIAL Examination	N/A	Man	Hard	71	5
			Normal	70	5
			Soft	69	5
		Woman	Hard	71	5
			Normal	70	5
			Soft	69	5
		Child	Hard	68	5
			Normal	67	5
			Soft	66	5

Scan Time / Exposure Time■ **PANO Examination**

Arch Type	Examination Mode	Image Option					
		UHD (Optional)		HD		Normal	
		Scan Time (s)	Exposure Time (s)	Scan Time (s)	Exposure Time (s)	Scan Time (s)	Exposure Time (s)
Narrow	Standard	21.0	20.2	14.0	13.5	10.4	10.1
	Right	21.0	10.1	14.0	6.7	10.4	5.0
	Front	21.0	16.7	14.0	11.2	10.4	8.4
	Left	21.0	10.1	14.0	6.7	10.4	5.0
Normal	Standard	21.0	20.2	14.0	13.5	10.4	10.1
	Right	21.0	10.1	14.0	6.7	10.4	5.0
	Front	21.0	16.7	14.0	11.2	10.4	8.4
	Left	21.0	10.1	14.0	6.7	10.4	5.0
Wide	Standard	21.0	20.2	14.0	13.5	10.4	10.1
	Right	21.0	10.1	14.0	6.7	10.4	5.0
	Front	21.0	16.7	14.0	11.2	10.4	8.4
	Left	21.0	10.1	14.0	6.7	10.4	5.0
Child	Standard	18.1	17.2	12.1	11.5	8.9	8.6
	Right	18.1	8.6	12.1	5.7	8.9	4.3
	Front	18.1	13.8	12.1	9.2	8.9	6.8
	Left	18.1	8.6	12.1	5.7	8.9	4.3
Orthogonal	Standard	21.0	20.2	14.0	13.5	10.4	10.1
	Right	21.0	10.1	14.0	6.7	10.4	5.0
	Front	21.0	16.7	14.0	11.2	10.4	8.4
	Left	21.0	10.1	14.0	6.7	10.4	5.0
	Bitewing	21.0	14.5	14.0	9.7	10.4	7.3
	Bitewing Incisor	21.0	3.7	14.0	2.5	10.4	1.8

Arch Type	Examination Mode	Image Option					
		UHD (Optional)		HD		Normal	
		Scan Time	Exposure Time	Scan Time	Exposure Time	Scan Time	Exposure Time
		(s)	(s)	(s)	(s)	(s)	(s)
	(Optional)						
	Bitewing Right	21.0	7.3	14.0	4.8	10.4	3.6
	Bitewing Left	21.0	7.3	14.0	4.8	10.4	3.6

- *For Insight PAN mode, only "Normal" is applied to Image Options.*
- *Scan Time: The actual time that the equipment shoots the patient except for the initial acceleration and late deceleration stages.*
- *Exposure Time: The actual time that the patient is exposed to the X-ray emission.*

■ SPECIAL Examination

Examination Mode	Scan Time (s)	Exposure Time (s)
TMJ LAT Open / TMJ LAT Close	14.0	6.2
TMJ PA Open (Optional) / TMJ PA Close (Optional)	13.0	10.1
Sinus LAT (Optional)	6.5	5.9
Sinus PA	10.9	10.3

- *Scan Time: The actual time that the equipment shoots the patient except for the initial acceleration and late deceleration stages.*
- *Exposure Time: The actual time that the patient is exposed to the X-ray emission.*

14.1.2 CEPH Mode

Exposure Condition

Examination Program	Image Option	Gender / Age group	X-ray Intensity	Tube Voltage (kVp)	Tube Current (mA)
Lateral Full Lateral PA SMV Waters' view	Normal / Fast	Man	Hard	92	10.0
			Normal	90	10.0
			Soft	88	10.0
		Woman	Hard	90	10.0
			Normal	88	10.0
			Soft	86	10.0
		Child	Hard	88	10.0
			Normal	86	10.0
			Soft	84	10.0
Carpus	Normal / Fast	Man	Hard	90	6.0
			Normal	88	6.0
			Soft	86	6.0
		Woman	Hard	88	6.0
			Normal	86	6.0
			Soft	84	6.0
		Child	Hard	86	6.0
			Normal	84	6.0
			Soft	82	6.0

Scan Time / Exposure Time

Examination Program	Image Option			
	Normal		Fast	
	Scan Time (s)	Exposure Time (s)	Scan Time (s)	Exposure Time (s)
Lateral	3.9	3.9	1.9	1.9
Full Lateral	5.4	5.4	3.9	3.9
PA	4.9	4.9	2.4	2.4
SMV	4.9	4.9	2.4	2.4
Waters' view	4.9	4.9	2.4	2.4
Carpus	4.9	4.9	2.4	2.4

- *Scan Time: The actual time that the equipment shoots the patient except for the initial acceleration and late deceleration stages.*
- *Exposure Time: The actual time that the patient is exposed to the X-ray emission.*

14.2 X-ray Dose Data

14.2.1 DAP (Dose Area Product)

The X-ray dose data is extracted from the X-ray Dose Test Report for **PaX-i Plus / PaX-i Insight (Model: PCH-30CS)**.

X-ray Dose Test Report for the **PCH-30CS** maintains dosimetry evaluation that the **VATECH** dental diagnostic system meets all requirements specified in the IEC Collateral Standard. To limit unnecessary exposure to the patient, operator, or other staff, **PCH-30CS** is designed to comply with IEC 60601-1-3 Part 1 General Requirements for Safety.

Test Hardware	
Brand Name (Model)	PaX-i Plus / PaX-i Insight (Model: PCH-30CS)
Sensor Type	<PaX-i Plus> PANO: Xmaru1501CF-PLUS CEPH: Xmaru2602CF
	<PaX-i Insight> PANO: Xmaru1404CF-PLUS CEPH: Xmaru2602CF
X-ray Generator	DG-07D21T2
Tube	D-052SB

DAP (Dose Area Product) is a quantity used in assessing the radiation risk from diagnostic X-ray examination procedures. It is defined as the absorbed dose multiplied by the area irradiated, expressed in gray square centimeters ($\text{mGy}\cdot\text{cm}^2$). Despite the limitation, DAP is the best way to predict effective dose value and is currently the most convenient method for patient dose monitoring.

- *PHE (Public Health England) recommends that any national reference dose that achievable dose (DAP) value of 250 [$\text{mGy}\cdot\text{cm}^2$] for a clinical protocol for a standard male patient.*

Standard

National Deviations	Terminology	Permissive Range
PHE (GBR)	DAP (Pano and CEPH)	PANO: $\leq 93 \text{ mGy}\cdot\text{cm}^2$ (Adult) / $67 \text{ mGy}\cdot\text{cm}^2$ (Child) CEPH: $\leq 40 \text{ mGy}\cdot\text{cm}^2$ (Adult, Lateral) / $25 \text{ mGy}\cdot\text{cm}^2$ (Child, Lateral)
AERB (IND)	Dose	All dose values must be within $\pm 20 \%$ of the SPECIFIED values

DAP (Dose Area Product) Calculation

$$\text{DAP}[\text{mGy} \cdot \text{cm}^2] = \text{Dose}[\text{mGy}] \times \text{Exposed Area}[\text{cm}^2]$$

NOTICE

When you need more information on DAP measurement procedures or test results for the equipment, please contact **VATECH** service center or your local **VATECH** representative and get assistance from **VATECH**-authorized technicians

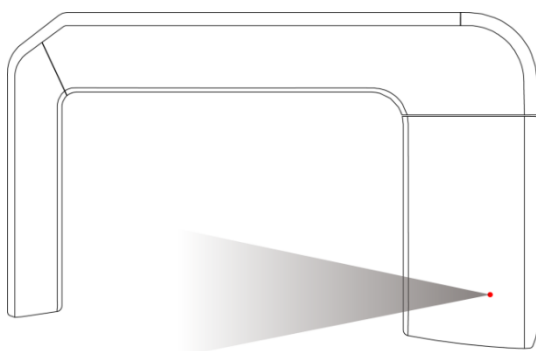
Measurement Overview**Results**

■ PaX-i Plus

<PANO>

PANO Option	Image Option	Arch Selection	Gender / Age group	Tube Voltage (kVp)	Tube Current (mA)	DAP (mGy·cm ²)
Normal	UHD	Normal	Adult	73	9	220
			Child	67	9	127
	HD	Normal	Adult	73	9	148
			Child	67	9	85
	Normal	Normal	Adult	73	7	88
			Child	67	7	49

<CEPH>

CEPH Examination	Image Option	Gender / Age group	Tube Voltage (kVp)	Tube Current (mA)	DAP (mGy·cm ²)
Lateral	Normal	Adult	90	10	23
		Child	86	10	21
	Fast	Adult	90	10	13
		Child	86	10	12

- PaX-i Insight

<PANO>

PANO Option	Image Option	Arch Selection	Gender / Age group	Tube Voltage (kVp)	Tube Current (mA)	DAP (mGy·cm ²)
Normal	UHD	Normal	Adult	73	9	204
			Child	67	9	127
	HD	Normal	Adult	73	9	138
			Child	67	9	85
	Normal	Normal	Adult	73	7	81
			Child	67	7	50
Insight PAN	Normal	Normal	Adult	70	5	374
			Child	67	5	245

<CEPH>

CEPH Examination	Image Option	Gender / Age group	Tube Voltage (kVp)	Tube Current (mA)	DAP (mGy·cm ²)
Lateral	Normal	Adult	90	10	23
		Child	86	10	21
	Fast	Adult	90	10	13
		Child	86	10	12

14.2.2 Leakage Dose

X-ray Leakage Dose Test is performed to protect patients against excessive and unnecessary radiation that is not purposed, and this document evaluates leakage dose amount based on the following standard defined by IEC regulation and has been performed by covering each collimator region in use.

Standard

National Deviation	Terminology	Permissive Range
International Standard IEC 60601-1-3	Leakage	limits leakage at 1M from the source to 1.0 mGy in 1hr

Measurement Overview

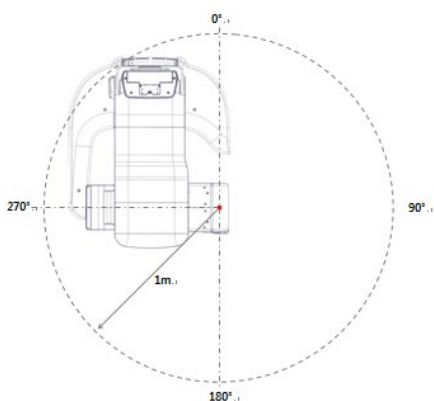

■ PaX-i Plus

Test Condition

Test Mode	Tube Voltage (kVp)	Tube Current (mA)
PANO Adult / Normal	99	10
PANO Child / Normal	99	10
CEPH	99	10

Results

Direction [°]	PANO Adult / Normal [mGy/hr]	PANO Child / Normal [mGy/hr]	CEPH [mGy/hr]
0	0.044	0.035	0.053
45	0.035	0.053	0.026
90	0.096	0.096	0.114
100	0.079	0.079	0.096
110	0.088	0.088	0.096
120	0.202	0.272	0.254
130	0.105	0.114	0.123
140	0.105	0.105	0.114
150	0.114	0.105	0.114
160	0.114	0.114	0.114
170	0.123	0.132	0.132
180	0.158	0.167	0.167
190	0.184	0.175	0.184
200	0.360	0.272	0.342
210	0.325	0.333	0.316
220	0.263	0.281	0.263
230	0.228	0.237	0.211
240	0.307	0.289	0.281

Direction [°]	PANO Adult / Normal [mGy/hr]	PANO Child / Normal [mGy/hr]	CEPH [mGy/hr]
250	0.228	0.219	0.211
260	0.228	0.272	0.325
270	0.421	0.439	0.456
315	0.158	0.096	0.114
340	0.430	0.132	0.140

■ PaX-i Insight

Test Condition

Test Mode	Tube Voltage (kVp)	Tube Current (mA)
PANO Adult / Normal	99	10
PANO Child / Normal	99	10
PANO Adult / Insight PAN	99	10
PANO Child / Insight PAN	99	10
CEPH	99	10

Results

Direction [°]	PANO Adult / Normal [mGy/hr]	PANO Child / Normal [mGy/hr]	PANO Adult / Insight PAN [mGy/hr]	PANO Child / Insight PAN [mGy/hr]	CEPH [mGy/hr]
0	0.026	0.096	0.035	0.026	0.018
45	0.053	0.018	0.035	0.026	0.018
90	0.088	0.096	0.088	0.079	0.096
100	0.088	0.096	0.088	0.088	0.088
110	0.211	0.246	0.219	0.158	0.140
120	0.123	0.132	0.114	0.123	0.114
130	0.114	0.132	0.114	0.105	0.105
140	0.114	0.114	0.105	0.114	0.105

Direction [°]	PANO Adult / Normal [mGy/hr]	PANO Child / Normal [mGy/hr]	PANO Adult / Insight PAN [mGy/hr]	PANO Child / Insight PAN [mGy/hr]	CEPH [mGy/hr]
150	0.132	0.123	0.123	0.123	0.123
160	0.132	0.149	0.140	0.149	0.140
170	0.158	0.167	0.158	0.167	0.149
180	0.175	0.263	0.237	0.219	0.219
190	0.351	0.342	0.333	0.351	0.333
200	0.298	0.316	0.289	0.298	0.298
210	0.219	0.237	0.211	0.237	0.219
220	0.184	0.202	0.184	0.184	0.184
230	0.228	0.254	0.184	0.193	0.219
240	0.175	0.193	0.158	0.167	0.167
250	0.219	0.272	0.219	0.237	0.228
260	0.237	0.237	0.211	0.219	0.219
270	0.325	0.316	0.281	0.298	0.289
315	0.123	0.219	0.088	0.079	0.079
340	0.228	0.088	0.123	0.158	0.263

14.2.3 Scattered Dose

X-ray Scattered Dose data concerning varied angle and distance is examined for recommendations about appropriate radiation level insignificant zones of occupancy and the effectiveness of protective shielding facility around the patient's position. This information states the identity and intended position of the tested phantom and scattered dosimetry evaluation under the defined scope and test circumstances to ensure the magnitude of risks to the operator and staff, during both accident situations and routine work.

Measurement Overview

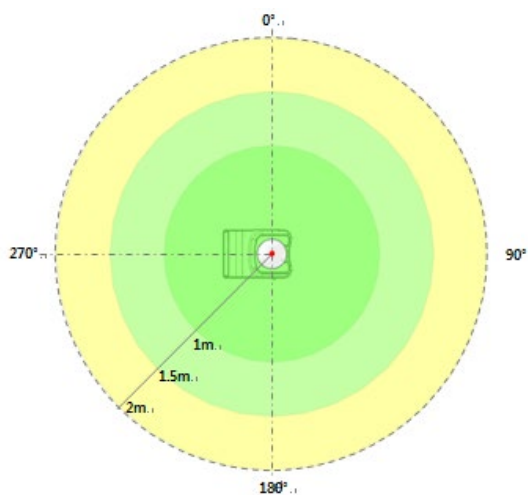

■ PaX-i Plus

Test Condition

Test Mode	Tube Voltage (kVp)	Tube Current (mA)	Exposure Time (s)
PANO Adult (UHD) / Normal	99	10	20.2
PANO Adult (HD) / Normal	99	10	13.5

Results

◆ PANO Adult (UHD) / Normal

Direction [°]	1 m [mGy/hr]	1.5 m [mGy/hr]	2 m [mGy/hr]
0	1.158	0.518	0.289
45	0.939	0.421	0.237
90	0.518	0.237	0.132
135	0.561	0.254	0.140
180	0.474	0.211	0.123
225	0.588	0.263	0.149
270	0.868	0.386	0.219
315	1.772	0.789	0.447

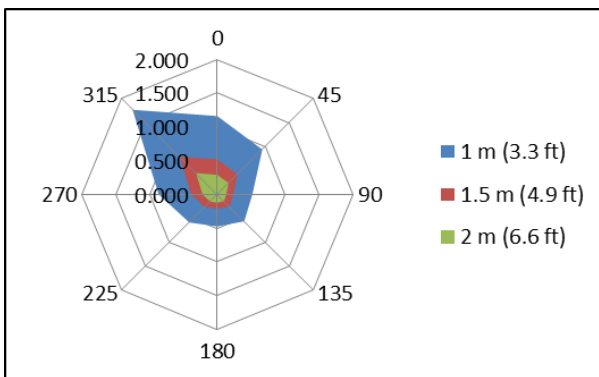

◆ PANO Adult (HD) / Normal

Direction [°]	1 m [mGy/hr]	1.5 m [mGy/hr]	2 m [mGy/hr]
0	0.789	0.351	0.193
45	0.825	0.368	0.202
90	0.614	0.272	0.149
135	0.623	0.272	0.158
180	0.509	0.228	0.123
225	0.500	0.219	0.123
270	0.728	0.325	0.184
315	1.421	0.632	0.351

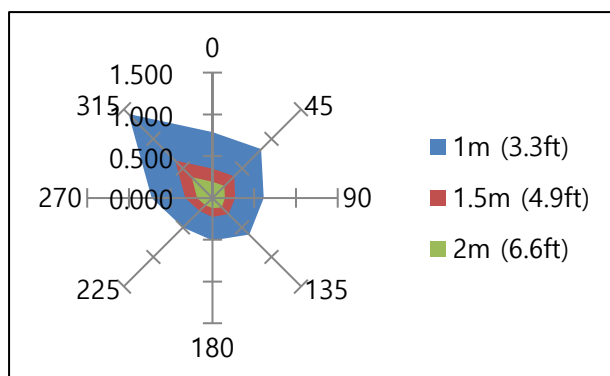

■ PaX-i Insight

Test Condition

Test mode	Tube Voltage (kVp)	Tube Current (mA)	Exposure Time (s)
PANO Adult (UHD) / Normal	99	10	20.2
PANO Adult (HD) / Normal	99	10	13.5
PANO Adult (Normal) / Insight PAN	99	10	10.1.

Results

◆ PANO Adult (UHD) / Normal

Direction [°]	1 m [mGy/hr]	1.5 m [mGy/hr]	2 m [mGy/hr]
0	0.649	0.289	0.158
45	0.596	0.263	0.149
90	0.421	0.184	0.105
135	0.579	0.254	0.140
180	0.456	0.202	0.114
225	0.518	0.228	0.132
270	0.737	0.325	0.184
315	1.333	0.588	0.333

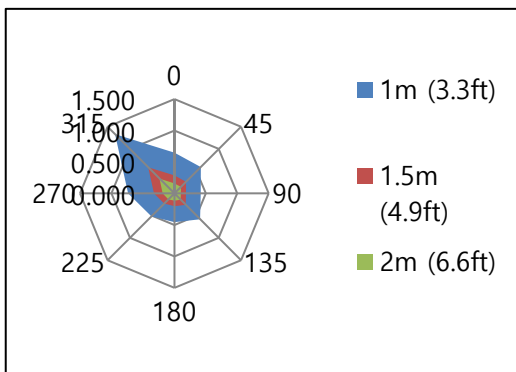

◆ PANO Adult (HD) / Normal

Direction [°]	1 m [mGy/hr]	1.5 m [mGy/hr]	2 m [mGy/hr]
0	0.649	0.289	0.158
45	0.614	0.272	0.149
90	0.412	0.184	0.105
135	0.596	0.263	0.149
180	0.509	0.228	0.123
225	0.544	0.237	0.132
270	0.711	0.316	0.175
315	1.298	0.579	0.325

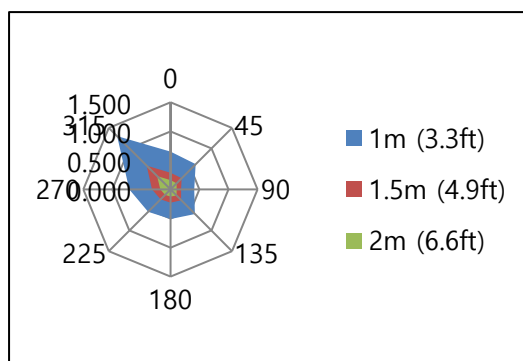

◆ PANO Adult (Normal) / Insight PAN

Direction [°]	1 m [mGy/hr]	1.5 m [mGy/hr]	2 m [mGy/hr]
0	5.623	2.491	1.395
45	3.553	1.570	0.886
90	2.377	1.053	0.588
135	2.965	1.316	0.737
180	2.254	1.000	0.561
225	2.351	1.044	0.588
270	2.228	0.982	0.553
315	5.868	2.596	1.456

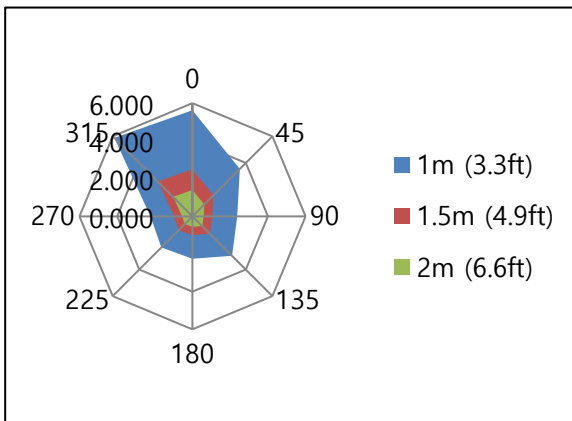

14.3 Electromagnetic Compatibility (EMC) Information

Phenomenon	Basic EMC standard or test method	Operating mode	Port tested	Test Voltage	Test level/requirement
Mains terminal disturbance voltage	CISPR 11:2009+A1:2010	IDLE mode PANO mode CEPH mode	AC Mains of the power supply unit	AC 100 V, 50 Hz AC 100 V, 60 Hz AC 220 V, 60 Hz AC 230 V, 50 Hz	Group1, Class A
Radiated disturbance	CISPR 11:2009+A1:2010	IDLE mode PANO mode CEPH mode	Enclosure	AC 100 V, 50 Hz AC 100 V, 60 Hz AC 220 V, 60 Hz AC 230 V, 50 Hz	Group1, Class A
Harmonic Current Emission	EN 61000-3-2:2006+A1:2009, IEC 61000-3-2:2009	IDLE mode PANO mode CEPH mode	AC Mains of the power supply unit	AC 230 V, 50 Hz	Class A
Voltage change, Voltage fluctuations and Flicker Emission	EN 61000-3-3:2008, IEC 61000-3-3:2008	IDLE mode PANO mode CEPH mode	AC Mains of the power supply unit	AC 230 V, 50 Hz	Pst: 1 Plt: 0.65 dmax: 4% dc: 3.3%
Electrostatic Discharge Immunity	EN 61000-4-2:2009, IEC 61000-4-2:2008	IDLE mode PANO mode CEPH mode	Enclosure	AC 100 V, 50 Hz AC 100 V, 60 Hz AC 220 V, 60 Hz AC 230 V, 50 Hz	± 8 kV/Contact ± 2, ± 4, ± 8, ± 15 kV/Air
Radiated RF Electromagnetic Field Immunity	EN 61000-4-3:2006 +A2:2010, IEC 61000-4-3:2010	IDLE mode PANO mode CEPH mode	Enclosure	AC 100 V, 50 Hz AC 100 V, 60 Hz AC 220 V, 60 Hz AC 230 V, 50 Hz	3 V/m 80 MHz-2.7 GHz 80% AM at 1 kHz
Immunity to Proximity Fields from RF wireless Communicati	EN 61000-4-3:2006 +A2:2010, IEC 61000-4-3:2010	IDLE mode PANO mode CEPH mode	Enclosure	AC 100 V, 50 Hz AC 100 V, 60 Hz AC 220 V, 60 Hz AC 230 V, 50 Hz	Table 9 in IEC 60601-1-2:2014

Phenomenon	Basic EMC standard or test method	Operating mode	Port tested	Test Voltage	Test level/requirement
ons Equipment					
Electrical Fast Transient/Burst Immunity	EN 61000-4-4:2012, IEC 61000-4-4:2012	IDLE mode PANO mode CEPH mode	AC Mains	AC 100 V, 50 Hz AC 100 V, 60 Hz AC 220 V, 60 Hz AC 230 V, 50 Hz	AC Line: ± 2 kV Signal: ± 1 kV 100 kHz repetition frequency
Surge Immunity	EN 61000-4-5:2014, IEC 61000-4-5:2014	IDLE mode PANO mode CEPH mode	AC Mains of the power supply unit	AC 100 V, 50 Hz AC 100 V, 60 Hz AC 220 V, 60 Hz AC 230 V, 50 Hz	Line to Line ± 0.5 kV, ± 1 kV Line to Ground ± 0.5 kV, ± 1 kV, ± 2 kV
Immunity to Conducted Disturbances Induced by RF fields	EN 61000-4-6:2014, IEC 61000-4-6:2013	IDLE mode PANO mode CEPH mode	AC Mains	AC 100 V, 50 Hz AC 100 V, 60 Hz AC 220 V, 60 Hz AC 230 V, 50 Hz	AC Line & Signal: 3 V, 0.15-80 MHz
			Hand piece cable		6 V in ISM bands Between 0.15 MHz and 80 MHz 80% AM at 1 kHz
Power Frequency Magnetic Field Immunity	EN 61000-4-8:2010, IEC 61000-4-8:2009	IDLE mode PANO mode CEPH mode	Enclosure	AC 100 V, 50 Hz AC 100 V, 60 Hz AC 220 V, 60 Hz AC 230 V, 50 Hz	30 A/m 50 Hz & 60 Hz
Voltage dips	EN 61000-4-11:2004,	IDLE mode PANO mode CEPH mode	AC Mains of the power supply unit	AC 100 V, 50 Hz AC 100 V, 60 Hz	0 % U_T : 0.5 cycle At 0°, 45°, 90°, 135°,

Phenomenon	Basic EMC standard or test method	Operating mode	Port tested	Test Voltage	Test level/requirement
	IEC 61000-4-11:2004			AC 220 V, 60 Hz AC 240 V, 50 Hz AC 240 V, 60 Hz	180°, 225°, 270° and 315° 0 % U_T ; 1 cycle and 70 % U_T ; 25/30 cycles Single-phase: at 0°
Voltage interruptions	EN 61000-4-11:2004, IEC 61000-4-11:2004	IDLE mode PANO mode CEPH mode	AC Mains of the power supply unit	AC 100 V, 50 Hz AC 100 V, 60 Hz AC 220 V, 60 Hz AC 240 V, 50 Hz AC 240 V, 60 Hz	0 % U_T ; 250/300 cycle

14.4 Hand-wrist Image Evaluation References

Radiographic Evaluation of Skeletal Maturation. A clinically oriented method based on hand-wrist films.

Fishman LS. 1982

The system of Skeletal Maturation Assessment (SMA)

The System uses only four stages of bone maturation, all found at six anatomical sites located on the thumb, third finger, fifth finger, and radius, as seen in Fig.1. Eleven discrete adolescent skeletal maturational indicators (SMI's), covering the entire period of adolescent development, are found on these six sites (Fig.1 orange circles).

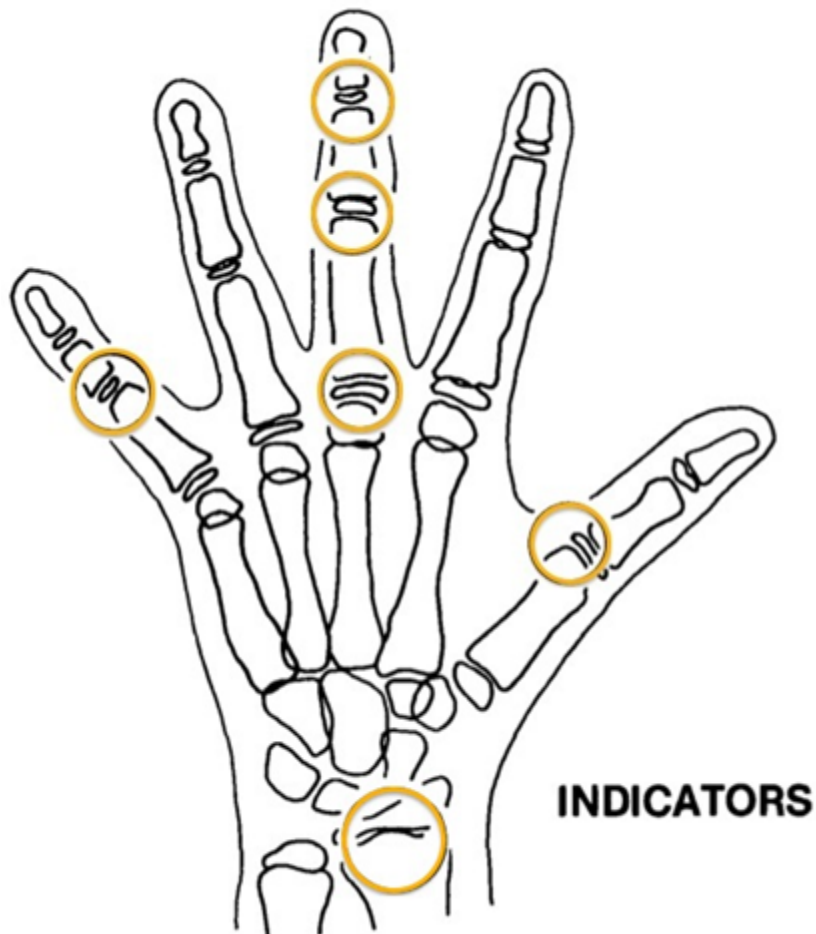

[Fig1. The site of skeletal maturity indicators]

Skeletal Maturity Indicators (SMI)

A system of skeletal maturation assessment based on four stages of bone maturation at six anatomical sites in the hand wrist.

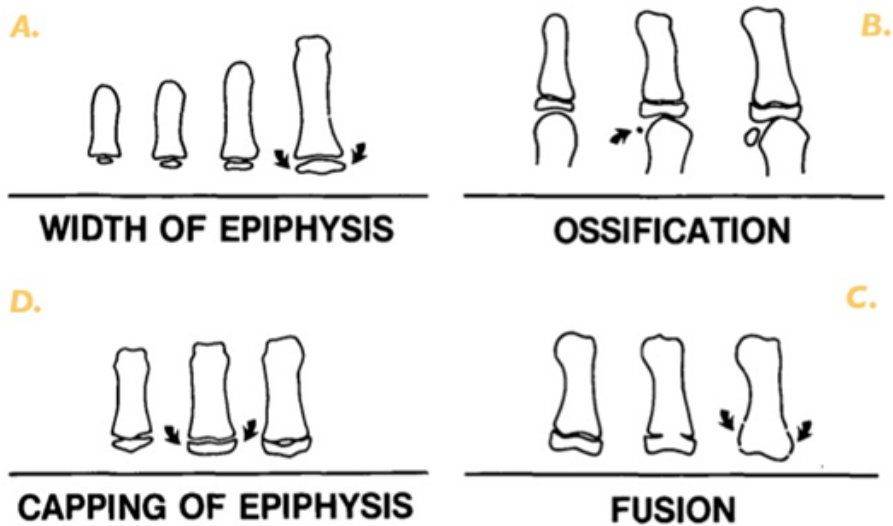

Fig. 2 Radiographic identification of skeletal maturity indicators.
 A. Epiphysis equal in width to diaphysis.
 B. Appearance of adductor sesamoid of the thumb.
 C. Capping of epiphysis.
 D. Fusion of epiphysis.

[Fig2. Radiographic identification of skeletal maturity indicators]

A. The width of epiphysis as wide as the diaphysis

1. Third finger – a Proximal phalanx
2. Third finger – a middle phalanx
3. Fifth finger – a middle phalanx

B. Ossification

1. Adductor sesamoid of thumb

C. Capping of epiphysis

1. Third finger – a distal phalanx
2. Third finger – a middle phalanx
3. Fifth finger – a middle phalanx

D. Fusion

1. Third finger – a distal phalanx
2. Third finger – a Proximal phalanx
3. Third finger – a middle phalanx
4. Radius

Eleven Skeletal maturity indicators (SMIs)

The System uses only four stages of bone maturation, all found at six anatomical sites located on the thumb, third finger, fifth finger, and radius, as seen in Fig.1. Eleven discrete adolescent skeletal maturational indicators (SMI's), covering the entire period of adolescent development, are found on these six sites (Fig.1 orange circles).

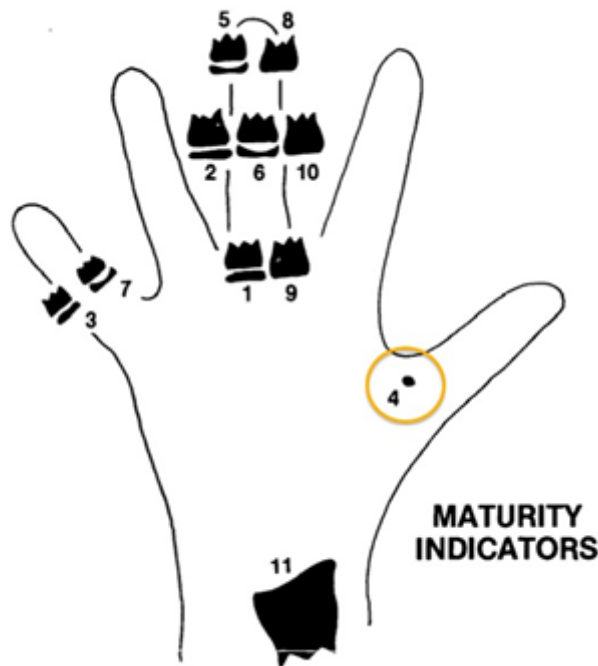

[Fig3. Eleven Skeletal maturity indicators (SMIs)]

A systematic observational scheme such as that shown in the figure above can further facilitate SMI evaluation. With this approach, key stages are checked first, rather than looking for maturity indicators in numerical order. A useful step is to determine if the adductor sesamoid of the thumb can be seen (orange circle). If not, then the applicable SMI will be one of those associated with early epiphyseal widening rather than capping. If the sesamoid is visible, then either the sesamoid or an SMI based on capping or fusion will be applicable.

HAND-WRIST OBSERVATION SCHEME

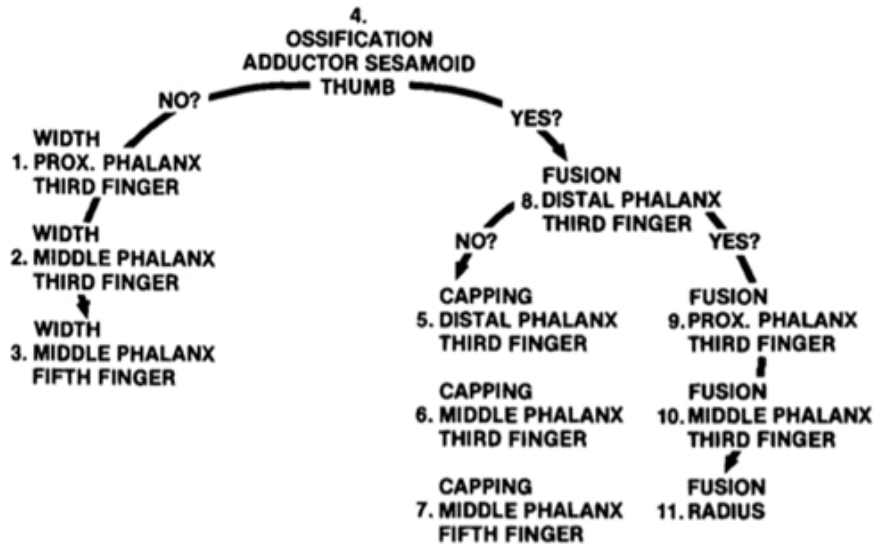

14.5 Acquiring Images for Pediatric Dental Patients

14.5.1 Age Group: Classification Table

Ages are classified loosely into the following correspondence between FDA definition and one used in this manual.

Age Group	FDA's standard	VATECH's Standard
Infant	1 month to 2 years	N/A
Child	2 ~ 12 years of age	Child
Adolescent	12 ~16 years of age	Adult
Other	16 ~ 21 years of age	
Adult	> 21 years of age	

14.5.2 Positioning the Pediatric Dental Patients

1. Use a laser light beam guide to locate the midsagittal plane. The direct patient focuses to mirror reflection. Affix decal to mirror to aid the patient in maintaining the correct position throughout the exposure.
2. Move the Chinrest into a position that is slightly higher than the patient's chin height before requesting that the patient place chin on the rest. Direct the patient to assume a position that resembles the erect stance of a soldier.
3. Direct the patient to stick out the chest while dropping the chin down. While holding the unit handles for stability, direct the patient to take a half step toward the vertical column of the X-ray device into a position that feels as if he/she is slightly leaning backward.
4. Direct the patient to close lips around the Bite Block during the exposure.
5. Direct the patient to swallow and note the flat position of the tongue. Request that the patient sucks in the cheeks, pushing the tongue into the correct flat position against the palate, and maintain this position throughout the exposure.

<How to product error-free radiographic images for the pediatric patient>

(<http://www.dimensionsofdentalhygiene.com/print.aspx?id=3612>)

- By Evelyn M. Thomson, BSDH, MS

Panoramic radiographs are often recommended for assessing the growth and development of the pediatric patient and for evaluation of developing third molars during adolescence.¹⁻³ While the panoramic technique seems relatively straightforward, producing a diagnostic quality image of the pediatric patient requires a mastery of technical skills.⁴ Modern panoramic x-ray equipment is designed for ease of use, yet studies continue to demonstrate a high incidence of errors.⁵⁻⁷ Positioning errors may occur at an even higher rate in pediatric panoramic radiographs.⁷ The goal of the dental hygienist is to maximize the use of panoramic imagery in the assessment of the pediatric patient while minimizing the occurrence of retakes that result from the radiographic error.

Producing A Quality Panoramic Image

A quality panoramic radiograph should image all the teeth, erupted and unerupted, in both the maxillary and mandibular arches from condyle to condyle in the horizontal dimension, and from the superior third of the orbit in the superior region to the inferior border of the mandible in the inferior region.^{8,9} The arches should appear straight or slightly U-shaped with the occlusal plane parallel to the horizontal edges of the film (**Figure 1**). The anterior teeth must not be magnified or diminished in size and overlapping of adjacent posterior teeth should be kept to a minimum.



Figure 1: Example of a diagnostically acceptable panoramic radiograph of an adolescent patient undergoing orthodontic intervention. (Courtesy of Jamie Mace and Will Wright of Schick Technologies Inc.)

The most important component in producing a diagnostically acceptable panoramic image is patient positioning. All panoramic x-ray machines have guidelines to assist

with positioning the dental arches within the three dimensions of the focal trough, an area where the anatomical structures will be imaged in relative clarity. Most panoramic x-ray machines have a bite block to indicate the correct anterior-posterior position or how far forward or back the patient should be positioned, side positioner guides for determining the correct lateral alignment, and chin rest to correctly locate the superior-inferior dimension or how far up or down the chin should be positioned.^{4,10} Panoramic x-ray machines are available with a mirror and laser light beam guide that shines on the patient's face to illustrate various anatomical planes (**Figure 2**). Incorrectly positioning the patient in any of these three dimensions will produce unique and distinct radiographic image errors (**Table 1**).



Figure 2: Laser light beam guides that assist with determining correct patient positioning.

Table 1. Common Panoramic Positioning Errors

Error	Cause	Corrective action	Tips for pediatric patients
Anterior teeth narrow Severe posterior overlap Vertebrae superimposed over condyles	Arches positioned too far anterior	Position anterior teeth in appropriate position on bite guide. Locate appropriate position with anterior laser light guide.	Use a cotton roll to fill in missing primary teeth or partially erupted permanent teeth. Adapt adult recommendation for direction of laser light beam guide for use with primary teeth. Observe laser light beam guide on both the right and left sides.
Anterior teeth wide, blurred out of image Condyles not imaged	Arches positioned too far posterior		
Teeth on the right side appear narrowed, severely overlapped Teeth on the left side appear broad, poorly defined Condyles asymmetrical in width and height	Arches tipped or tilted to the right	Position the midsagittal plane perpendicular to the floor.	Use laser light beam guide to locate midsagittal plane. Direct patient focus to mirror reflection. Affix decal to mirror to aid patient in maintaining the correct position throughout exposure.
Teeth on the left side appear narrowed, severely overlapped Teeth on the right side appear broad and poorly defined Condyles asymmetrical in width and height	Arches tipped or tilted to the left		
Flat, downward-turned, "frown" appearance to the occlusal plane Palate appears as a widened, thick, dense radiopacity Condyles flare out off the edges of the image Anterior teeth appear wide, elongated	Arches positioned too far superior	Position the Frankfort or the cantomeatal plane parallel to the floor, or the ala-tragus line 5° down toward the floor.	Move chin rest into a position that is slightly higher than the patient's chin height before requesting that the patient place chin onto the rest. Direct the patient to assume a position that resembles the erect stance of a soldier.
Exaggerated upward curve of the occlusal plane creating a "smile" appearance Hyoid bone superimposed over the mandible Condyles tilt inward Anterior teeth appear narrowed; elongated in the maxilla and foreshortened in the mandible	Arches positioned too far inferior		
Pyramid-shaped radiopacity superimposed over the anterior teeth	Patient in slumped position	Position the back and neck straight.	Direct the patient to stick out the chest while dropping the chin down. While holding the unit handles for stability, direct the patient to take a half step in toward the vertical column of the x-ray machine into a position that feels as if he/she is slightly leaning backward.
Radiolucent shadow of the commissure superimposed over the teeth, mimicking caries	Lips not closed around bite block	Position the lips around the bite block.	Direct the patient to keep the lips closed around the bite block during the exposure.
Radiolucency superimposed over the maxillary teeth apices	Tongue not placed against palate	Position the tongue flat against the roof of the mouth.	Direct the patient to swallow and note the flat position of the tongue. Request that the patient suck in the cheeks, pushing the tongue into the correct flat position against the palate and maintain this position throughout the exposure.

FEBRUARY 2009

Dimensions OF DENTAL HYGIENE

Anterior-Posterior Positioning Error

When the arches are positioned incorrectly in the anterior-posterior direction, distortion or ghosting of the anterior anatomy occurs. unerupted teeth in the anterior region may not be imaged on the radiograph if positioned outside of the focal trough. It is important to note that an error of only 3 mm to 4 mm in either direction will result in a significantly compromised image.¹¹ When the arches are positioned too far anterior, the anterior teeth will appear narrow and diminished in size. The vertebrae of the spinal column may be superimposed over the condyles at the edges of the film and, depending on the size of the child, may be superimposed over the rami of the mandible blocking a clear view of the posterior teeth (**Figure 3**). When the arches are positioned too far posteriorly, the anterior teeth will appear broad or widened. If the position is excessively posterior, anterior teeth may be completely blurred from the image and the condyles may be cut off from the edges of the film.



Figure 3: Incorrect position too far anteriorly. Note the narrow anterior teeth and superimposition of the spinal column over the condyles. The radiolucency superior to the maxillary apices indicates that the tongue was not placed against the palate. An open lip line can also be detected.

To avoid these imaging errors, the anterior teeth must occlude edge-to-edge onto the designated area of the bite block. Achieving this position is easily compromised during exfoliation of primary teeth, making precise occlusion difficult when one tooth or multiple teeth are missing or partially erupted. A cotton roll may be attached to the bite block to fill in the space created by the missing tooth or teeth. Additionally, an adjustment may be necessary when using a laser light beam guide. The manufacturer's instructions for directing the laser light beam at a predetermined tooth or interproximal space usually apply to adult patients. These instructions may need to be modified for the pediatric patient with primary or mixed dentition.

Lateral Left-Right Positioning Error

When the arches are positioned incorrectly in the lateral left-right dimension, the posterior teeth on one side will appear broad or widened, while the teeth on the other side will appear narrowed or diminished in width and severely overlapped (**Figure 4**). This image distortion is like that which occurs with an incorrect anterior-posterior position. When the arches are rotated or tilted, the posterior teeth on one side move out of the focal trough to a position further away (back) from the image receptor, while the opposite side simultaneously moves closer (forward) to the image receptor. Depending on the severity of rotation or tilting, the inferior border of the mandible will appear distorted and the condyles and rami will appear asymmetrical.



Figure 4: Incorrect lateral position tilted to the right. Note the teeth on the left are wide and poorly defined, while the teeth on the right are narrowed and severely overlapped. The inferior border of the mandible is distorted and the condyles appear asymmetrical.

To avoid imaging errors that result from incorrect lateral positioning, the midsagittal plane must be positioned perpendicular to the floor. Most panoramic x-ray machines have a head positioner and/or laser light beam guide, along with a mirror, to assist in determining the correct lateral head position. The pediatric patient may need additional instructions to maintain the correct position throughout the exposure.

The movement of the tube head during exposure may pique the pediatric patient's curiosity, causing the head to rotate as the eyes follow the movement of the tube head. A vertical line decal affixed to the mirror can serve as a visual aid and a focus point. An eye-catching sticker, such as those purchased from a craft store, can be adhered to the mirror in a position that aligns with the midsagittal plane. The patient can be directed to position the head so that the sticker appears at the tip of the nose and to maintain focus on this reflection throughout the exposure. Pediatric patients may find looking at themselves in the mirror entertaining and a fun way to participate in the process.⁹

Superior-Inferior (Up-Down) Positioning Error

Positioning the dental arches within the superior-inferior (up-down) dimension of the focal trough can be difficult to achieve, especially with children whose smaller size reduces the distance between the shoulders and the inferior border of the chin. When the arches are positioned incorrectly in the superior-inferior direction, the image exhibits multiple distortions, including increased overlapping in the premolar regions. When the arches are positioned too far up or down, the teeth will simultaneously move into a position that is too far back or too far forward, respectively, out of the focal trough.¹¹

Positioning the arches too far superiorly produces a characteristic "frown" or flat, downward-turned appearance to the occlusal plane (**Figure 5**). The condyles flare out and off the edges of the image and the palate appears as a widened, thick, dense radiopacity. This positioning error results in a widened appearance of the palate and obliterates the apical regions of the maxillary teeth, compromising the images of the unerupted developing dentition. As the maxillary arch tips upward, the anterior teeth tilt backward producing the same widened appearance that results from an incorrect anterior-posterior position. Positioning the arches too far inferior produces a characteristic "smile" appearance or the upward curve of the occlusal plane, with the condyles tilting inward toward the center of the image (**Figure 6**). Depending on the severity of the downward position, the vertebrae may also curve inward and appear superimposed over the condyles, and the hyoid bone may be superimposed over the mandible blocking a clear view of the erupted and unerupted mandibular teeth.

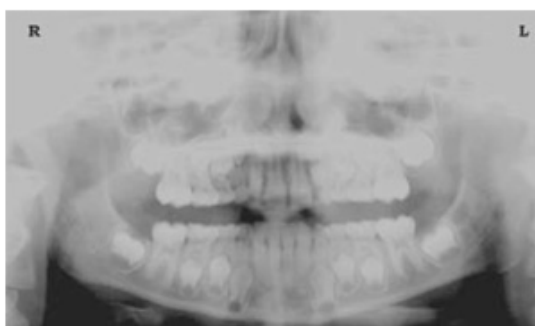

Figure 5: Chin positioned too far up. Note the characteristic "frown" or flat, downward-turned appearance to the occlusal plane. The widened palate obscures the view of the maxillary apices and the developing permanent dentition.

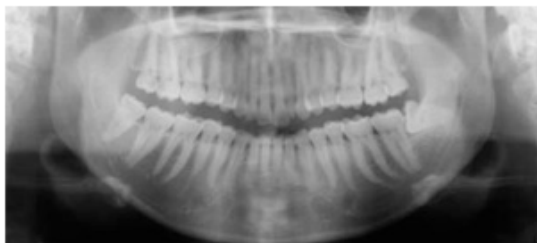

Figure 6: Chin positioned too far down. Note the characteristic “smile” or upward curved appearance to the occlusal plane and the hyoid bone superimposed over the mandible.

Correct positioning of the arches in the superior-inferior dimension requires that the patient stands with erect posture while tucking the chin in and down slightly, a direction that both adults and pediatric patients often find difficult to follow without specific guidance. The result is often a slumped position with the patient hunching the neck and shoulders over to place the chin on the chin rest. The vertebrae collapse causing attenuation of the x-ray beam that produces a triangular radiopacity superimposed over the mandible, and if severe, over the maxillary anterior regions as well.

Depending on the manufacturer, panoramic x-ray machines direct the operator to position the Frankfort or the canthomeatal plane parallel to the floor, or the ala-tragus line 5° down toward the floor. This is achieved by raising or lowering the chin rest so that the appropriate landmark lines up with indicators on the machine (**Figure 2**). The patient should be directed to stand in front of the panoramic x-ray machine allowing the operator to place the chin rest into a position that is slightly higher than the patient’s chin. The patient is then requested to move into the overhead assembly of the machine and remain standing tall. If further adjustment is needed, it is usually to a lowered chin position. Once the patient’s chin is resting on the chin rest, it is easier to move to a lower position than to a higher one. To assist with placing the chin on the chin rest while maintaining an erect posture, the pediatric patient can be directed to stand like a soldier. Most children are familiar with the straight back, chest forward tucked chin position demonstrated by military persons, and can readily mimic this stance.

Further Recommendations

Before beginning the exposure, the patient should be directed to close the lips around the bite block and to place the tongue against the palate. Leaving the lips open will create a soft tissue shadow across the teeth that can be mistaken for caries.⁷ Leaving the tongue at rest during the exposure allows the radiation to easily penetrate the space of the oral cavity between the dorsal surface of the tongue and the palate,

producing a radiolucent shadow that diminishes the diagnostic quality of the radiograph (Figure 3).

"Filling in" this space with the soft tissue of the tongue can increase the quality of the image by diminishing this radiolucent shadow. When directed to place the tongue on the roof of the mouth, the pediatric patient is likely to press only the tip of the tongue against the palate. While an adult patient can usually understand what is required when directed to swallow and note the position of the tongue, a child may be directed to suck in the cheeks, which results in pushing the tongue into a position flat against the palate.⁷

Conclusion

In addition to these guidelines for producing error-free radiographic images for pediatric patients, panoramic machines should be evaluated periodically for accuracy. Changes may occur over time to the focal trough that interferes with the diagnostic quality of the machine.⁶ If a decrease in image quality is noted despite following accurate patient positioning steps, the panoramic x-ray machine should be inspected, and the focal trough recalibrated. The dental hygienist who is skilled in understanding panoramic equipment operation and pediatric patient management is more likely to produce radiographic images that result in higher diagnostic yields.

References

1. Public Health Service, Food and Drug Administration, American Dental Association Council on Dental Benefits Program, Council on Dental Practice, Council on Scientific Affairs. *The Selection of Patients for Dental Radiographic Examinations*. Washington, DC: United States Department of Health and Human Services; 1987 (revised 2005):1-23.
2. Pinkham PS, Casamassimo, Fields HW, McTigue DJ, Nowak AJ. *Pediatric Dentistry Infancy Through Adolescence*. 4th ed. St. Louis: Elsevier Saunders; 2005:677.
3. Thomson EM. *Panoramic radiographs and the pediatric patient*. *Dimensions of Dental Hygiene*. 2008;6(2):26-29.
4. Rushton VE, Rout J. *Panoramic Radiology*. London: Quintessence Publishing Co Ltd; 2006:17, 84-85.
5. Kullman L, Joseph B. *Quality of digital panoramic radiography in a newly established dental school*. *Swedish Dent Journal*. 2006; 30: 165-170.
6. Akarslan ZZ, Erten H, Güngör K, et al. *Common errors on panoramic radiographs taken in a dental school*. *J Contemp Dent Pract*. 2003;4:24-34.
7. Rushton VE, Horner K, Worthington HV. *The quality of panoramic radiographs in a sample of general dental practices*. *Br Dent J*. 1999; 26: 630-633.

8. White SC, Heslop EW, Hollender LG, Mosier KM, Ruprecht A, Shrout MK. *Parameters of radiologic care: an official report of the American Academy of Oral and Maxillofacial Radiology. Oral Surg Oral Med Oral Pathol.* 2001;91:498-511.
9. McDonald RE, Avery DR, Dean JA. *Dentistry for the Child and Adolescent. 8th ed. St. Louis: Elsevier Mosby; 2000:71-72.*
10. Johnson ON, Thomson EM. *Essentials of Dental Radiography for Dental Assistants and Hygienists. 8th ed. Upper Saddle River, NJ: Prentice-Hall 2007:388-397.*
11. Sherman N, Horrell BM, Singer, S. *High-quality panoramic radiographs. Tips and tricks. Dentistry Today.* 2003;22(1):70-73.

14.5.3 Setting Exposure Values to the Age Group

For more information about this topic, refer to the Appendices **15.1 Recommended X-Ray Exposure Table**.

14.5.4 The References Pertinent to the Potential Risks for the Pediatric Patients

1) Literature

- I. ESPELID, I. MEJÅRE, K. WEERHEIJM:
EAPD guidelines for use of radiographs in children, P40-48. *European Journal of Pediatric Dentistry* 1/2003
Guidelines in dental radiology is designed to avoid unnecessary exposure to X-radiation and to identify individuals who may benefit from a radiographic examination. Every prescription of radiographs should be based on an evaluation of the individual patient's benefit. Due to the relatively high frequency of caries among 5-year-old children, it is recommended to consider dental radiography for each child even without any visible caries or restorations. Furthermore, radiography should be considered at 8-9 years of age and then at 12-14, which is 1-2 years after the eruption of premolars and second molars. Additional bitewing controls should be based on an overall assessment of the caries activity/risk. The high-risk patient should be examined radiographically annually, while a 2-3 year interval should be considered when caries activity/risk is low. A routine survey by radiographs, except for caries, has not been shown to provide sufficient information to be justified considering the balance between cost (radiation and resources) and benefit.
- MICHAEL L. TAYLOR, B.SC. TOMAS KRON, PH.D., AND RICK D. FRANICH, PH.D.:

ASSESSMENT OF OUT-OF-FIELD DOSES IN RADIOTHERAPY OF BRAIN LESIONS IN CHILDREN, Int. J. Radiation Oncology Biol. Phys., Vol. -, No. -, pp. 1–7, 2010 To characterize the out-of-field doses in pediatric radiotherapy and to identify simple methods by which out-of-field dose might be minimized, to reduce the risk of secondary cancers Out-of-field doses to pediatric patients can be minimized by using simple treatment

2) Website

For additional information on pediatric X-ray imaging, please refer to the websites below.

- <http://www.fda.gov/radiation-emittingproducts/radiationemittingproductsandprocedures/medicalimaging/ucm298899.htm>
- <http://www.imagegently.org/>

14.6 Abbreviations

AC	Alternating Current
AF	Auto Focusing
AMPT	Adaptive layer Mode Panoramic Tomography
CAN	Controlled Area Network
CMOS	Complementary Metal-Oxide -Semiconductor
DAP	Dose Area Product
DC	Direct Current
DICOM	Digital Imaging and Communications in Medicine
EMC	Electromagnetic Compatibility
ESD	Electrostatic Discharge
EUT	Equipment Under Test
FDD	Focal spot to Detector Distance
FOD	Focal spot to Object Distance
FPD	Flat Panel Detector
IEC	International Electrotechnical Commission
ISO	International Standards Organization
LED	Light-Emitting Diode
MPSO	Multiple Portable Socket-Outlet
ODD	Object to Detector Distance
PA	Posterior / Anterior
RF	Radio Frequency
ROI	Region of Interest
SID	Source to Image Receptor Distance
SIP	Signal Input Part
SOP	Signal Output Part
SMV	Submento-Vertical
TMJ	Temporomandibular Joint
UHD	Ultra-High Definition

PaX-i Insight™ PaX-i Plus™