

EzSensor Soft™

(EzSensor Soft / Soft i / Bio / Bio i)

Installation & User Manual

Version : 1.4

- English



Full version

vatech

Contents

CHAPTER 1 INTRODUCTION	1
1.1 Notice.....	1
1.2 Conventions and Symbols.....	1
1. Convention	1
2. Symbols Descriptions	2
1.3 Safety Instructions	3
1.4 Disposing of the Product	6
CHAPTER 2 SYSTEM OVERVIEW	7
2.1 System Description	7
2.2 Product Components	9
CHAPTER 3 INSTALLATION	10
3.1 PC Specifications	10
3.2 Installation of Software Driver	11
3.2.1 EzSensor Soft Driver Setup	11
3.2.2 Cable connection & Driver Installation.....	13
3.3 Installation of the <i>EzSensor Soft</i> Holder.....	15
CHAPTER 4 IMAGE ACQUISITION BY USING <i>EASYDENT</i>.....	16
4.1 Installation of Easydent.....	16
4.2 Image Acquisition Overview	21
4.3 Running the EasyDent.....	22
4.3.1 Patient Registration and Device Selection.....	22
4.3.2 Single Shot	24
4.3.3 Multi-Shot.....	28
4.3.4 Sequence Shot	32

CHAPTER 5 IMAGE ACQUISITION BY USING EZDENT-I.....35

5.1 Installation EzDent-i35

5.2 License Activation.....41

5.3 Consult DB License Activation.....44

5.4 Preparing for Image Acquisition47

5.5 Running the EzDent-i.....48

 5.5.1 Patient Registration 48

 5.5.2 Acquiring Image..... 49

 5.5.3 Image View..... 54

CHAPTER 6 MAINTENANCE55

6.1 Visual Inspection55

6.2 Periodic Maintenance.....55

 6.2.1 Test List 56

 6.2.2 Connection 56

 6.2.3 Cable 57

 6.2.4 Resolution..... 57

6.3 Care and Cleaning58

6.4 Precautions58

6.5 Product complaint59

CHAPTER 7 WARRANTY55

APPENDIX62

A.1 LED Indicators62

A.2 X-ray Exposure Guide63

A.3 Error Message.....65

A.4 Troubleshooting67

A.5 Electromagnetic Compatibility Information.....68

Chapter 1 Introduction

1.1 Notice

For the improvement of Product performance, supplementation, and the follow-up of information, the contents of this manual are subject to change without prior notice.

Please note that our company bears no responsibility for accidental damage nor will we be obligated to provide warranty service for any damage to equipment due to user error. Please follow the instructions in this manual closely. Become familiar with the safety precautions and usage procedures for this Product. Note that the Product may differ slightly from the contents of this manual, depending on individual Product specifications.

1.2 Conventions and Symbols

1. Convention

The following symbols are used throughout this manual to provide instructions on the effective use of this Product.



Indicates useful information and tips on how to use our software and Products.



CAUTION

Indicates important instructions. If not observed, malfunction or damage to the Product or other property may occur.









WARNING

Indicates warnings and safety instructions. If not adhered to, there is a serious risk of injury to the patient and/or the operator.

For U.S.A. users: United State federal law restricts this device to use by or on the order of a physician.

For other countries users: This device to use by or on the order of a licensed person under the related laws in each country.

2. Symbols Descriptions

Item	Symbol	Description
1		Type B applied part
2		Refer to instruction manual/ booklet
3	CE0120	Conforms to CE MDD 93/42/EEC (European Communities) concerning medical devices
4		Waste Electrical and Electronic Equipment
5		Manufacturer
6		Date of manufacture
7	SN	Serial number
8	EC REP	Authorized representative in the European Community
9		Handling procedures for Electro-Static Discharge (ESD).
10		Handle with care
11		Fragile, handle with care
12		This way up
13		Intended for a single use.

1.3 Safety Instructions

Indications for Use

***EzSensor Soft*, an Intra-oral Imaging device, is intended to collect dental x-ray photons and convert them into electronic impulses that may be stored, viewed, and manipulated for diagnostic use by dentists.**



Before each usage, check the outer surface of the ***EzSensor Soft*** for any signs of physical damage or defect. The surface of the ***EzSensor Soft*** should have a smooth finish, with no evidence of chipping or damage. Otherwise, contact your local Product distributor for further instructions on how to proceed.



To ensure the correct usage of the ***EzSensor Soft*** device in a clinical environment, for which the intended purposes correspond to its design and application, only dentists or their designated operators are authorized to operate this Product



Modifications and/or additions to the device must be conducted exclusively by MANUFACTURER or by parties expressly authorized to do so by MANUFACTURER. Any modifications or additions must always comply with the standards and generally recognized rules of good workmanship.



Please dip the sensor in either of the cleaning solutions listed above **6.3 Care and Cleaning** for less than 60 seconds. After immersing the sensor in disinfectant, use a dry cloth to wipe the sensor, Use of another disinfectant may cause discoloration, but will not cause dysfunction of the sensor.

It is the user's responsibility to ensure compliance with all local safety regulations in effect in the jurisdiction of installation.

Important Notice for Usage

EzSensor Soft minimizes patient's pain naturally through its capability to flexibly bend in conformity with the patient's arch shape.



CAUTION

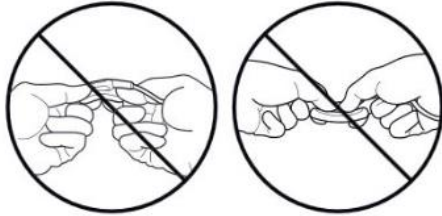

CAUTION

Bending or twisting the Product beyond its bending capability can shorten its useful life.

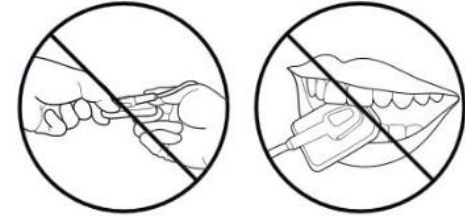

CAUTION

Intentionally biting on the Product can shorten its life.



CAUTION

There is a risk of cable breakage when excessive force is applied while pulling down or holding the sensor cable.

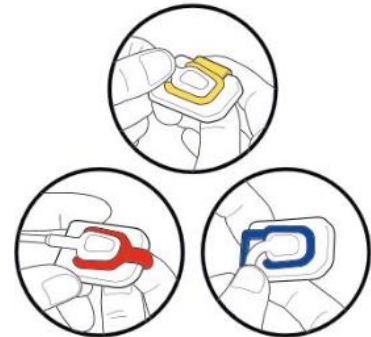

RECOMMENDATION

Please use the sensor holder provide with EzSensor Soft to avoid damage the sensor and better positioning.

Electrical safety



CAUTION

The covers of the Product may be removed only by qualified and authorized technical personnel.



CAUTION

This Product can only be used in rooms or areas that comply with all laws and regulations applicable to electrical safety on medical premises, such as IEC standards for the use of an additional ground terminal for equipotential connections. This Product must always be disconnected from the power supply before cleaning or disinfecting.



CAUTION

This Product should be connected to a PC which is complied with IEC or ISO safety standards.

Explosion safety



This Product is not recommended for use in the presence of flammable gases or vapors. Some disinfectants evaporate and form explosive or flammable mixtures. If disinfectants of this kind are used, it is important to let the vapors disperse before using the Product again. For the improvement of Product performance, supplementation, and follow-up of information, the contents of this manual are subject to change without prior notice.

X-ray protection



The rules of dental radiography apply to digital X-ray systems. Please continue to use protection for your patients. As a clinician, clear the immediate area when exposing the sensor.

1.4 Disposing of the Product

1. WEEE information according to Directive 2002/96/EC

(Waste Electrical and Electronic Equipment)



The crossed-out wheeled bin symbol, that is present on the Product, means that within the European Union the product must be taken to separate collection at the product end-of-life. Therefore, at the end of the life-cycle of the Product, the user



should deliver the device to the proper collection facilities of the Electric and

Electronic Equipment. Alternatively, the user can return the Product to the seller, on a one-to-one basis, as long as he or she is buying a new one of an equivalent type and that fulfills the same functions as the old one.

Disposing of the Product separately avoids possible negative consequences for the environment and health deriving from inappropriate disposal and enables the constituent materials to be recovered to obtain significant savings in energy and resources.

Who disposes of any Electric and Electronic Equipment, reporting the above symbol, as unsorted municipal waste, instead of collecting it separately, incurs the administrative sanctions in accordance with law.

2. Label Location

The label can be found on the **EzSensor Soft** device.

Chapter 2 SYSTEM OVERVIEW

2.1 System Description

This manual covers the installation and operating procedures of the ***EzSensor Soft, EzSensor Soft i, EzSeonsor Bio, EzSeonsor Bio i*** (“***collectively or individually referred to as EzSensor or Product***”).

Unless otherwise specified, all the information contained in this manual is applicable equally to all ***EzSensor Soft*** types.



The Product has to be installed, transported and stored in the permissible environmental conditions. Use the provided protective package for transporting or storage. Also, the Product should not operate in oxygen-rich or explosive environments.

<Table 1.Specifications >

Parameter	Description
Detector Structure	CMOS Photodiode Array
Dimensions (W x L x T)	Size 1.5: 1.60 x 1.20 x 0.30 inch (40.8 x 30.6 x 7.9mm) Size 2.0: 1.73 x 1.28 x 0.30 inch (44.0 x 32.5 x 7.9mm)
Pixel Pitch	High Resolution Mode : 0.0148 mm Normal Resolution Mode : 0.0296 mm
Active Pixel Array	Size 1.5: 1620 x 2230 pixels (23.98 x 33.00 mm) 810 x 1115 pixels @ Normal Resolution Mode Size 2.0: 1756 x 2432 pixels (25.99 x 35.99 mm) 878 x 1216 pixels @ Normal Resolution Mode
Grayscale	4096 gray levels
Resolution	High Resolution Mode : 33.78 lp/mm (theoretical) Normal Resolution Mode : 16.89 lp/mm (theoretical)
USB Cable length between Controller and PC	Under 3 m
Electrical rating	DC 5V, 500mA
Operation mode	Global shutter
Ambient Temperature	10°C to 30°C (Usage) -20°C to 60°C (Transportation and Storage)
Relative Humidity	30% to 95% (Usage) 10% to 95% (Transportation and Storage)
Air Pressure	700 to 1060 hPa
EU classification	Medical Devices 93/42/EEC as a class IIa
Protection against shock	Type B applied part
Protection against matter/water	IP 68

* Specifications are subject to be changed without prior notice.

2.2 Product Components

The **EzSensor Soft** device installer should check the following items listed in the table below before Product installation. If the serial numbers of the individual parts do not match, do not install the Product. Contact your local distributor or agent for support.

This Product should be connected to a device or product which is complied with IEC 60601-1.

<Table 2.**EzSensor Soft** Product components>

No	Components	Remarks
1.	Sensor Module*	2.8m USB cable is all in one
2	Wrap* (Hygienic Sleeves)	
3.	Holder of Sensor	
4	Silicon cover*	
5.	S/W Installation CD(or USB)	EasyDent (or EzDent-i)
6.	Driver Installation CD	USB Device Driver
7.	EzSensor Soft Manual	Document
8	Sensor Cradle	Option

* Patient applied part (Inside Patient environment)

Sensor Module:

Consists of a special CMOS sensor specifically designed for use in radiography and enclosed in a hermetically sealed ergonomic capsule. The sensitive surface of the sensor is covered with a thin layer of scintillating phosphorous, through which X-ray radiation is converted into light and then into an electric charge.



Wrap (Hygienic Sleeves)

The sensor is supplied in a non-sterile state. Single-use wrap must cover the sensor before placing it in the patient's mouth. The once used wrap shall be disposed. This conforms to the ISO 10993-1.

Chapter 3 INSTALLATION

3.1 PC Specifications

1. Recommended Server PC Specifications

- Workstation
- Operating System: Window 2000 server or higher
- RAM: 4GB or Higher
- HDD: 1TB or higher

2. Recommended Client PC Specifications

- CPU: Core DUO CPU 1.8GHz or Higher
- Main Memory: 2GB of Higher
- Graphics Card: 512MB or Higher
- HDD: 2GB free space
- Display: 1280x1024x32bpp

3. Operating System

- Window 34&64bit: XP(SP1), Vista, 7, 8, 8.1



We cannot guarantee that Easydent(EzDent-i) will work properly with an unregistered copy of Microsoft Windows. Therefore, you should use a registered, genuine version of Microsoft Windows.



Turn off the Windows Firewall service for proper communication across the network for the installed database and file servers.



If you need to install additional software on your computer, please install only those that are internationally authorized. Take extra precaution when installing any Active-X controls.

3.2 Installation of Software Driver



To operate the intraoral sensor, you need to install the EzSensor Soft Driver. This Product should be connected with the product or the device which is complied with IEC60601-1

3.2.1 EzSensor Soft Driver Setup

This step is necessary for the installation of **EzSensor Soft**. Capturing software and Calibration data for the **EzSensor Soft** will be installed and downloaded along with the Windows device driver. A Twain driver is also installed during this step.

Step 1

Insert the S/W Installation CD in the CD-ROM. Setup should start automatically.

If it does not, click **Start>Run** and type

Home directory:\Console\setup.exe

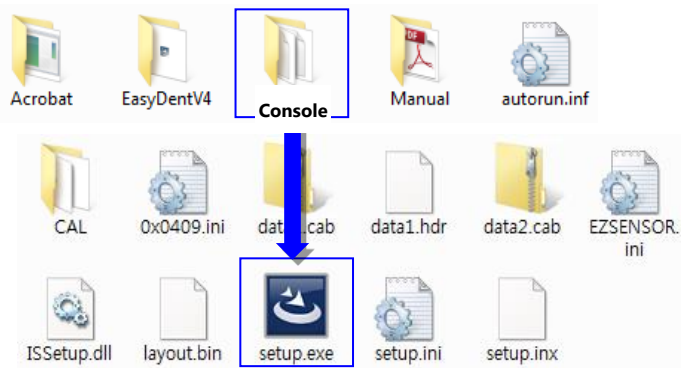

Step 2

The install program for 'IntraOral USB-Sensor Acquisition Software' will appear. Click the 'Next' button.

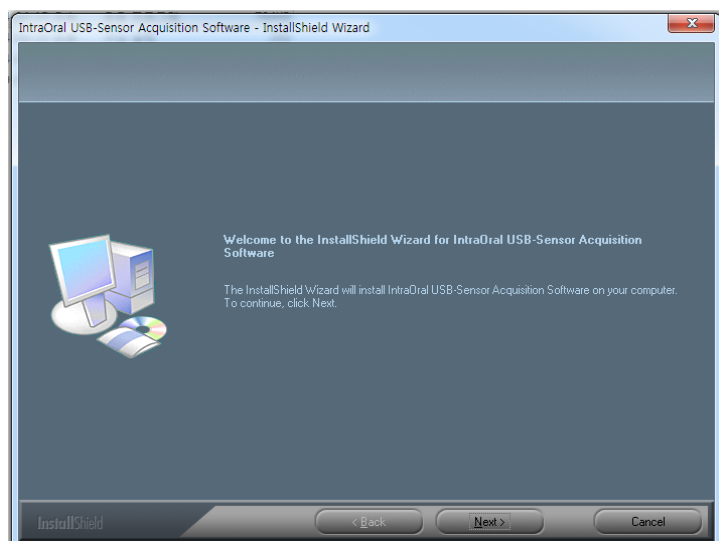

Step 3

Check the **EzSensor Soft** installation directory and then click the 'Next' button.

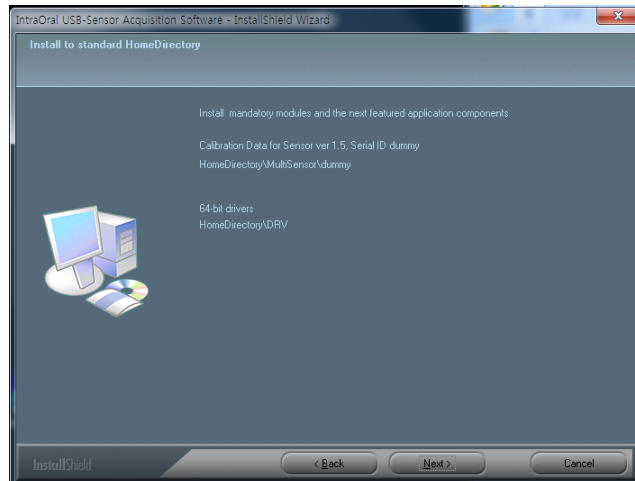

Step 4

The InstallShield Wizard will start configuring the installation parameters.

The Install-shield wizard will Copy the calibration files To your work-station (PC).

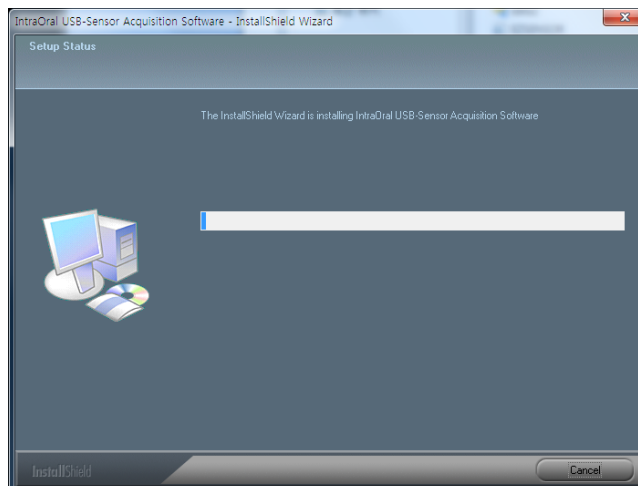

Step 5

The Install-shield wizard will be done.

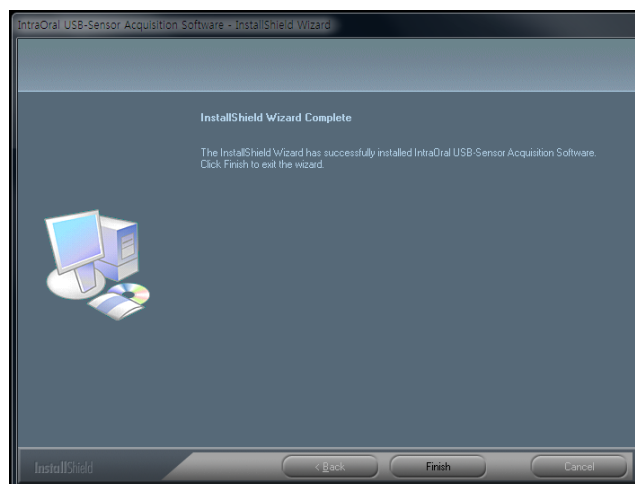

3.2.2 Cable connection & Driver Installation



Do not connect the EzSensor Soft and USB PC Interface cable to your computer until you have successfully installed the setup program.



Be sure to connect the EzSensor Soft module to the control board box before connecting the USB PC Interface cable to your computer.



Only connect the item that has been specified as part of the Medical Equipment System.

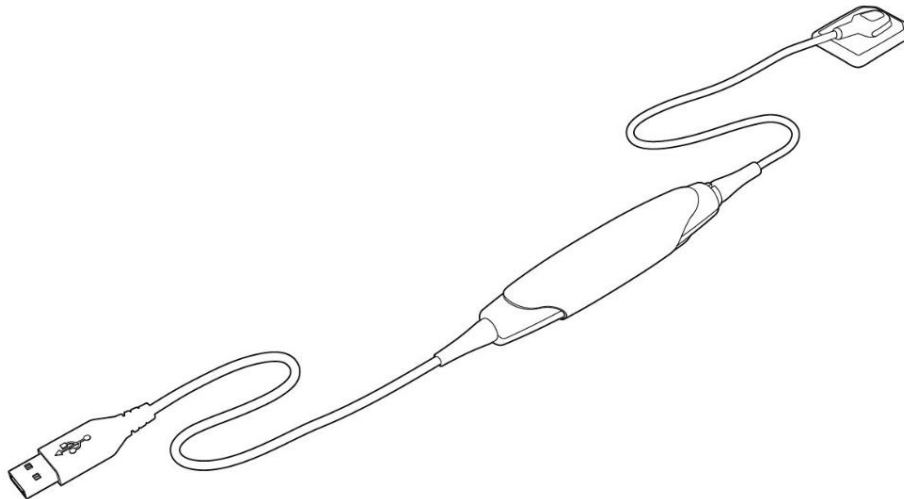

Step 1

Connect the **EzSensor Soft** USB Connector to the USB port on the PC directly.

Be sure to connect the USB port on the backside for accurate operation.

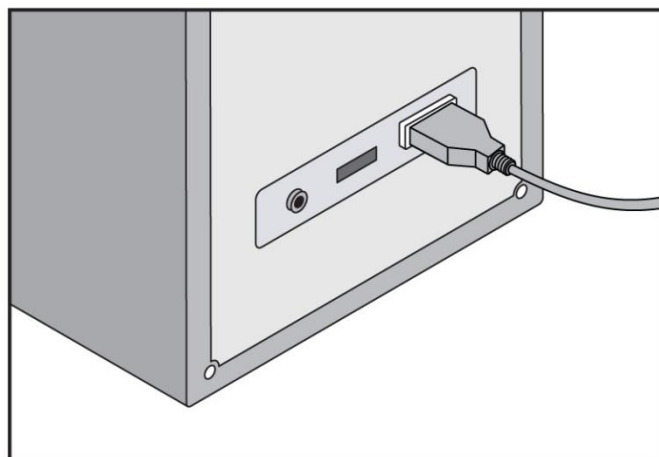

Step 2

Confirmation of Driver installation at the Device Manager.

Method of Confirmation:

Windows 7: Control Panel → System and Security → System → Device Manager

Windows XP: Settings → Control Panel → System → Hardware → Device manager

Select 'VH EzSensor-N x.x', located under Imaging Devices. You should see the message, "This device is working properly".

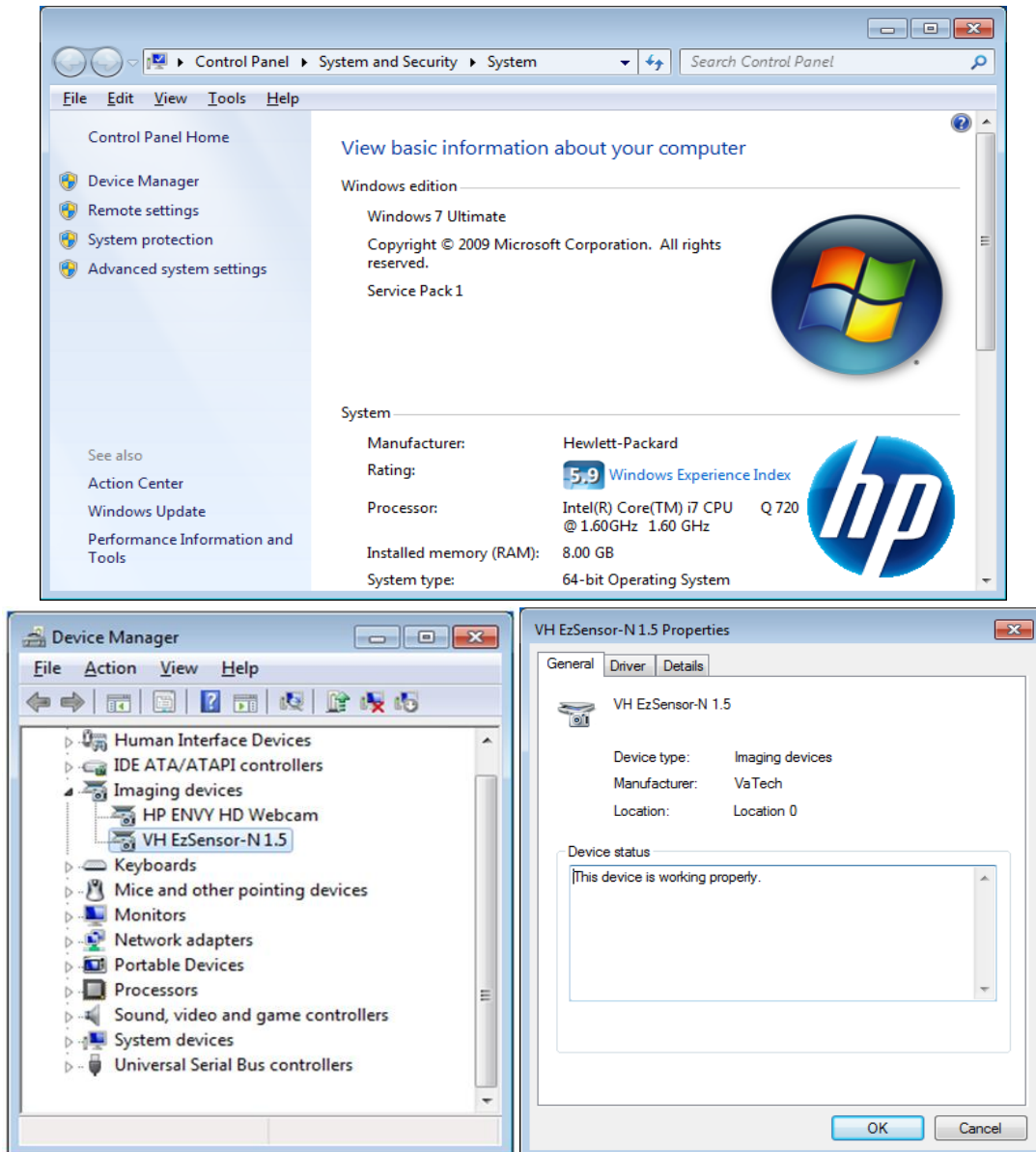

EzSensor Soft is supplied to the power and transports data via the USB port of the PC. Do not disconnect during usage.

3.3 Installation of the *EzSensor Soft* Holder

The *EzSensor Soft* holder is used for mounting the *EzSensor Soft* to the wall when not in use. When choosing where to install the *EzSensor Soft*, locate an area that offers easy access and visibility during patient examinations.

Position the holder on a stable, flat surface. Using the holes at the back of the holder as guides, fasten the holder securely to the wall using two drywall screws (included).

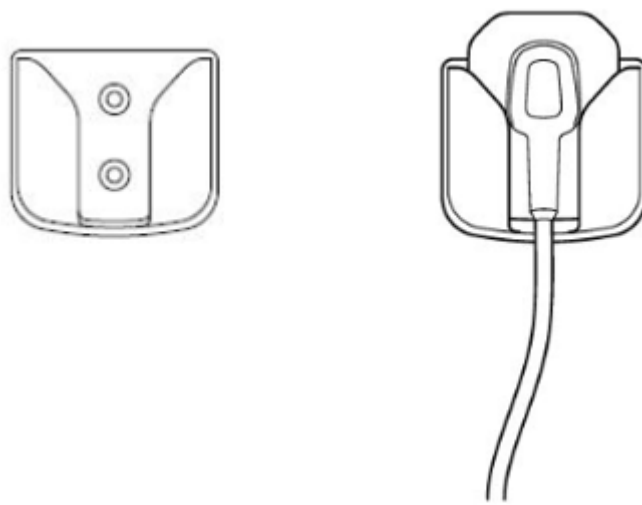

Optional Component

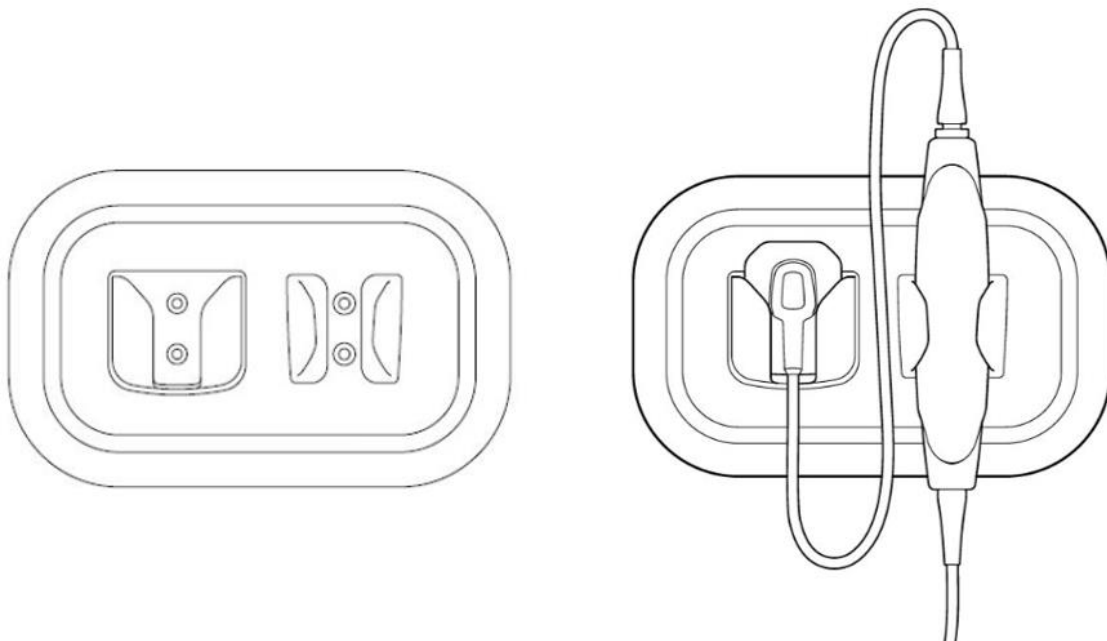

Chapter 4 Image Acquisition by using *Easydent*

4.1 Installation of Easydent

In this step, **Easydent** will be installed. Alternatively, software which supports the Twain interface can be used instead of **Easydent**.

Step 1

Insert the S/W installation CD in the CD-ROM drive.

Home

directory:\EasyDent\setup.exe.

Press 'Enter'.

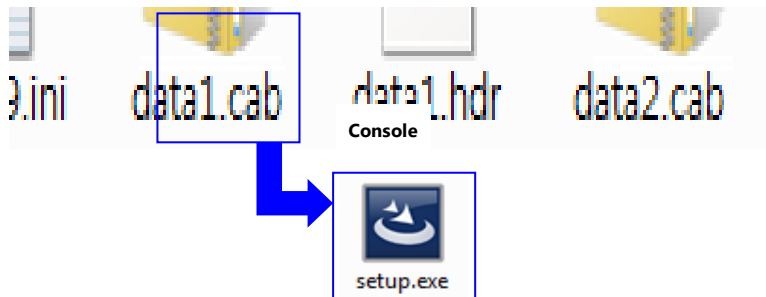

Step 2

Select the language you want to install and then click 'Next'.

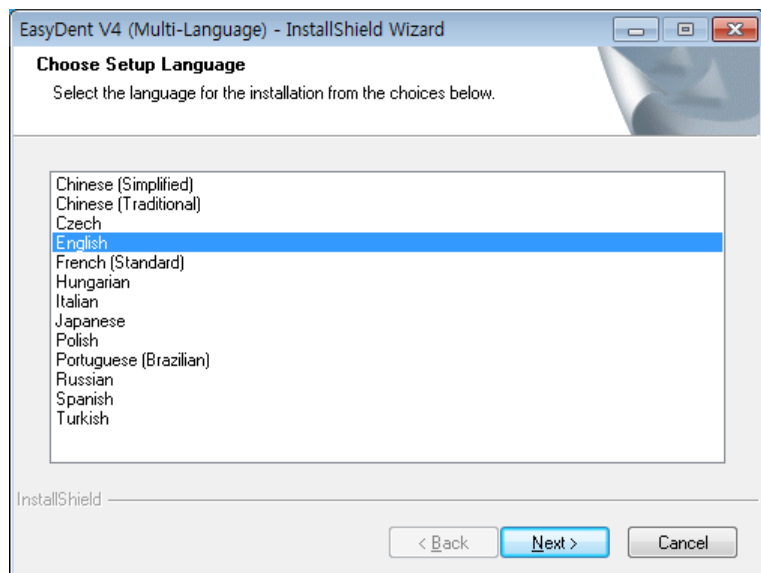

Step 3

The 'EasyDentV4 InstallShield wizard' will appear. Click the 'Next' button.

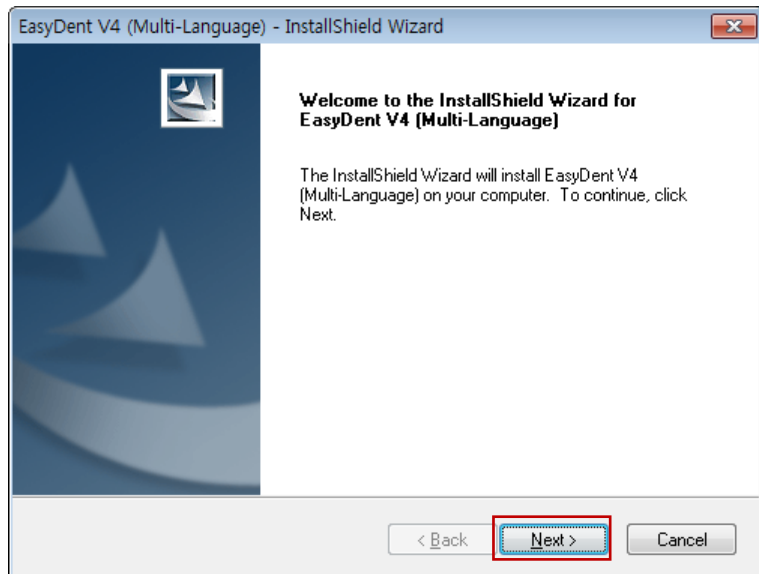

Step 4

Select the setup type that best suits your needs.
Click the 'Next' button.

Basic: Installs the basic version of EasyDent V4

CD-Publishing: Installs the basic version of EasyDent V4 along with CD-Publishing capabilities (optional)

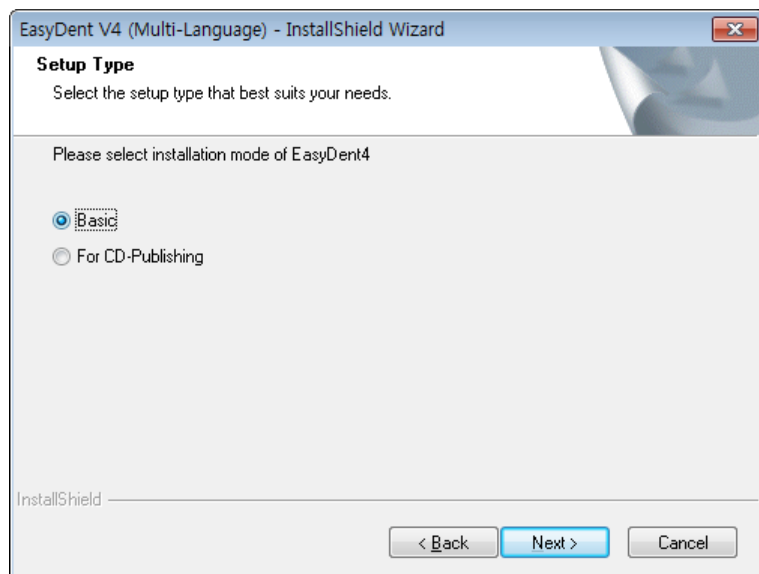

For the EasyDent server, select all items.

For PC being used for the viewer: Select only the items except for DB & File servers.

For the detailed installation, refer to the EasyDent installation manual.

Step 5

Select the features that you want to install. Click the 'Next' button.

EasyDent Viewer is the minimum requirement for **EzSensor Soft** use.

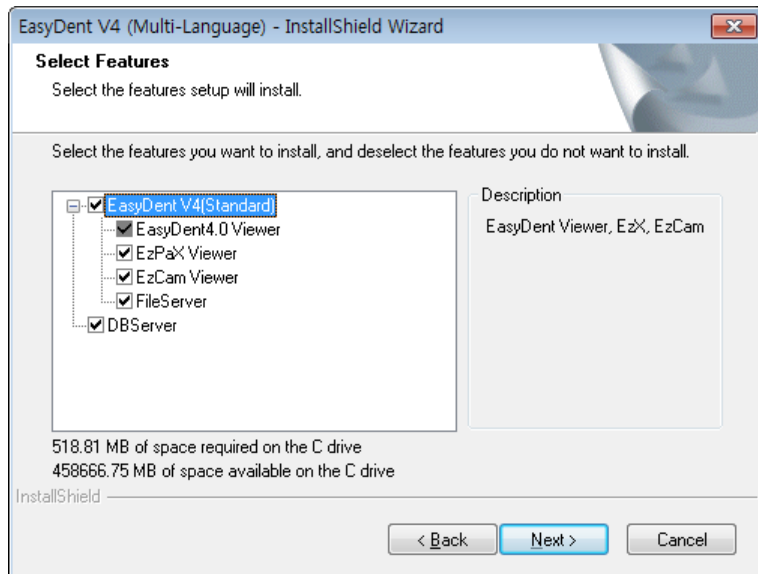

Step 6

Now you are ready to install. If you would like to review any of your installation settings, click 'Back'. To proceed with the installation, click 'Install'. Click 'Cancel' to exit the wizard.

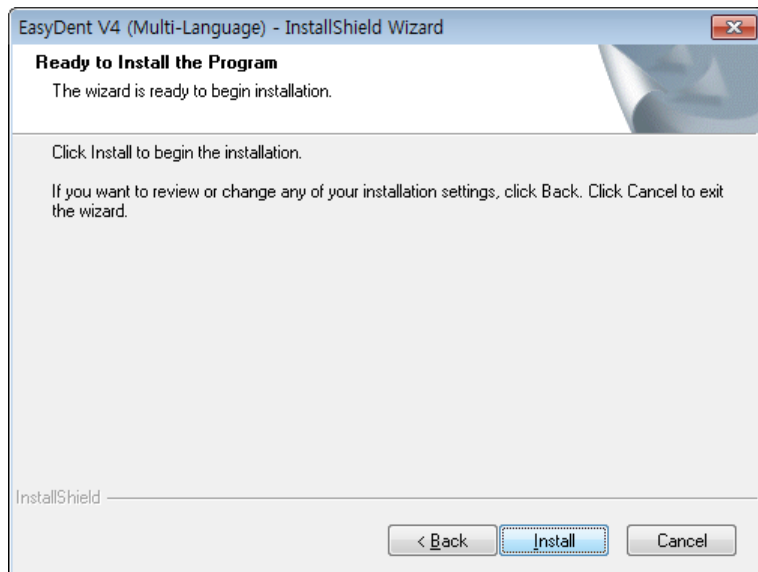

Step 7

Installing *EasyDentV4*

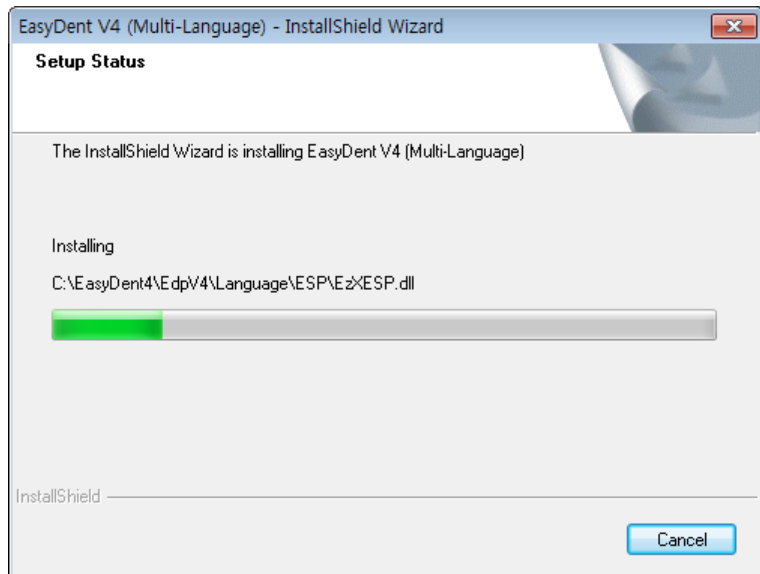

Step 8

The program compatibility and Windows Firewall alarm messages are shown.

Click 'Run program' button on the program compatibility message.

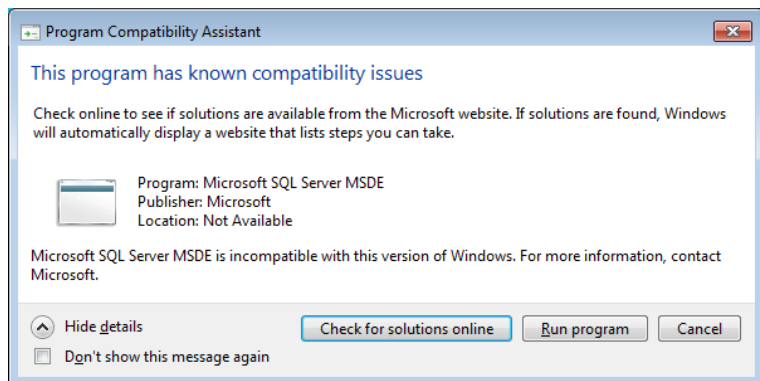

And click 'Allow access' button on the windows security message.

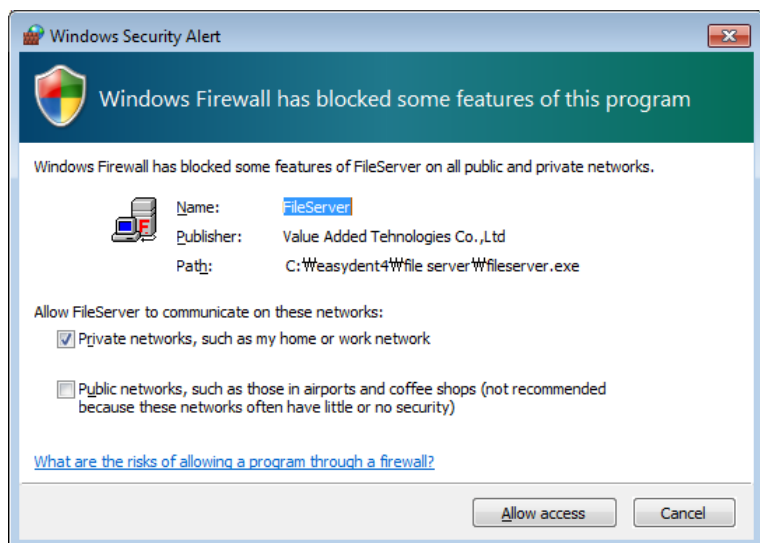

Step 9

MSDE(Microsoft SQL Server Desktop Engine) is installed automatically.
Close the SQL Server Service Manager.

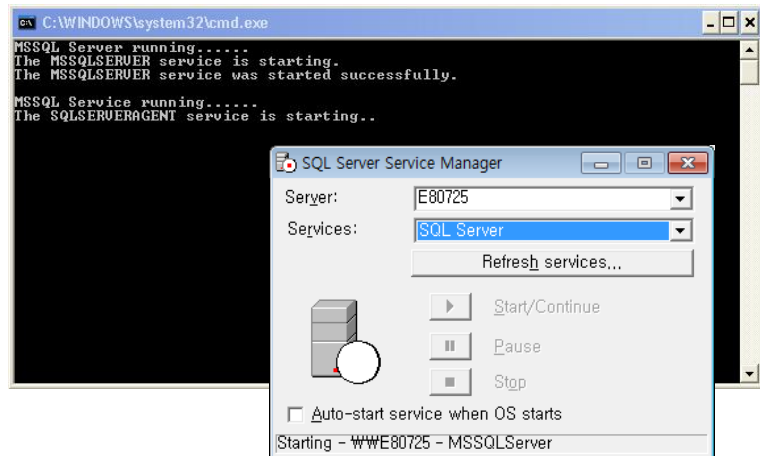

Step 10

Select 'No, I will restart my computer later', and then click 'Finish'.

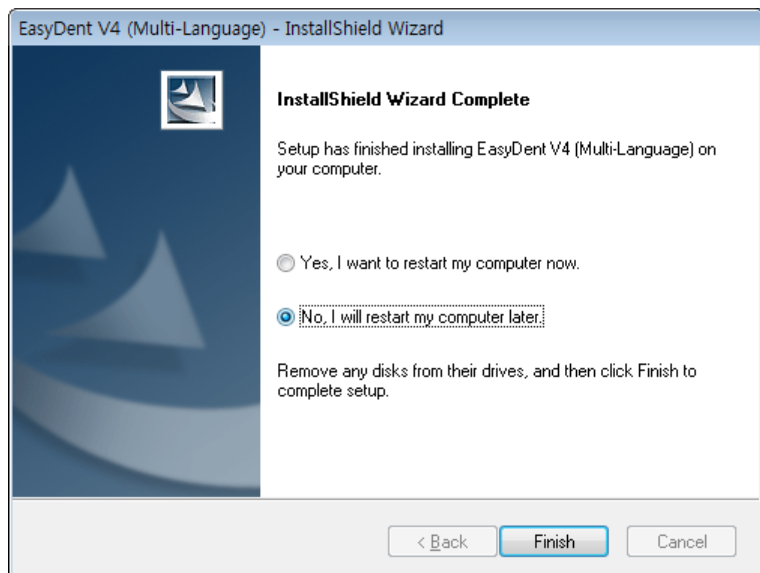

4.2 Image Acquisition Overview

- ① Turn on the computer.
- ② Run the EasyDent.
- ③ Configure the required X-ray parameters (exposure time, etc.) for the X-ray generator.
- ④ Before using the sensor, shooting the X-ray with putting the coin on the flat receptor of the sensor is recommend as an operation test.
- ⑤ Position the **EzSensor Soft** at the appropriate area in the mouth. The flat receptor side of the sensor must face the X-ray source. Note that the receptor side is marked with a label for ease of recognition
 The use of the sensor positioning aid is recommended to guarantee that the sensor is parallel to the tooth and is at the appropriate angle for exposure
- ⑥ The use of the parallel technique with a positioning system or device, if possible, is highly recommended.
- ⑦ After preparing the sensor for exposure, acquire an image by pressing the exposure button of your X-ray source.



Using the EzSensor soft

With intraoral X-ray



Using the EzSensor soft

with a Sensor positioning system(optional)



Normal Resolution Mode

This mode is typical operating and general usage and somewhat shows lower resolution, but gets the speed of data readout faster.

4.3 Running the EasyDent

Shot functions are available after patient registration and device selection. Single shot, multi-shot, sequence shot are used frequently. You must be fully aware of the explanations before capturing the image.

4.3.1 Patient Registration and Device Selection

Step 1

Turn on the PC.

Run EasyDent4 Viewer. Click the 'Patient ()' button to register a new patient.

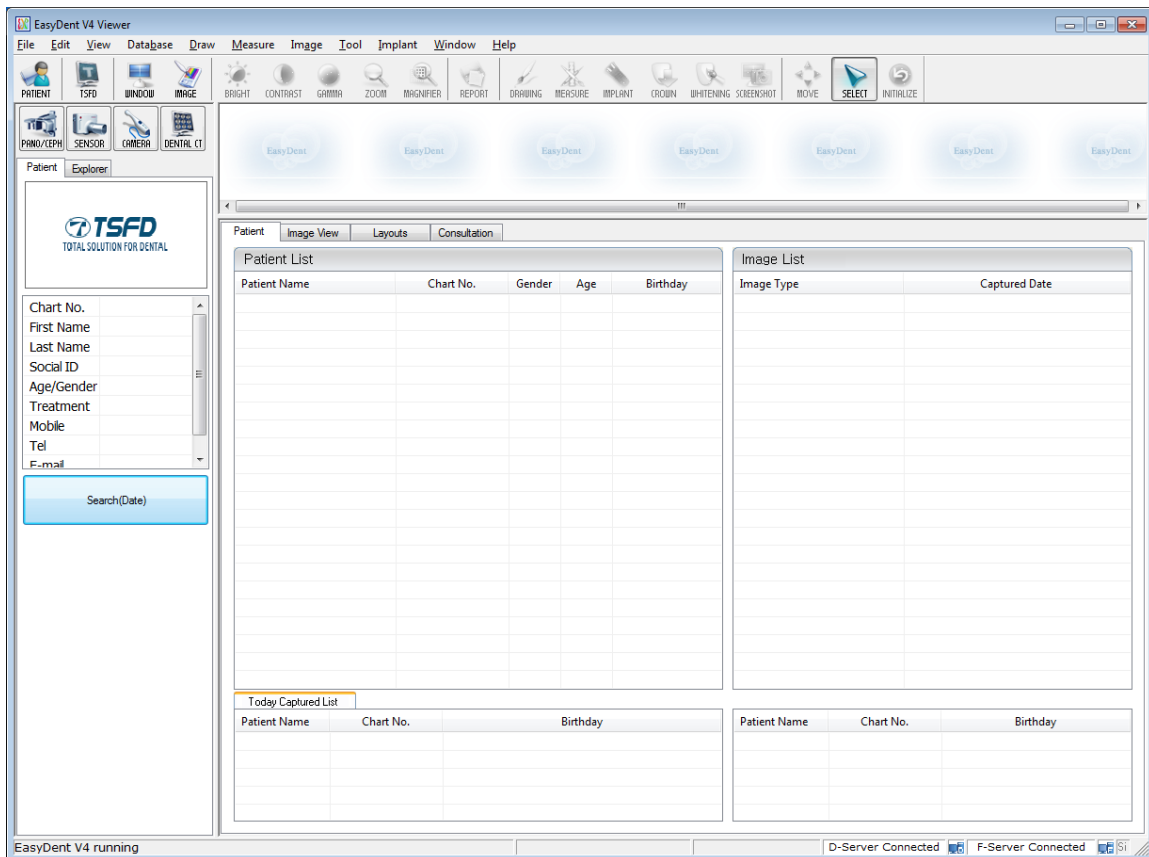

Step 2

The new patient registration window will appear. You are asked to register the new patient and click “Add”.

Step 3

Click ‘Help > Intra-Oral Sensor Setting > Select Device’ on the menu bar.

Select your capture device. At this time, you are asked to select the device and image quality.

The Product and image processing setting information is stored internally. Change these settings when using another sensor or changing the image processing option.

Level 4 is basic image processing option. As the level no. is higher, the effect of contrast and enhancement get increased.

- ① Level 1
- ② Level 2
- ③ Level 3
- ④ Level 4
- ⑤ Level 5
- ⑥ Level 6
- ⑦ Level 7

4.3.2 Single Shot

Capture a single image.

Step 1

Start EasyDent by clicking the EasyDent V4 Viewer on the desktop.
 Search and enter the appropriate patient information.

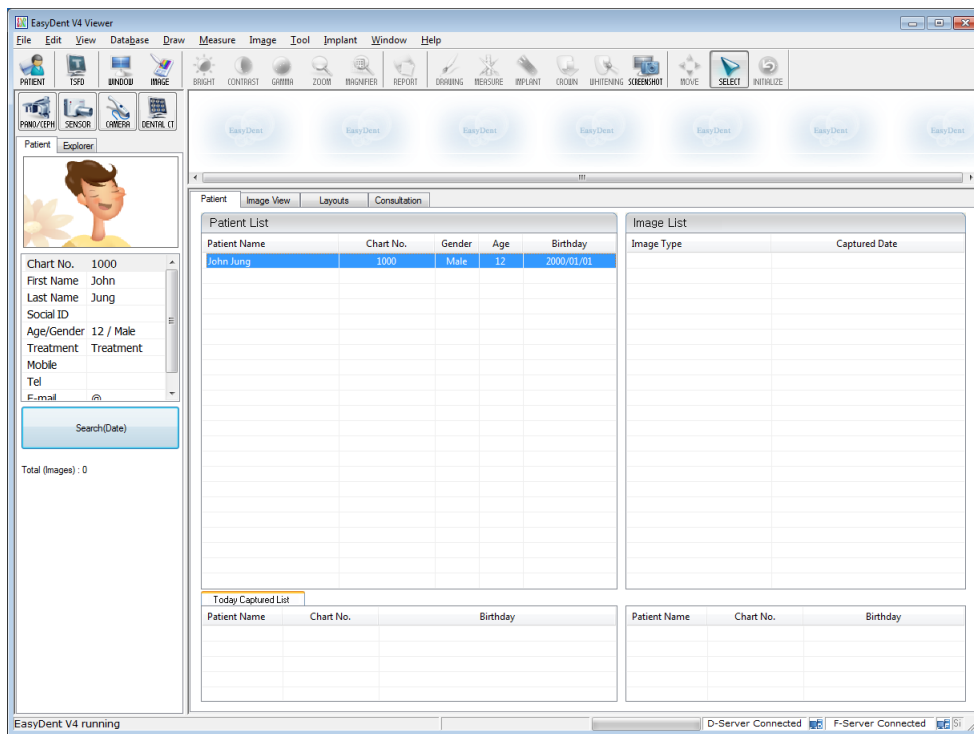

Step 2

Click the 'Layouts' tab. Select your favorite layout from the Layout template list. The Layout Template can be customized. Please refer to the EasyDent manual.

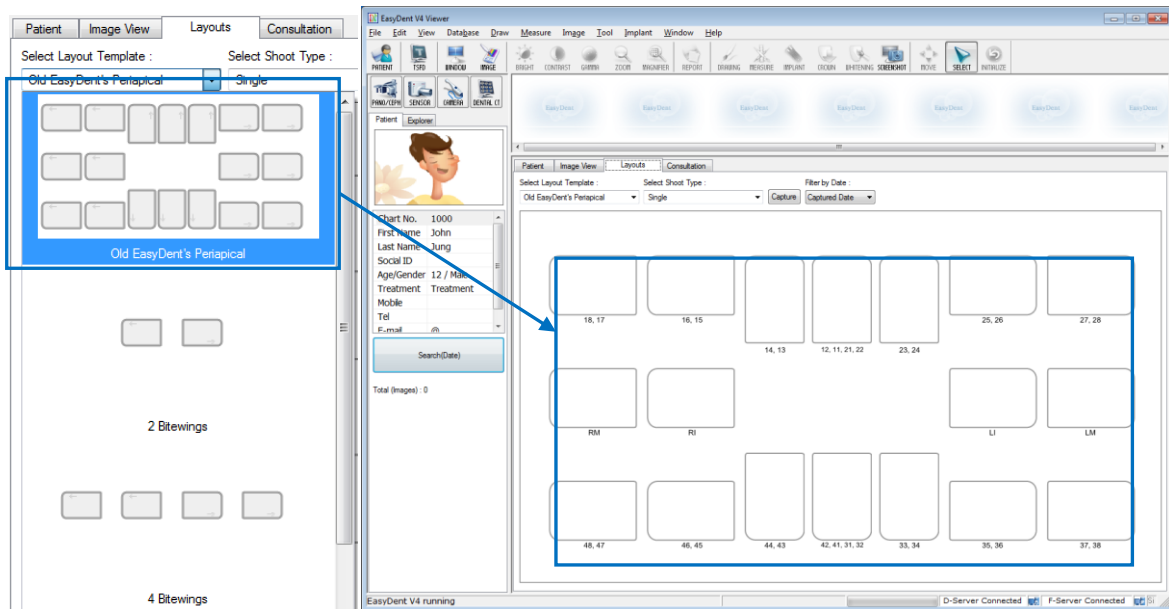

Step 3

Select the 'Single' from the Shoot Type list.

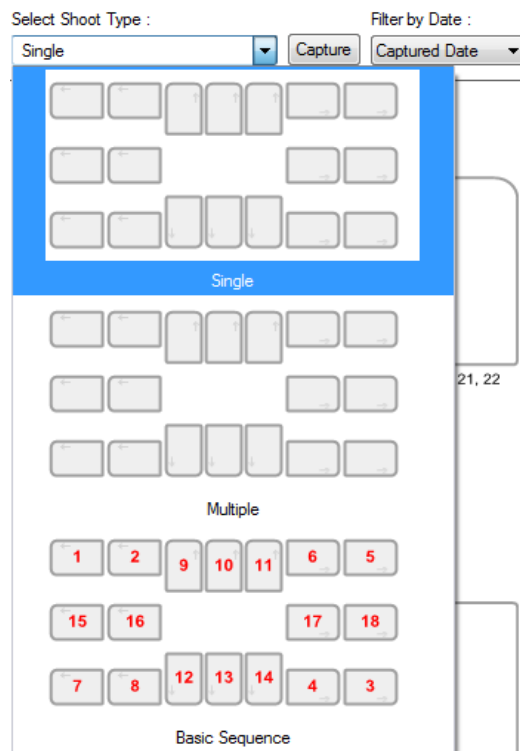

Step 4

Select the tooth position to capture. The tooth box is selected in blue.

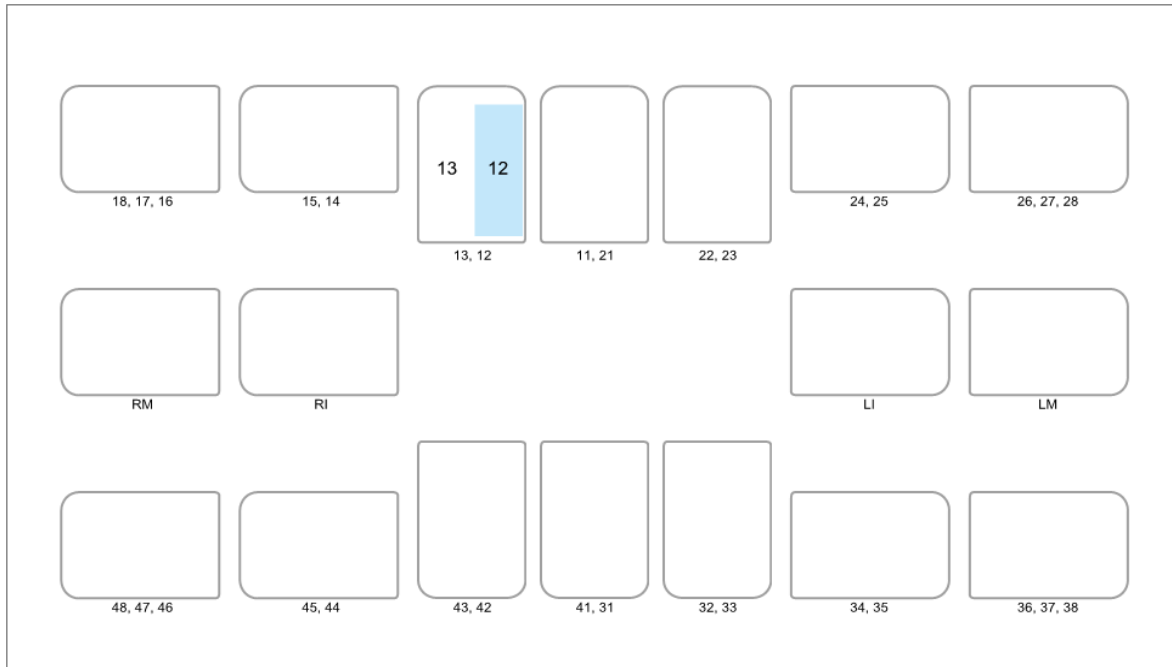

Step 5

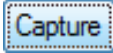
Click the 'SENSOR ()' button or 'Capture ()' button.

Step 6

Position the sensor correctly.

Step7

After checking the sensor is in the correct position, expose the X-ray after the “Please expose X-ray” message appears.

The message, “Optimizing Image... Please wait” appears while the image is being optimized. The image will appear after optimization is complete.

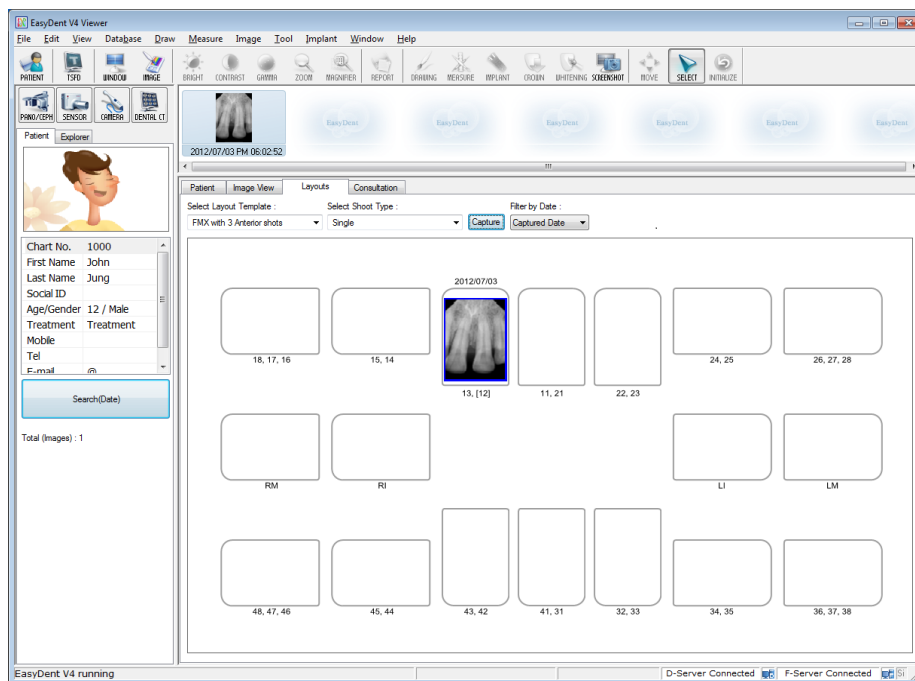
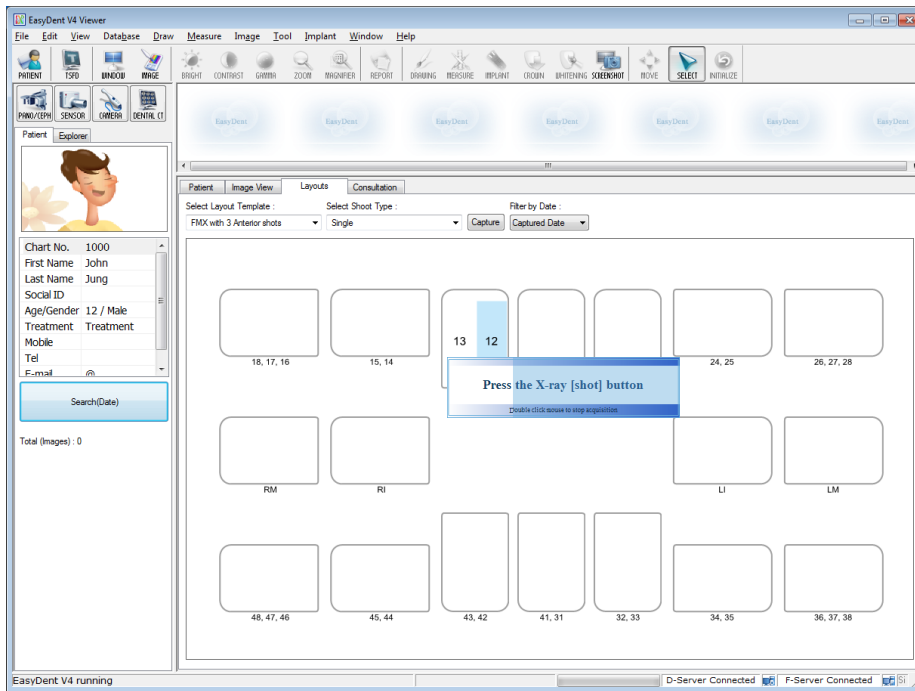

4.3.3 Multi-Shot

You can capture multiple images continuously until you click stop. Click and drag the image to its appropriate position after stopping the capture.

Step 1

Select the 'Multiple' from the Shoot Type list.

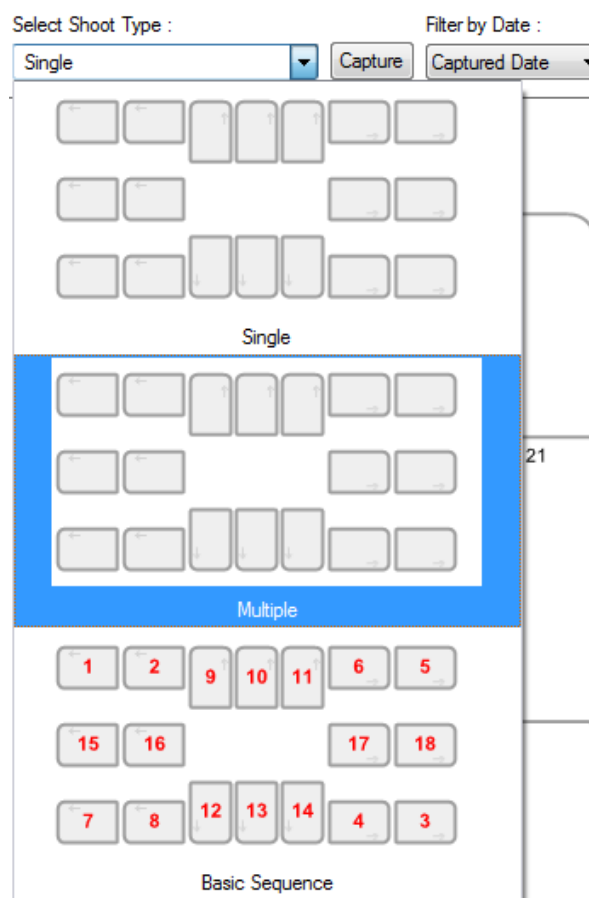

Step 2

Select the tooth position to capture. A blue rectangle will be drawn on the tooth box.

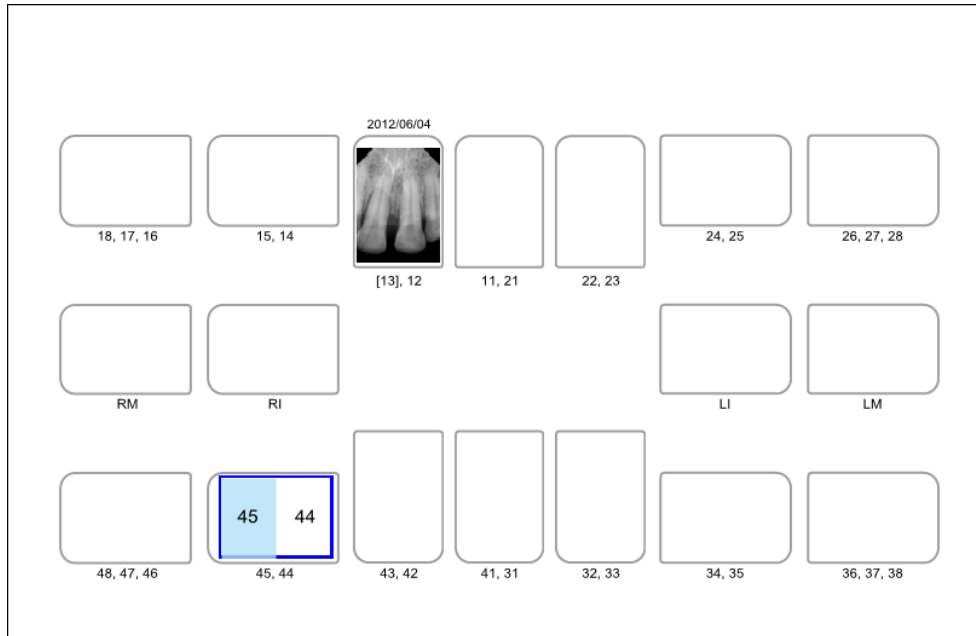

Step 3

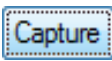
Click the 'SENSOR ()' button or 'Capture ()' button.

Step 4

Position the sensor correctly.

Step5

Expose the X-ray after the “Please expose X-ray” message appears.

The message, “Optimizing Image... Please wait” appears while the image is being optimized.

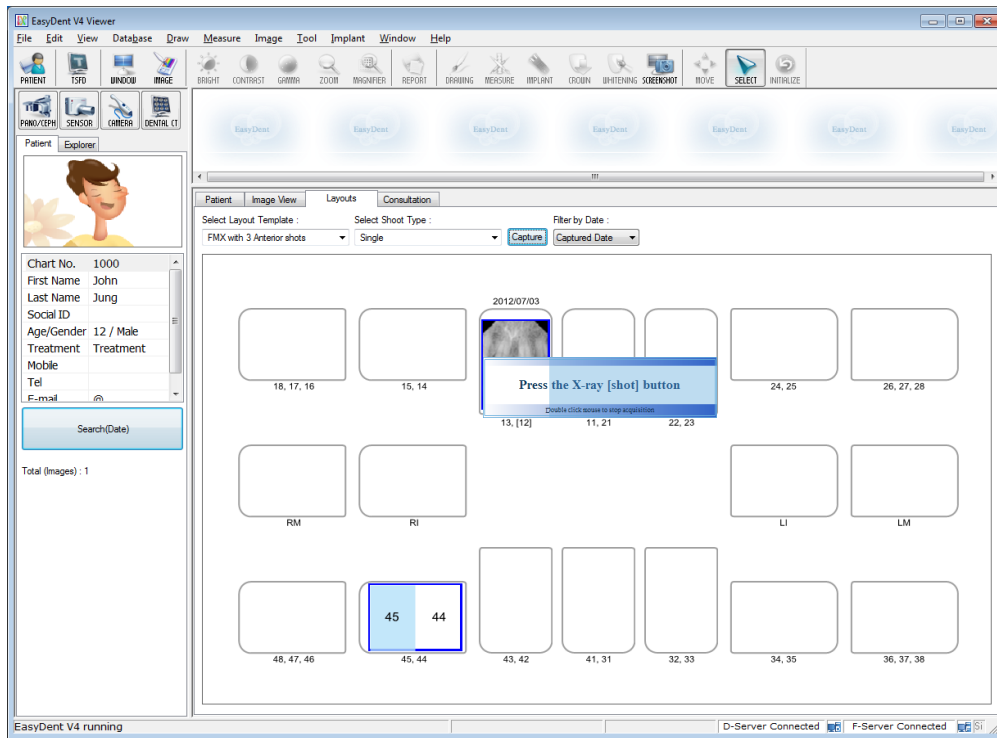

Step 6

If you want to acquire more images, continue to expose the x-ray when the 'Press the X-ray (shot) button' message appears.

To finish, double-click on the 'Press the X-ray (shot) button' message box. And then the image will appear after optimization is complete.

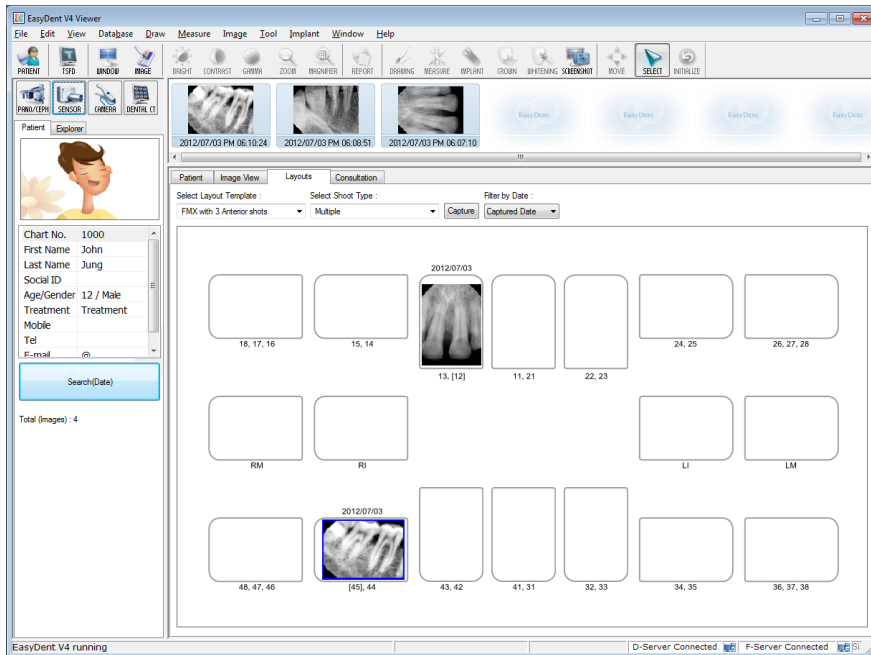

Step 7

Click and drag the image to its appropriate position.

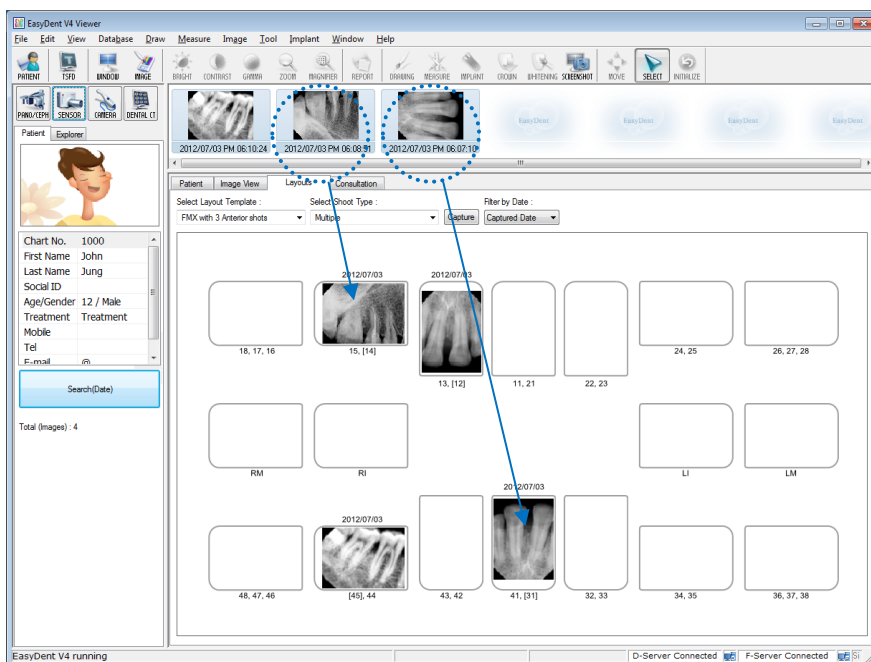

4.3.4 Sequence Shot

You can capture multiple images according to a pre-saved order. Capturing according to the order will ensure the images appear automatically in the correct positions.

Step 1

Select your favorite sequence from the Shoot Type list. Red numbers represent the capture order.

The Sequence shot can be customized. Please refer to the EasyDent manual.

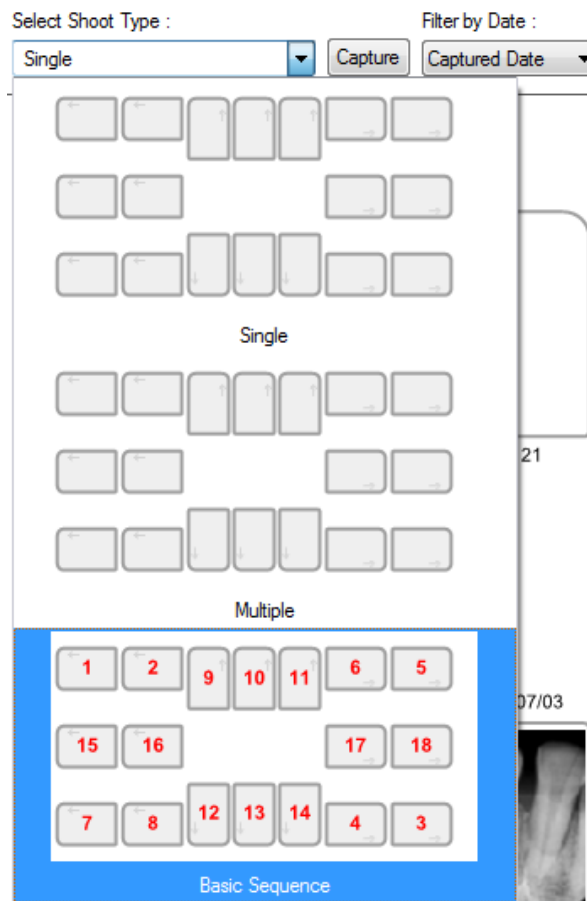

Step 2

Click the 'SENSOR ()' button or 'Capture ()' button.

Step 3

Position the sensor correctly.

Step 4

Capturing according to the order, the images appear automatically in the correct positions. Expose the X-ray after the “Please expose X-ray” message appears. The message, “Optimizing Image... Please wait” appears while the image is being optimized.

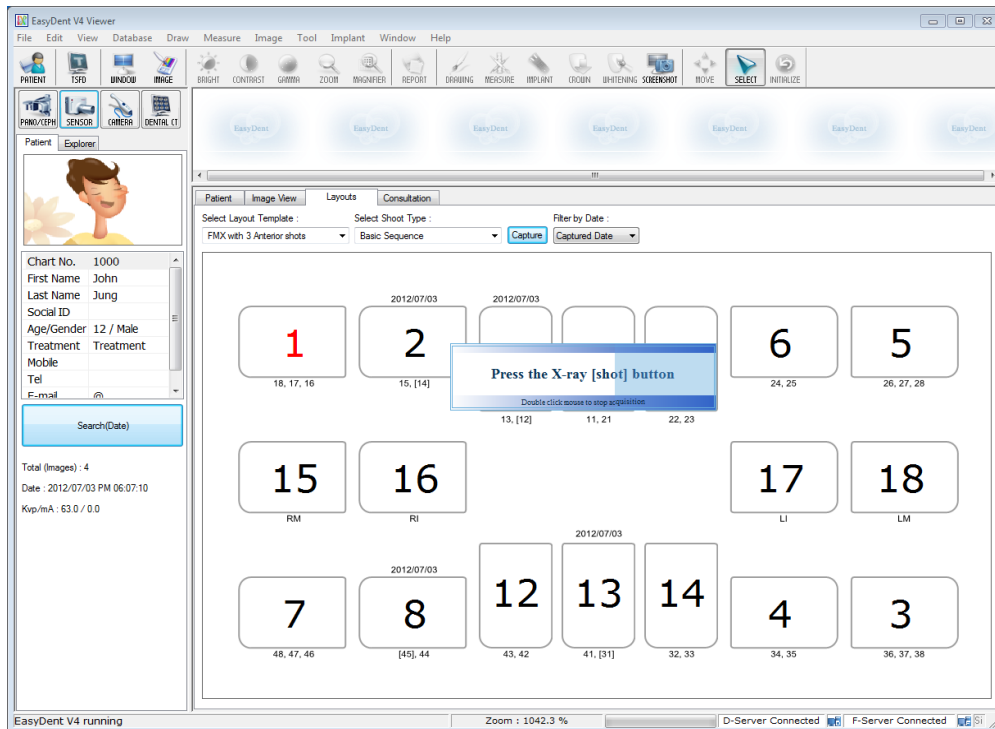

Step5

If you want to finish, double-click the 'Press the X-ray (shot) button' message box. And then according to the capturing order, the images appear automatically in the correct positions.

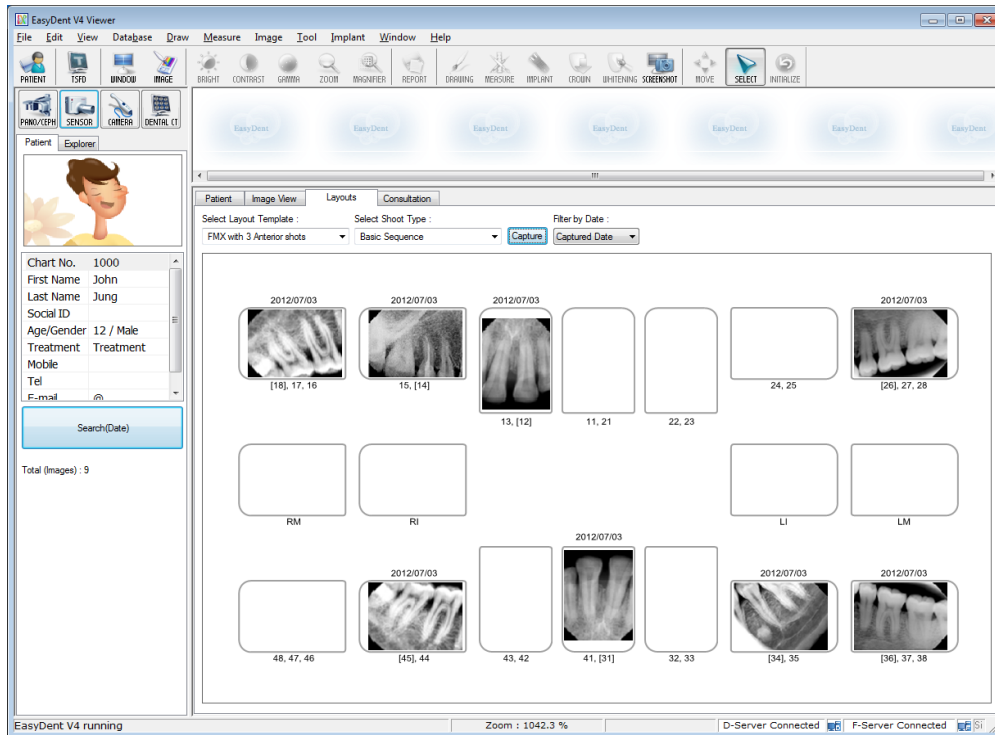

All images are saved in the Database server automatically.

By double-clicking on the image, the image is shown as large size at any function's table.

Chapter 5 Image Acquisition by using *EzDent-i*

5.1 Installation EzDent-i

In this step, *EzDent-i* will be installed. Alternatively, software which supports the Twain interface can be used instead of *EzDent-i*.

Step 1

Open [Setup.exe] from [Setup] folder to install *EzDent-i* Server or Client for Windows.

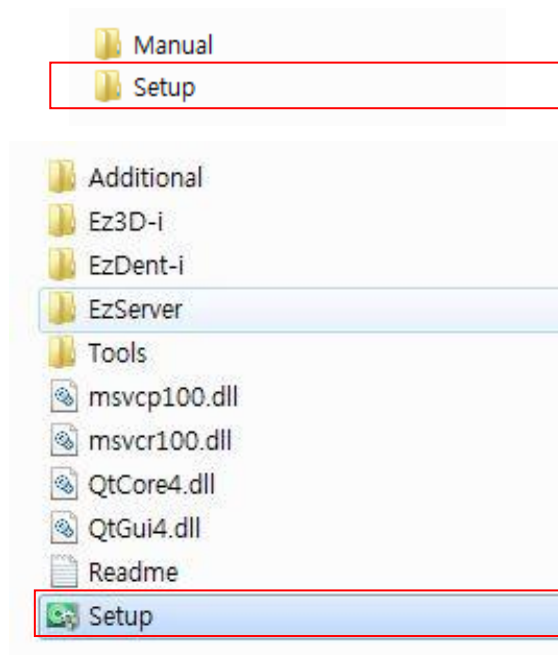

Step 2

The window for selecting installation mode will be shown. To set up the Server environment, start the installation by clicking the [Server] button.

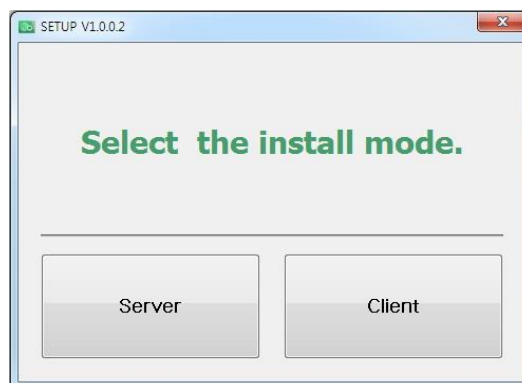

Step 3

The window for component setting will be displayed
After selecting programs to install among EzServer, ConsultData, and ImplantDB click the [EzServer] button.

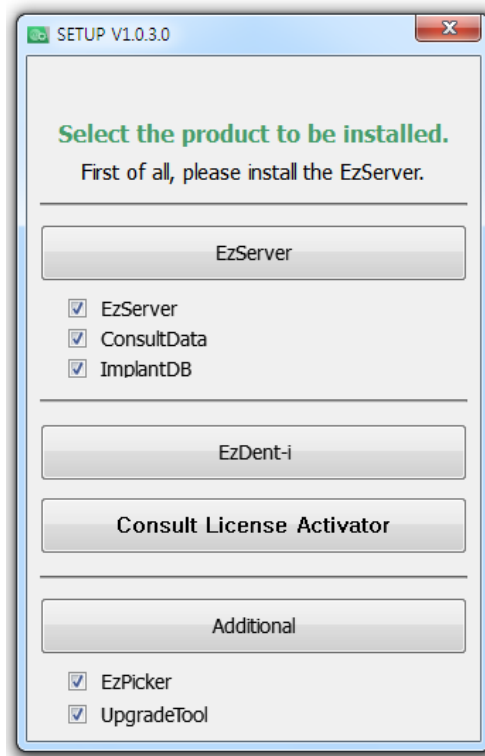

Step 4

To continue, click the [Next] button, followed by the [install] button to proceed.

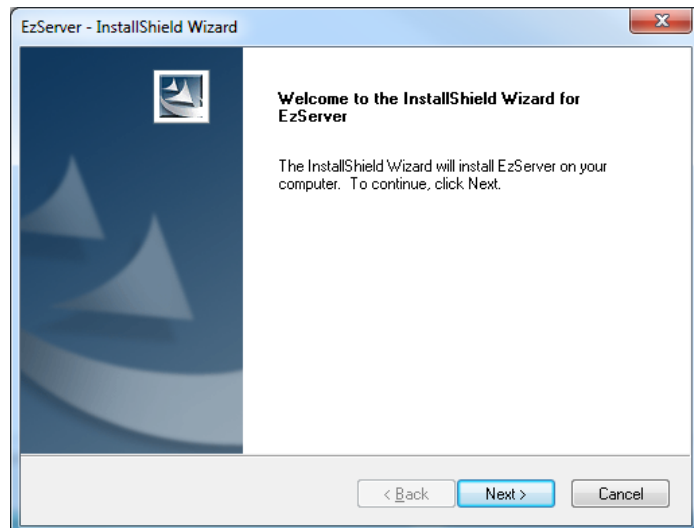

When the installation of EzServer is complete, the other components (ConsultData and ImplantDB) will automatically start installing.

If users did not select any other components, the installation is finished.

Step 5

Users can select the installation type of Implant DB, If users prefer to install multiple fixture models, select [complete], click the [Next] button to proceed.

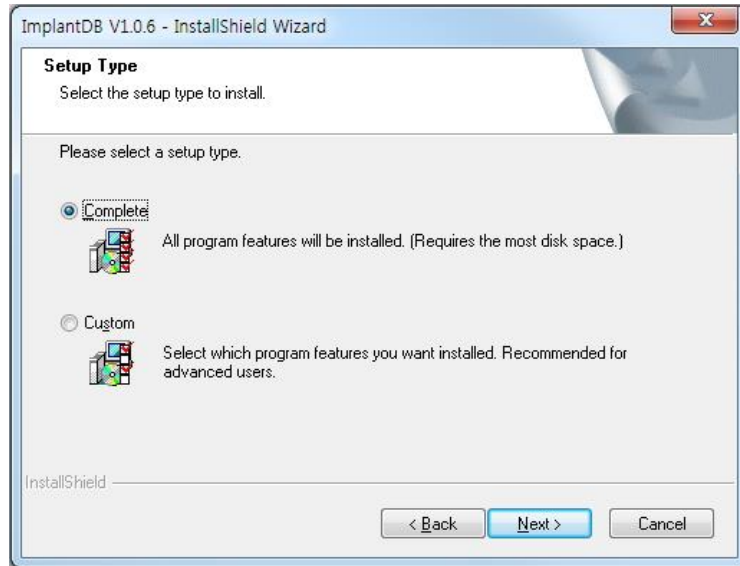

If users prefer to install the implant models separately, select [Custom] and click the [Next] button

Step 6

In case that [Custom] in implant DB is selected, Select the name of manufacturers you want to install and click the [Next] button to go forward.

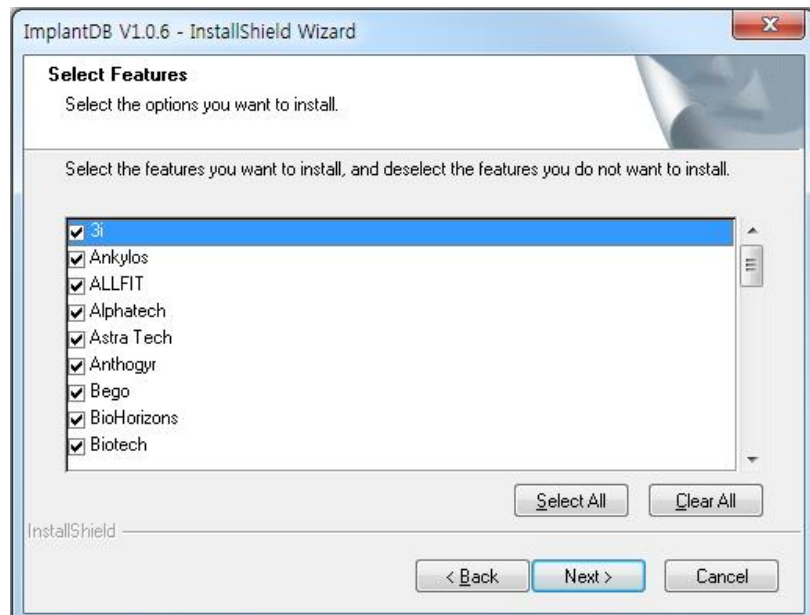

Step 7

Compile [setup.exe] and click the button, [EzDent-i],

'The License Agreement' window will be shown. If the conditions are acceptable, select

[I accept the terms of the license agreement] and click [Next] button

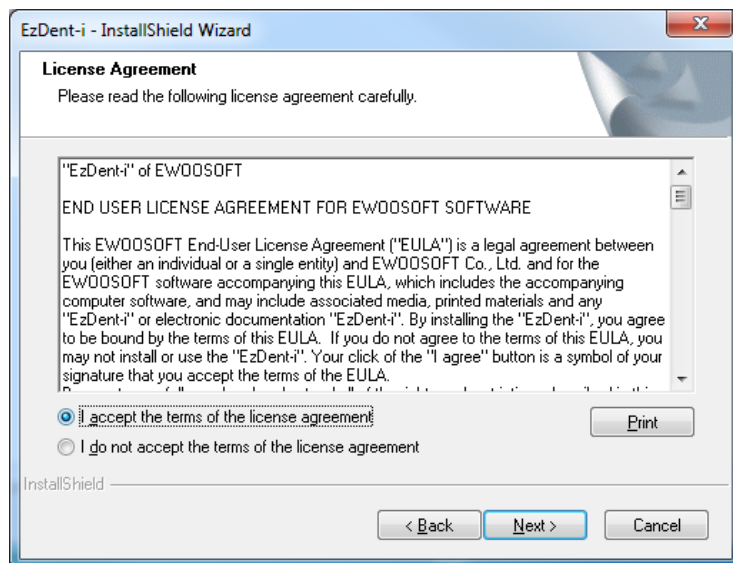
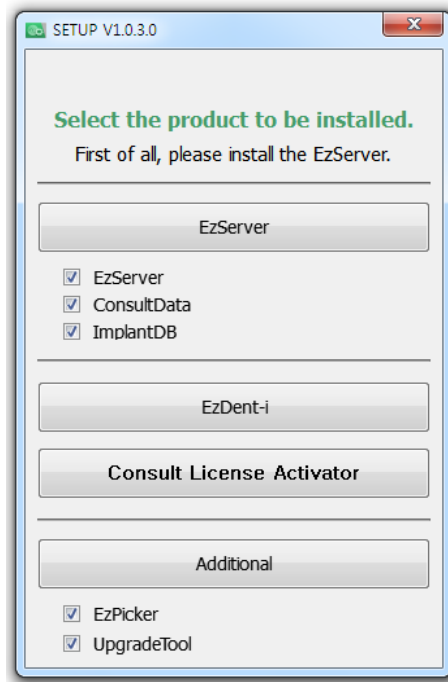

Step 8

Type in the company and username and click the [Next] button

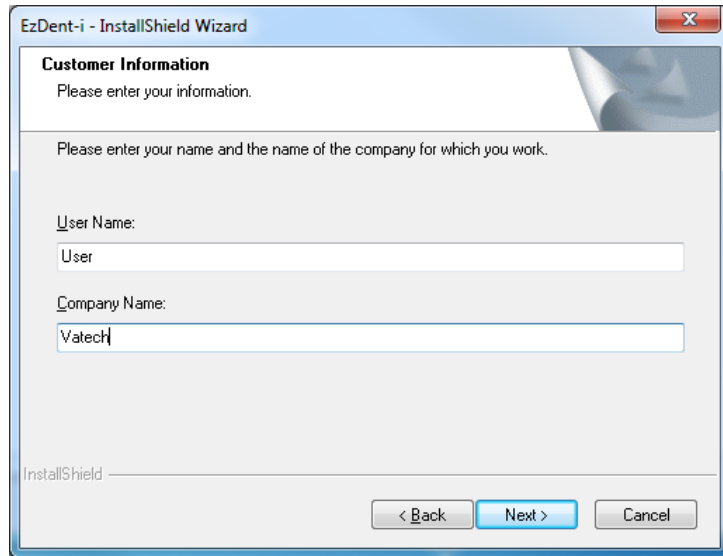

The screenshot shows the 'Customer Information' step of the EzDent-i installation wizard. The window title is 'EzDent-i - InstallShield Wizard'. The main heading is 'Customer Information' with the instruction 'Please enter your information.' Below this, a sub-instruction reads 'Please enter your name and the name of the company for which you work.' There are two text input fields: 'User Name:' containing 'User' and 'Company Name:' containing 'Vatech'. At the bottom right, there are three buttons: '< Back', 'Next >', and 'Cancel'. The 'Next >' button is highlighted in blue. The 'InstallShield' logo is visible in the bottom left corner.

Step 9

After specifying the location to install the program, click the [Next] button to go forward.

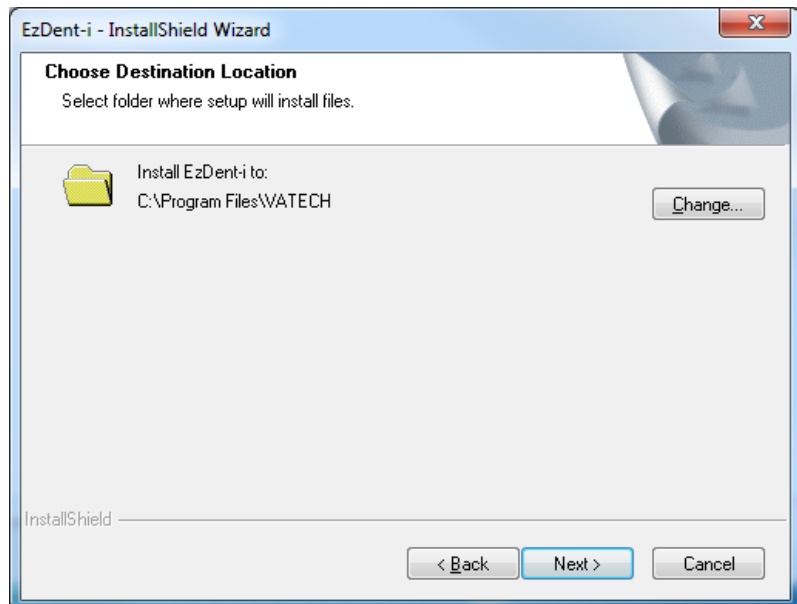

The screenshot shows the 'Choose Destination Location' step of the EzDent-i installation wizard. The window title is 'EzDent-i - InstallShield Wizard'. The main heading is 'Choose Destination Location' with the instruction 'Select folder where setup will install files.' Below this, there is a folder icon and the text 'Install EzDent-i to: C:\Program Files\WATECH'. A 'Change...' button is located to the right of the folder path. At the bottom right, there are three buttons: '< Back', 'Next >', and 'Cancel'. The 'Next >' button is highlighted in blue. The 'InstallShield' logo is visible in the bottom left corner.

Step 10

After installation of EzDent-i Console is complete, select [Yes, I want to restart my computer now] and click the [Finish] button. Then, the PC will be restarted.

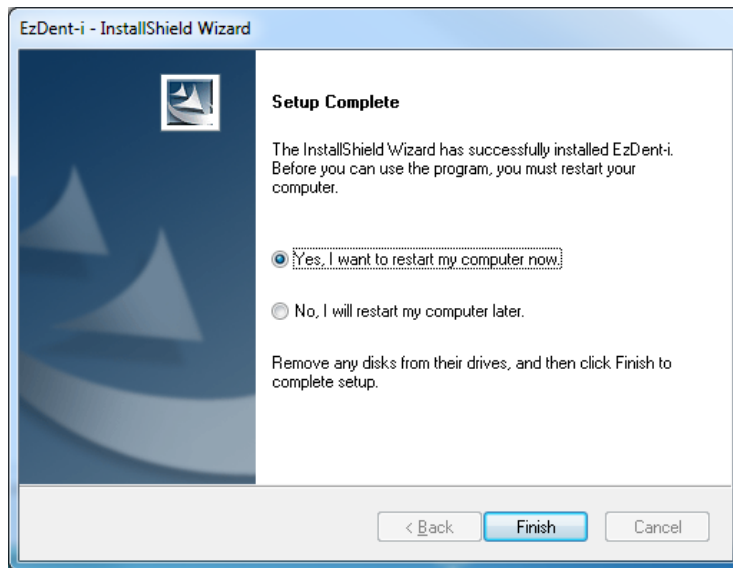

It is strongly recommended to restart the PC to apply the changes occurring in the system during the EzDent-i installation.

5.2 License Activation.

Step 1

Connect the USB Dongle Key to the PC, and open VTNL.exe.

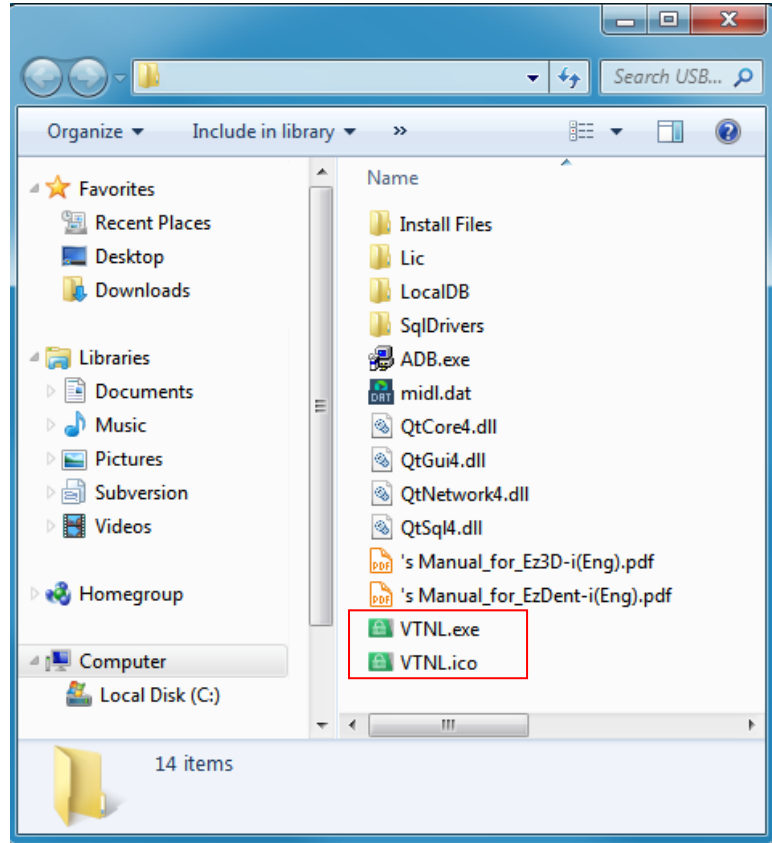

Opening VTNL

To open VTNL program, install ADB.exe file first. If the executable file is not installed, the installation process of ADB program will automatically start when opening VTNL program.

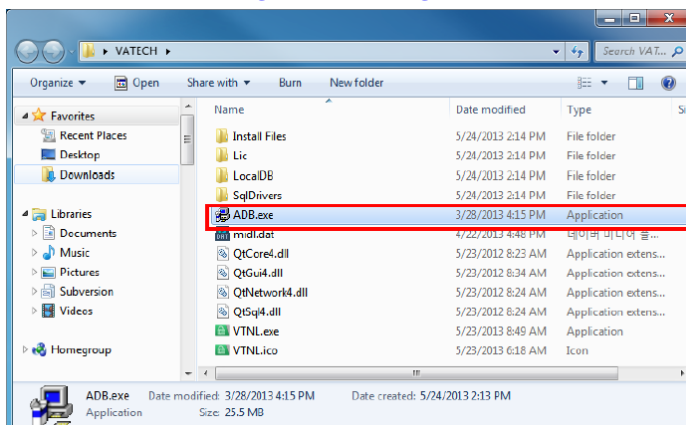

Step 2

The following License Activation Wizard appears if you have not activated a license previously

Select the dongle key (first) item, and then click the [Next] button.

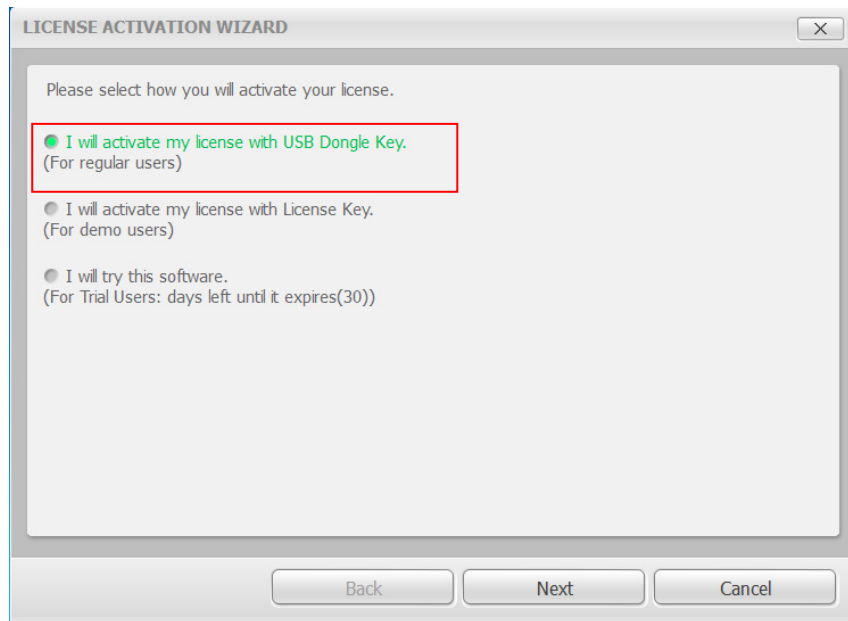

Step 3

When the following VTLicense Plugin Option appears, select the license key from the list and install by clicking the [OK] button.

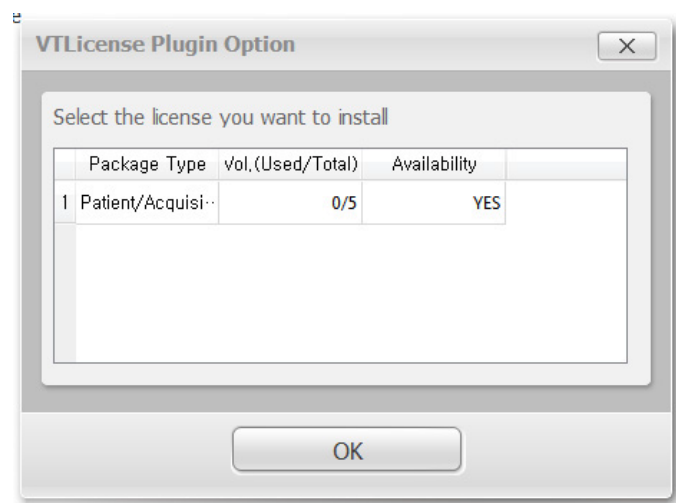

Step 4

After clicking the [OK] button, the following VTLicense Activation Wizard window appears. Once the license has been activated, click on the [Finish] button to complete your activation. EzDent-I will then run automatically.

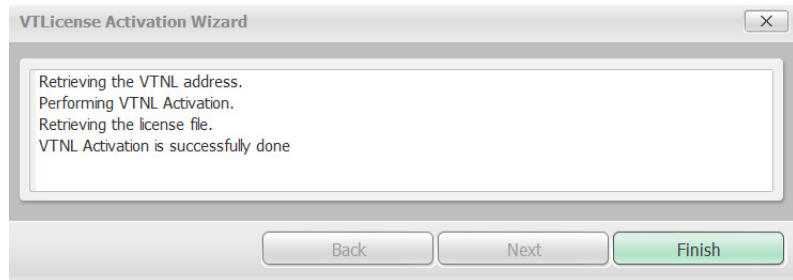

Once the license has been activated, the user's PC will appear on the list of [Certifications] in the VTNL window.

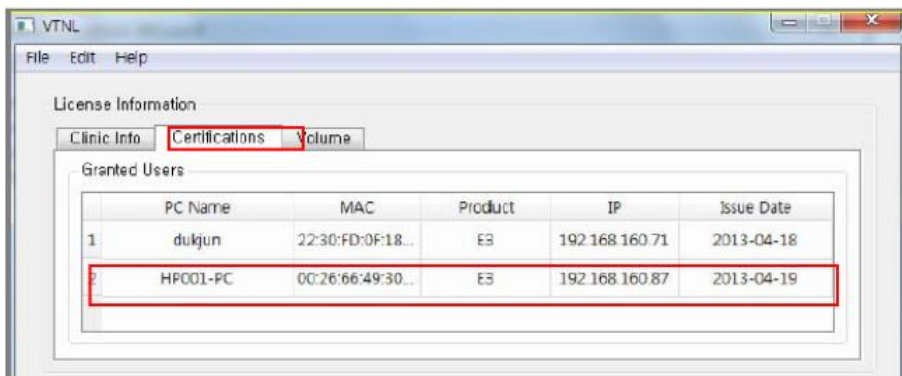

The dongle license key number appears on the list of [Volume] in the VTNL window.

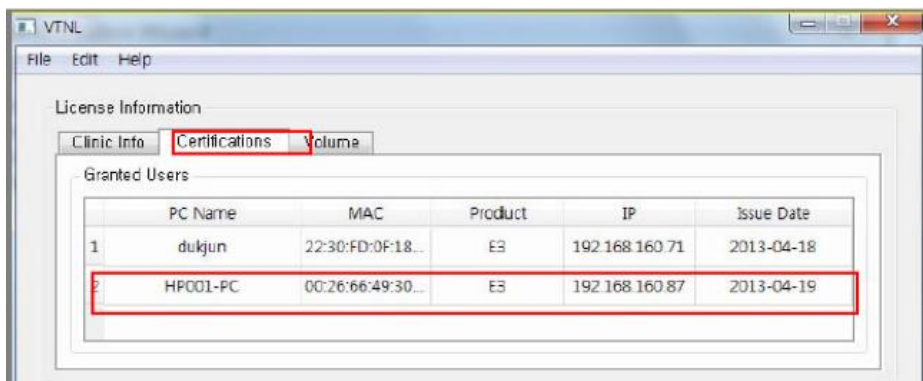

5.3 Consult DB License Activation



Consult DB is for the users who have a Consult Premium License. After activating Consult DB License, the user can utilize video contents for consultation use.

Step 1

Open [Setup.exe] from [Setup] folder to install **EzDent-i** Server or Client for Windows

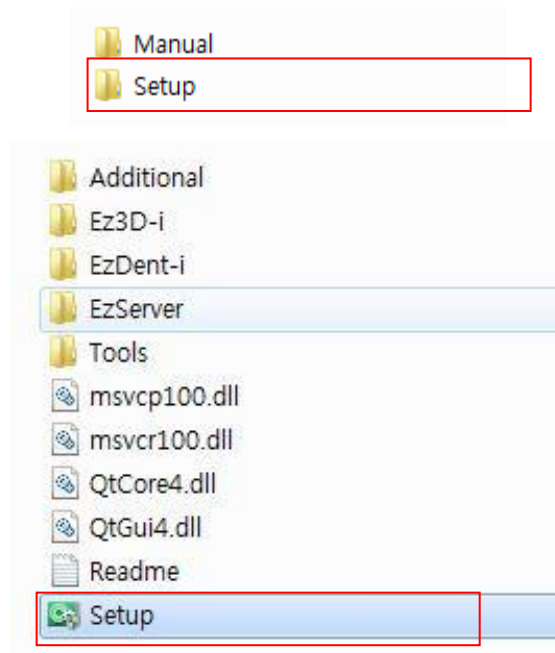

Step 2

After selecting the install modes, Click the [Consult License Activator] button

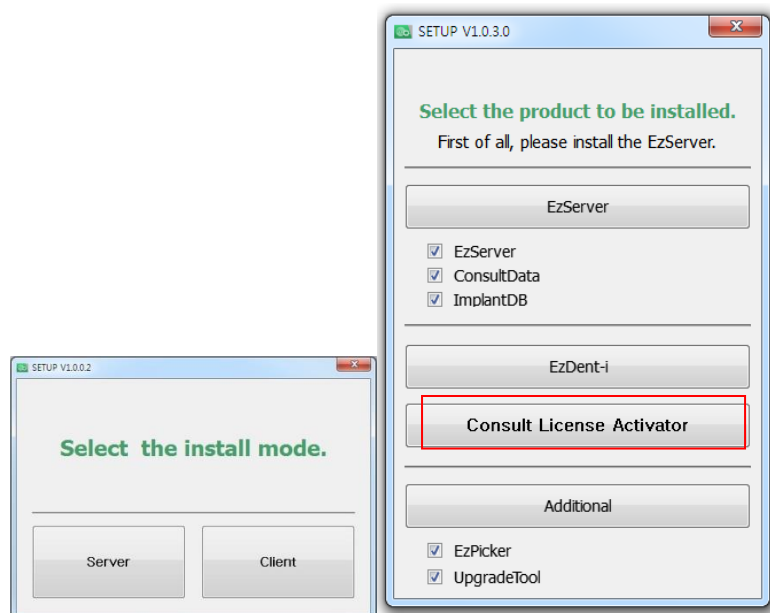

Step 3

After checking the license information shown at the Consult Data License Activator window, Click the [Activate] button.

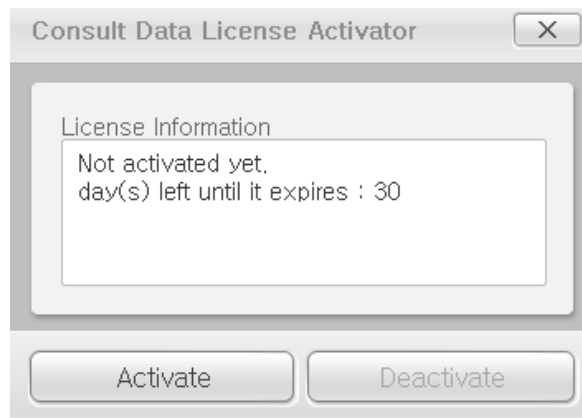

Step 4

Select the second option from the VT License Activation Wizard window.

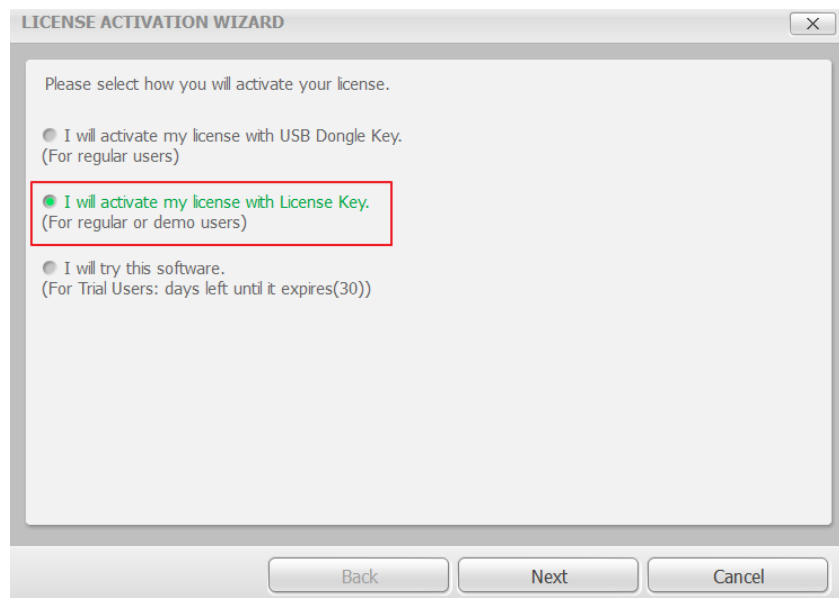

For activating license using the license key, an internet connection must be available with the PC.

Step 5

Enter the EzDent-i user information and license key provided. And then click the [Next] button. You must enter more than 3 characters to activate the [Next] button.

LICENSE ACTIVATION WIZARD

License Key: FEGY7pa FIEefwl LxgRsyf dfieowk CPkDSdj [Redacted] From clipboard

Clinic(Company): Vatech Clinic

Name: Dr.Vatech

E-mail: gcs@vatech.co.kr

Country: Republic of Korea

Collecting Information on Users and Use Agreement

EzDent-i may collect information about users. For installation and use of EzDent-i, you agree with the Collecting Information on Users and Use Agreement. Otherwise, it is limited to install and make a use of EzDent-i. User's information collected will not be used for a purpose other than that is set out in the following collecting purpose.

1. Collecting purpose of user's information, item collected and storage place

I accept the terms in the license agreement.

Buttons: Back, Next, Cancel

Step 6

Upon successful activation, the VT License Activation Wizard window will appear, including the remaining days. Click the [Finish] button to end the activation.

VTLicense Activation Wizard

Validating License Key

Opening License File.

Processing Activation.

This is an evaluation license, Your evaluation period will expire in 30 days.

Buttons: Back, Next, Finish

5.4 Preparing for Image Acquisition

- ① Turn on the computer.
- ② Run the **EzDent-i**.
- ③ Configure the required X-ray parameters (exposure time, etc.) for the X-ray generator.
- ④ For the operation test before X-ray exposure to patients, X-ray exposure as putting the coin on the flat receptor of the sensor is recommended.
- ⑤ Position the **EzSensor Soft** at the appropriate area in the mouth. The flat receptor side of the sensor must face the X-ray source. Note that the receptor side is marked with a label for ease of recognition
The use of the sensor positioning aid is recommended to guarantee that the sensor is parallel to the tooth and is at the appropriate angle for exposure
- ⑥ The use of the parallel technique with a positioning system or device, if possible, is highly recommended.
- ⑦ After preparing the sensor for exposure, acquire an image by pressing the exposure button of your X-ray source.



Using the EzSensor soft
With intraoral X-ray



Using the EzSensor soft
With a Sensor positioning system(optional)

5.5 Running the EzDent-i

5.5.1 Patient Registration

Step 1

Turn on the PC. Run **EzDent-i**. Click the 'Patient ()' button to register a new patient.

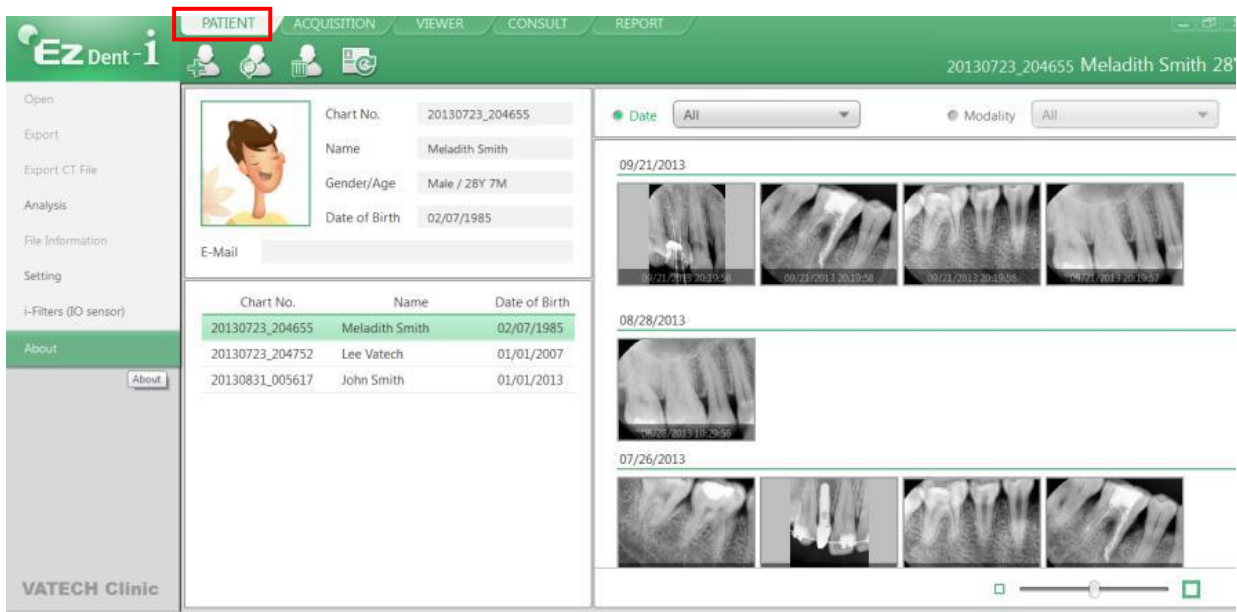

Step 2

The “Add Patient” registration window will appear. Register the new patient and click “Add.”

ADD PATIENT ✕

PHOTO

Chart No.*

Name*

Gender

Date of B... Year: Month: Day:

Email

5.5.2 Acquiring Image

Step 1

The Acquisition Tab allows the user to capture/store images with the IO Sensor.

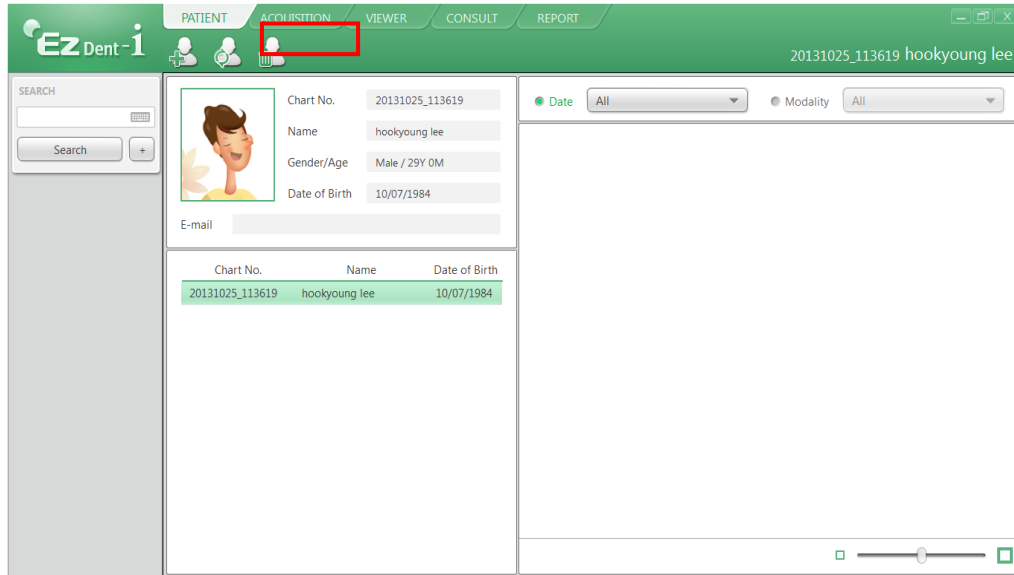

By clicking the logo, “EzDent-i” as below, you can select resolution mode between Normal and High.

If resolution mode is changed, restarting program is required.

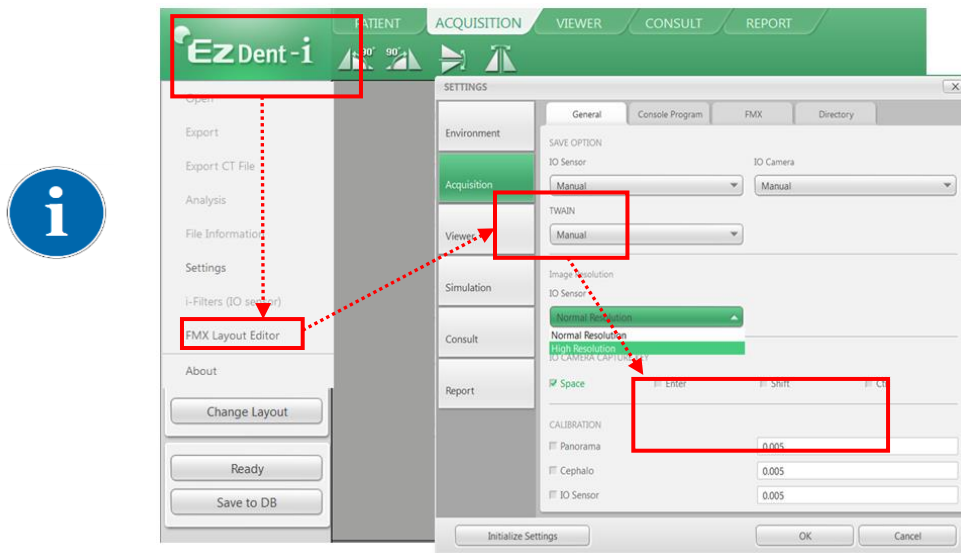

Normal Resolution Mode

This mode is typical operating and general usage and somewhat shows lower resolution, but gets the speed of data readout faster.

Step 2

Click the [IO Sensor] button in the Acquisition tab. Once the IO sensor is connected, the layout will change depending on the selected device.

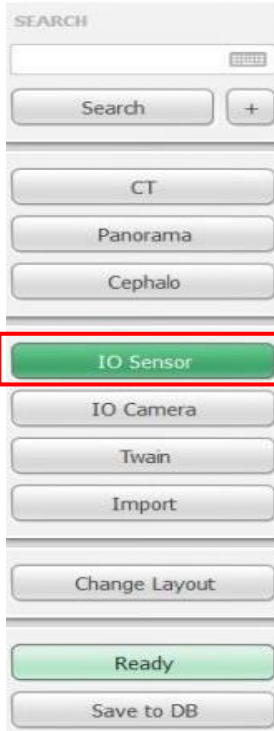

Step 3

Click the [Ready] button after positioning the patient. If the IO Sensor equipment is properly connected, the image acquisition mode will be initiated.

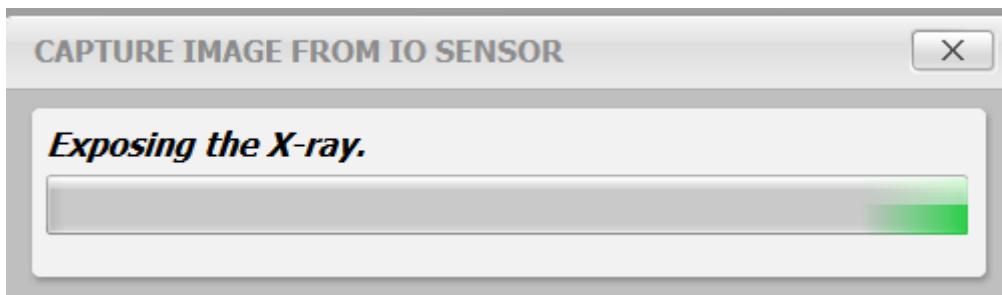
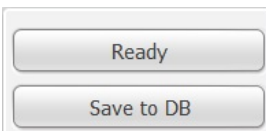

By double clicking the workspace from the ACQUISITION tab, EzDent-i will be ready for image acquisition. The [Ready] button provides the same function.



Step 4

Using the exposure switch, shoot the x-ray and the image will be acquired.
The process of acquiring the image is complete.

Step 5

Select the images from the thumbnails, and then click the [Save to DB] button. The captured images will be stored in the DB.



If the user wants to select more than 2 images, hold the Ctrl key on the keyboard and click the desired images from the thumbnails.



To change the way of storing the acquired images, change the options in settings. All the acquired images are automatically stored in DB if the “Auto DB Save” option is used and only the selected images are stored in DB with the “Manual” option is used.

Step 6

Select the images from the thumbnails, and then click the [Save to DB] button. The captured images will be stored in the DB.

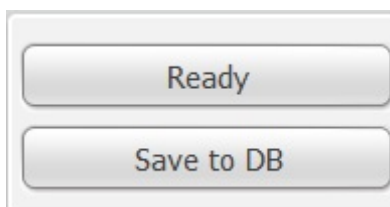

If the user wants to select more than 2 images, hold the Ctrl key on the keyboard and click the desired images from the thumbnails.



To change the way of storing the acquired images, change the options in settings. With the option "Auto DB Save," all acquired images are automatically stored in DB. Another option, Manual, only stores selected images in DB.

5.5.3 Image View

Step 1

Enter the name or chart number of the patient in the Patient Search window and click the [Search] button or press the Enter key. The search result will appear.

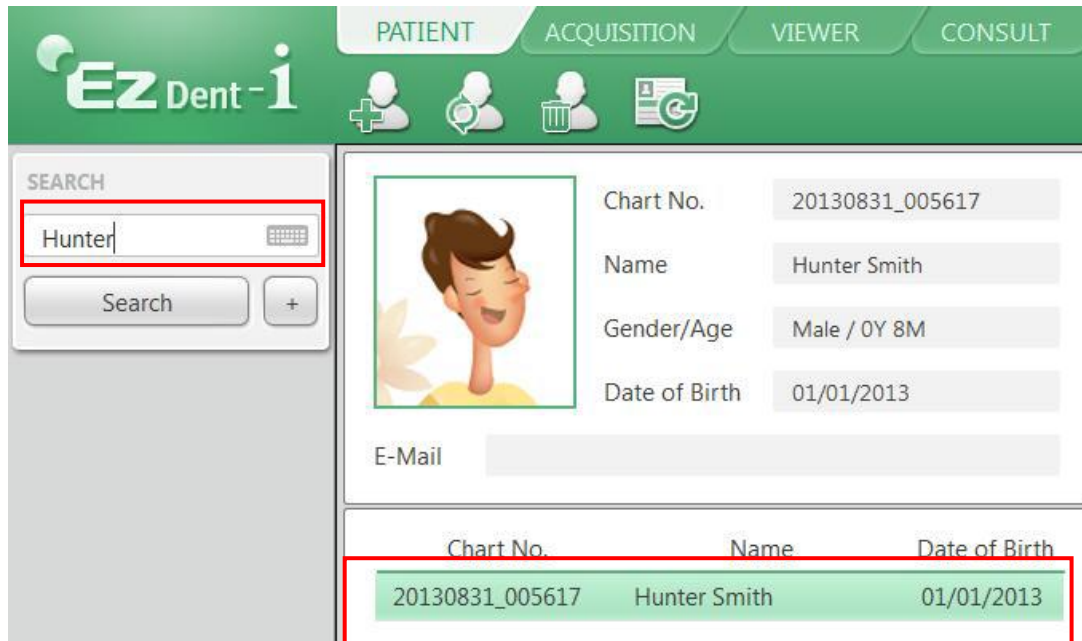

Step 2

Double Click the selected "Patient List".
The images will be displayed in the VIEWER tab.



Chapter 6 Maintenance

For optimal performance, MANUFACTURER recommends the working area be kept clean. There are no specific cleaning requirements for the **EzSensor Soft** beyond normal care and attention for aesthetic appearances.

6.1 Visual Inspection

Like all electrical systems or device, **EzSensor Soft** requires not only correct usage but also visual inspection prior to operation, as well as routine checks at regular intervals. These precautions will help ensure that the Product operates accurately, safely, and efficiently.

Before use, the operator should check the Product for any signs of physical damage or defects. If something out of order is suspected, contact your local Product distributor for further instructions on how to proceed.

6.2 Periodic Maintenance

Periodic maintenance should be performed as necessary and in accordance with monitored frequency in the table below. Maintenance should consist of various checks performed by the operator or by a qualified service technician.

- Check that all cables connected to the **EzSensor Soft** are undamaged.
- Check for any external damage to the **EzSensor Soft** that may compromise its ability to be safely operated. If the **EzSensor Soft** is defective, the sensor should be returned to the manufacturer for repair.
- Arrange the sensor and the control box USB cable to prevent damage to the cable's rubber tube. They should not be stepped on nor bent and pressed under table legs.



A qualified service technician is a person authorized by Rayence Co., Ltd. or affiliated distributors.

6.2.1 Test List

Test Item	Frequency	Equipment
Connection	Daily	Sensor & PC
Cable	Monthly	Cable
Resolution	Annually	<i>Resolution Patterns, Gammex Rmi</i>

6.2.2 Connection

●Object

Check the normal operation of PC when the sensor is connected to the PC

●Procedure

1. Connect the EzSensor Soft USB Connector to the USB Port
2. Confirmation of Driver installation at the Device Manager

Method of Confirmation:

Windows 7: Control Panel → System and Security → System → Device Manager

Windows XP: Settings → Control Panel → System → Hardware → Device manager

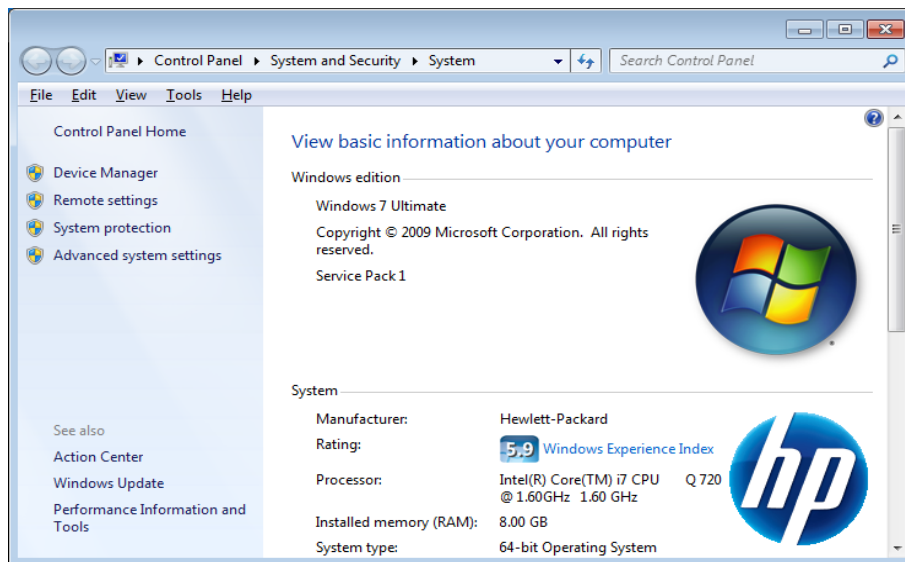

3. Select 'VH EzSensor-N x.x', located under Imaging Devices. You should see the message, "This device is working properly".

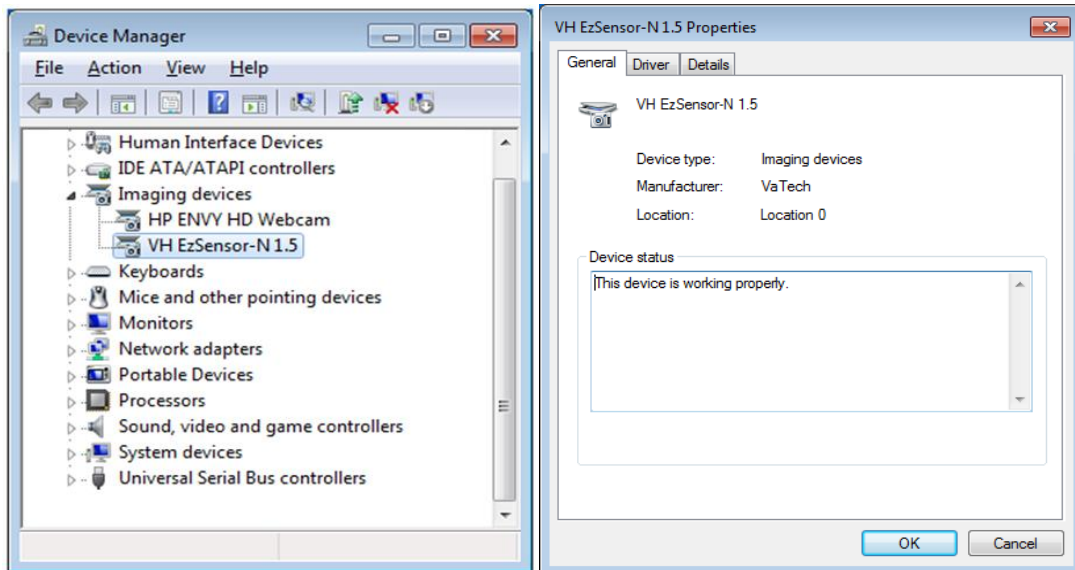

6.2.3 Cable

- Object

Prevent the sensor malfunction caused by the occurrence of external cable stress.

- Procedure

1. Arrange the sensor and the control box USB cable to prevent damage to the cable's rubber tube. They should not be stepped on nor bent and pressed under table legs.
2. Check that all cables connected to the EzSensor Soft are undamaged.

6.2.4 Resolution

- Object

Verify the resolution of EzSensor Soft

- Procedure

1. Run EasyDent(EzDent-i) with connecting EzSensor Soft.
2. Attach resolution phantom in the center of the detector with diagonal direction.
3. Set X-ray Condition to 60~70kVp 50mAs and SID to 28cm
4. Confirm that the resolution is over 8lp/mm.

6.3 Care and Cleaning

In order to prevent infection, wipe the front plate of the sensor unit with ethanol or glutaraldehyde solution to disinfect it each time a different patient uses the instrument. If you plan to use a disinfectant other than those specified above, or you are mixing another disinfectant with ethanol, please consult a specialist because it may damage the plate.

To clean the **EzSensor Soft**, the following solutions are listed below. Please observe the precautions noted.

- Mild soap and water
- Isopropyl alcohol (70%)
- Most alcohol and ammonia-based cleaners
- Mild, non-abrasive cleaners

Please dip the sensor in either of the cleaning solutions listed above less than 60 seconds. After immersing the sensor in disinfectant, use a dry cloth to wipe the sensor. Use of another disinfectant may cause discoloration, but will not cause dysfunction of the sensor. Gently wipe the surface end-to-end in straight lines, without applying any pressure. After cleaning the surface of the **EzSensor Soft**, use a clean lint-free cloth to dry the Product, as required, until the surface is clean.

※ Clean the silicone cover using the same method.

※ Do not use the following cleaning materials.

- Hard brushes or scrapers of any kind
- Strong acids or alkaloids

6.4 Precautions

- Do not soak the Product through the USB cable or the sensor cable connectors.
- Authorized service personnel can repair calibration issues.
- Service personnel cannot handle problems that are not mentioned in this manual.

Please request repairs to the manufacturer through a VATECH dealer.

- Equipment and accessories are to be disposed safely at the end of the Product life cycle. National regulation must be observed.

6.5 Product complaint

Any healthcare professional (e.g., a customer or user of Product or system) who has any complaints should notify his or her distributor first, who will handle such issues.

If the Product may have caused or contributed to a serious injury to a patient, your distributor should immediately notify the manufacturer by telephone, fax, or written correspondence. The manufacturer will report it to the government according to their reporting process.



Do not modify this equipment without the authorization of the manufacturer.

Chapter 7 Warranty

MANUFACTURER hereby warrants **EzSensor Soft** ("Product") against defects in material and workmanship under normal usage and service for a period of agreement from the date of installation.

If the Buyer promptly notifies MANUFACTURER or the Seller regarding any parts that fail to perform as specified under normal usage during the Warranty Period and MANUFACTURER determines that such failure resulted from a defect in materials or workmanship during the Warranty Period, then MANUFACTURER, at its option, shall repair, rebuild or adjust the affected parts.

MANUFACTURER shall have no obligation for any defects that arise from (i) normal and fair wear and tear; the Product being modified without MANUFACTURER 's approval, (ii) not being installed in strict conformity to MANUFACTURER 's directions or having been subjected to electrical damage or other abuse, or damaged by improper handling, storage, or used by a third party, (iii) use of the Product in combination with devices or products not purchased from MANUFACTURER; (iv) use or application of the Product in a field or in an environment for which such the Product was not designed or contemplated; (v) use of any parts or material not provided by MANUFACTURER for warranty service (vi) the third party's maintenance not certified by MANUFACTURER; or (vii) force majeure such as natural disaster.

Repaired, rebuilt or adjusted component parts are warranted for 90 days or the remainder of the Warranty Period, whichever is longer. This Warranty extends solely to the Buyer and shall not extend to any person that purchases the Products from the Buyer or any other person, whether an entity or a natural person, in the chain of the use or distribution of the Products.

The warranty period for the Product shall including replacement of Non-Consumable parts and labor to correct warranty issues.

The Buyer will make all reasonable efforts to advise MANUFACTURER of the use of any non-MANUFACTURER authorized items, components, or parts of Product. If, after troubleshooting, it is determined that repairs (including replacement of any Items, components, or parts) to the Product under warranty are a result of a non-MANUFACTURER authorized item, component, or part, MANUFACTURER charge for all costs associated with the repair service rendered.

This expresses all of the MANUFACTURER's responsibilities regarding the Product, including the sale of the Product, the events giving rise to the sale of the Product, defects in the Product, and the failure of the Product to meet or perform in accordance with specifications or as intended. The remedies contained in this warranty are the Buyer's exclusive remedies. MANUFACTURER shall not, in any event, or under any circumstances, be responsible for damages or other sums in excess of the total purchase price actually paid by the Buyer to Seller i.e., MANUFACTURER or MANUFACTURER's dealer. Without limiting the generality of the foregoing, under no circumstance shall MANUFACTURER be responsible or liable in any regard with respect to damages from loss of use, loss of time, loss of data, inconvenience, commercial loss, lost profits or savings, or other incidental, special or consequential damages that arise out of the use or inability to use the Product, even if the Buyer has been advised of the possibility of such damages.

If the Buyer fails to pay any amounts due to the Seller, whether related to the Products or otherwise specified, MANUFACTURER shall have the right to refuse to provide any services to the Buyer under this Warranty until such payment has been received by the Seller.

In the event that the product is returned to MANUFACTURER after the warranty has expired, MANUFACTURER reserves the right to invoice a reasonable fee for the repair services provided to Buyer.

MANUFACTURER shall make the sole final determination about whether the failure to perform occurred in normal usage (under warranty) or not (excluded from warranty). If the dealer or the Buyer doesn't accept the result of MANUFACTURER's investigation, the burden of proof is on them.

Warranty Procedure

If the Buyer needs to make a claim based on this Warranty, the Buyer should immediately advise MANUFACTURER or the Seller in writing at the following address:

RAYENCE Co., Ltd.

14, Samsung 1-ro 1-gil, Hwaseong-si, Gyeonggi-do, Korea

Appendix

A.1 LED Indicators

The **EzSensor Soft** Hardware Controller has two LED indicators that show its functional status. The location of the LED lights is as shown in the following illustration and described in Table 3.

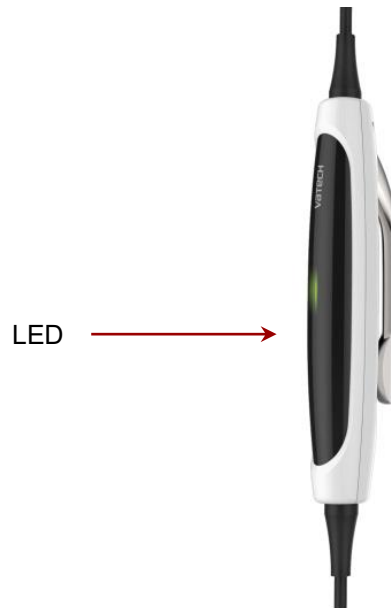

<Table 3. Description of LED Indicators>

Operational State	LED State LED	Functional Status Confirmation
Initial State	BLUE	USB Connection
Standby	GREEN	Capture standby
Trigger (X-ray On)	YELLOW	X-ray On and Sensor Trigger On
Data Transmission with the USB PC interface cable	YELLOW	Confirm data transmission with the sensor board

A.2 X-ray Exposure Guide

The required X-ray dose for the best image is dependent on the following:

- X-ray source (tube assembly, manufacturer, AC/DC, etc.)
- Distance between beam focus and sensor
- Tooth (object) to be X-rayed
- Bone density and age of patient
- Miscellaneous circumstances, etc.

The X-ray dose influences image quality. Based on fundamental laws of physics, an insufficient dose generally means higher image noise, which leads to poor detail discrimination. On the other hand, an excessively high dose can cause the sensor to be overexposed. This is also perceptible by a decrease in detail discrimination, specifically in darker areas.

The effect of image processing reduces the difference between image qualities of different doses. Users can adjust brightness and contrast in the option menu.

The recommended exposure dose is from 300 μ Gy to 600 μ Gy when measuring without an object. Exposure time corresponding to the dose may vary depending on the X-ray equipment used. Recommended exposure times according to positions are as shown on the Exposure Time Table.

The X-ray dose is maintained through tube voltage (kVp) and current (mA), as well as exposure time according to the signal level.



Since the exposure time depends on the diagnostic problem as well as the clinical situation, the selection of an adjustment is the responsibility of the treating physician.



Image degradations caused by overexposure of the sensor cannot be compensated, but an insufficient dose can be partially compensated through image processing.

<Table 4.Recommendation on Exposure Time >

Exposure condition	Dose (μGy)	60kvp 6mA	60kVp 2mA	60kVp 7mA
Patient		Adult	Adult	Adult
SID		28cm	18cm	20cm
Intra Oral X-ray Unit (Model name)	No Filter	VX 70	AnyRay	EzRayP
		Approximate Exposure Time (sec)		
Incisor & Canine	300 ~ 500	0.12 ~ 0.2	0.1 ~ 0.2	0.07 ~ 0.10
Molar	400 ~ 600	0.16 ~ 0.25	0.15 ~ 0.25	0.13 ~ 0.14

* SID: Source to imaging receptor Distance

*Recommendation on Exposure Time is limited to Intra Oral X-ray Unit in the above table

For larger body types: increase the source current by 25%



For children(5~21age): reduce the source current (or Exposure time) by 20%

For edentulous patients: reduce the source current by 20%.

Since the X-ray exposure condition can be changed depending on the age, gender and bone density of the patient, in case of Pediatric, X-ray exposure condition can be changed by expert's judge.



For further information, please refer to FDA Pediatric X-ray Imaging webpage,

<http://www.fda.gov/radiation-emittingproducts/radiationemittingproductsandprocedures/medicalimaging/ucm298899.htm>

)



The X-ray dose required for image acquisition can vary depending on the X-ray source and environmental circumstances. You must maintain the exposure time and change the kVp and mA values according to the signal level. In addition, if the X-ray source and the distance to the sensor were changed during the initial installation, the distance (from cone to detector) must be changed to the 80mm setting.

The exposure time may vary depending on the age, gender, and bone density of the patient.

A.3 Error Message

1. USB device driver is not installed.
 - Solution: Please install the device driver again.

2. The control box cannot be initialized.
 - Solution: Check and re-connect the USB PC interface cable.

3. USB device driver is not working properly.
 - Solution: Re-install the driver.

4. Capture program is already running.
 - Solution: Please close any other programs.

5. Detector response time-out.
 - Check and re-connect the USB PC interface cable. Please try again.
If the same message is displayed again, contact Customer Service.

6. Data communication error.
 - Solution: Re-connect the USB PC interface cable.

7. Canceled image capturing.
 - This means that the user canceled image capture. Please try again.

8. Cannot find a dark frame.
 - Solution: Restore the EzSensor Soft's calibration data from the S/W installation CD or re-calibrate the sensor. If the same message is displayed again, contact Customer Service.

9. Cannot find bright frames for calibration.
 - Solution: Reinstall the EzSensor Soft driver.

10. Bad Pixel Map correction error.
 - Solution: Restore the EzSensor Soft's calibration data from the S/W installation CD or re-calibrate the sensor. If the same message is displayed again, contact Customer Service.

11. Wrong image processing parameters.

- Solution: Check the X-ray source. If the problem persists, call for technical assistance.

12. Cannot load 'EzSensor.dll'.

- Solution: Please re-install the acquisition software.

13. Require 'EzSensor.dll' was damaged.

- Solution: Please re-install the acquisition software.

A.4 Troubleshooting

If you experience any problems regarding the **EzSensor Soft** during operation, please refer to the troubleshooting table below for corrective measures. If the problem persists, please contact your local Product Distributor.

<Table 5.Troubleshooting Table>

Item	Description	Corrective Measure
1	LED 1 on the control board box does not illuminate after installing the Product.	Check that the USB PC interface cable is plugged in correctly at the control board box and on the console PC.
2	A 'PID 2XXX NO; interface #0 (Check Connection)' error message is displayed.	Unplug the USB PC interface cable from the control board box and then reconnect it. Open the Windows Device Manager and check that the device is installed correctly. Alternatively, try another USB port on your computer.

A.5 Electromagnetic Compatibility Information

Guidance and manufacturer's declaration – electromagnetic emissions		
The Product is intended for use in an electromagnetic environment as specified below. The customer or the user of the Product should ensure that it is used in such an environment.		
Emissions test	Compliance	Electromagnetic environment - guidance
RF emissions CISPR 11	Group 1	The Product uses RF energy only for its internal functions. Therefore, its RF emissions are very low and are not likely to cause any interference to nearby electronic equipment.
RF emissions CISPR 11	Class A	The Product is suitable for use in all establishments, including domestic establishments, and those directly connected to a personal computer USB port used for domestic purposes.
Harmonics emission IEC 61000-3-2	A	
Voltage fluctuation IEC 61000-3-3	Complies	

Guidance and manufacturer's declaration – electromagnetic emissions			
The Product is intended for use in an electromagnetic environment as specified below. The customer or the user of the Product should ensure that it is used in such an environment.			
Immunitytest	IEC 60601 test level	Compliance level	Electromagnetic environment – guidance
Electrostatic discharge (ESD) IEC 61000-4-2	± 6 kV contact ± 8 kV air	± 6 kV contact ± 8 kV air	Floors should be wood, concrete or ceramic tiles. If floors are covered with synthetic material, relative humidity should be at least 30%.
Electrical fast transient/burst IEC 61000-4-4	± 2 kV for power supply lines ± 1 kV for input/output lines	± 2 kV for power supply lines ± 1 kV for input/output lines	Mains power quality should be that of a typical commercial or hospital environment.
Surge IEC 61000-4-5	± 1 kV differential mode ± 2 kV common mode	± 1 kV differential mode ± 2 kV common mode	Mains power quality should be that of a typical commercial or hospital environment.
Voltage dips, short interruption, and voltage variations on power supply input lines IEC 60601-4-11	< 5 % U_T (> 95 % dip in U_T) for 0.5 cycles 40 % U_T (60 % dip in U_T) for 6 cycles 70 % U_T (30 % dip in U_T) for 30 cycles < 5 % U_T (> 95 % dip in U_T)	< 5 % U_T (> 95 % dip in U_T) for 0.5 cycles 40 % U_T (60 % dip in U_T) for 6 cycles 70 % U_T (30 % dip in U_T) for 30 cycles < 5 % U_T (> 95 % dip in U_T)	Mains power quality should be that of a typical commercial or hospital environment. If the user of the Product requires continued operation during power mains interruptions, it is recommended that the Product is powered by an uninterruptible power source or battery.

	for 5 s	for 5 s	
Power frequency (50/60 Hz) IEC 61000-4-8	3.0 A/m	3.0 A/m	Power frequency magnetic fields should be at levels characteristic of a typical location in a typical commercial or hospital environment.
Conducted RF IEC61000-4-6	3 Vrms 150 kHz to 80MHz	3 Vrms 150 kHz to 80MHz	Portable and mobile RF communications equipment should be used no closer to any part of the Product, including cables, than the recommended separation distance calculated from the equation applicable to the frequency of the transmitter. Recommended separation distance $d = \left[\frac{3,5}{V_1} \right] \sqrt{P}$
Radiated RF IEC61000-4-3	3 V/m 80 MHz to 2.5GHz	3 V/m 80 MHz to 2.5GHz	Recommended separation distance $d = \left[\frac{3,5}{E_1} \right] \sqrt{P} \text{ 80 MHz to 800 MHz}$ $d = \left[\frac{7}{E_1} \right] \sqrt{P} \text{ 800 MHz to 2,5 GHz}$ Where P is the maximum output power rating of the transmitter in watts (W) according to the transmitter manufacturer and d is the recommended separation distance in meters (m). Field strengths from fixed RF transmitters, as determined by an electromagnetic site survey, (a) Should be less than the compliance level in each frequency range (b). Interference may occur in the vicinity of equipment marked with the following symbol: 
<p>Note 1) U_T is the A.C. mains voltage prior to application of the test level. Note2) At 80 MHz and 800 MHz, the higher frequency range applies. Note3) These guidelines may not apply in all situations. Electromagnetic propagation is affected by absorption and reflection from structures, objects, and people.</p> <p>a Field strengths from fixed transmitters, such as base stations for radio (cellular/cordless) telephones and land mobile radios, amateur radio, AM and FM radio broadcast and TV broadcast cannot be predicted theoretically with accuracy. To assess the electromagnetic environment due to fixed RF transmitters, an electromagnetic site survey should be considered. If the measured field strength at the location in which the Products used exceeds the applicable RF compliance level above, the EUT should be observed to verify normal operation. If abnormal performance is observed, additional measures may be necessary, such as re-orienting or relocating the Product. b Over the frequency range 150 kHz to 80 MHz, field strengths should be less than $[V_1]$ V / m.</p>			

Recommended Separation Distances Between Portable and Mobile RF Communications Equipment and the Product.			
The Product is intended for use in an electromagnetic environment in which radiated RF disturbances are controlled. The user The Product can help prevent electromagnetic interference by maintaining a minimum distance between portable and mobile RF communications equipment (transmitters) and The Product as recommended below, according to the maximum output power of the communications equipment.			
Rated maximum output power (W) of the transmitter	Separation distance (m) according to frequency of transmitter		
	150 kHz to 80 MHz	80 MHz to 800 MHz	800 MHz to 2.5 GHz
0.01	0.12	0.12	0.23
0.1	0.37	0.37	0.74
1	1.17	1.17	2.33
10	3.70	3.70	7.37
100	11.70	11.70	23.30
For transmitters rated at a maximum output power not listed above, the recommended separation distance (d) in meters (m) can be estimated using the equation applicable to the frequency of the transmitter, where P is the maximum output power rating of the transmitter in watts (W) according to the transmitter manufacturer.			
Note 1: At 80 MHz and 800 MHz, the separation distance for the higher frequency range applies			
Note 2: These guidelines may not apply in all situations. Electromagnetic propagation is affected by absorption and reflection from structures, objects, and people.			

Copyright by © 2013 Rayence Co., Ltd.

The information in this document is subject to change without notice and does not represent a commitment on the part of the vendor.

This document contains materials protected under International Copyright Laws. All rights reserved. No part of this manual may be reproduced, transmitted, or transcribed without the expressed written permission of the manufacturer and authors of this manual.

If you do not properly set the Product, which in turn causes the Product to malfunction or fail, we cannot guarantee any responsibility.



Rayence Co., Ltd.

Web Site ▶ www.rayence.com

14, Samsung 1-ro 1-gil, Hwaseong-si, Gyeonggi-do, Korea



CE symbol grants the product compliance to the European Directive for Medical Devices 93/42/EEC as a class IIa device.

Authorized by SGS United Kingdom Ltd



VATECH Dental Manufacturing Ltd.

Chancery House, St. Nicholas Way, Sutton, SM1 1JB UK

Tel: +44 020 8652 1900, Fax: +44 020 8652 1909

VATECH America Inc.

2200 Fletcher Ave. Suite 705A, Fort Lee, NJ07024

Tel: +1 888 396 6872

EzSensor Soft™

Document No. R-USM-710
Release Version 1.4
Dated Feb. 23, 2018

ZIP Code: 18449
13, Samsung 1-ro 2-gil, Hwaseong-si, Gyeonggi-do, Korea
www.vatech.co.kr

vatech