

**vatech** america

[Version 1.1]

Pax-I3D Green CT 2 (16x09)

Fundamentals of 2D and 3D

July 2020

Education Team

**vatech**

# Index

## **1 – 2D Imaging:**

- I. Capture Software Navigation
- II. Pan, Bitewing and Edentulous Positioning Appliances and Laser Lights
- III. Panorama Proper vs Improper Positioning
- IV. Single Page - Patient Positioning and Instruction Guides
- V. TMJ Positioning Appliances and Laser Lights
- VI. Sinus Positioning Appliances and Laser Lights

## **2 – 3D Imaging:**

- I. Capture Software Navigation
- II. Positioning Appliances and Laser Lights
- III. Field of View (FOV) and Regions of Interest
- IV. Proper vs Improper Positioning
- V. Single Page - Patient Positioning and Instruction Guide

## **3– Addendum:**

- I. 3D TMJ/Airway Scan Protocol
  - 3D TMJ/Airway Capture Software Navigation
  - Single Page – 3D TMJ/Airway Patient Positioning and Instruction Guide
- II. 3D Scanning Stone Models
  - STL Model Scan Capture Software Navigation
- III. 2D Ceph Capture Software Navigation
  - 2D Ceph Positioning and Laser Lights
- IV. Customer Learning Center Link

# 01. 2D Imaging



# 01-I. Capture Software Navigation

## 2D Image Capture Software – *Pre-Capture Options:*

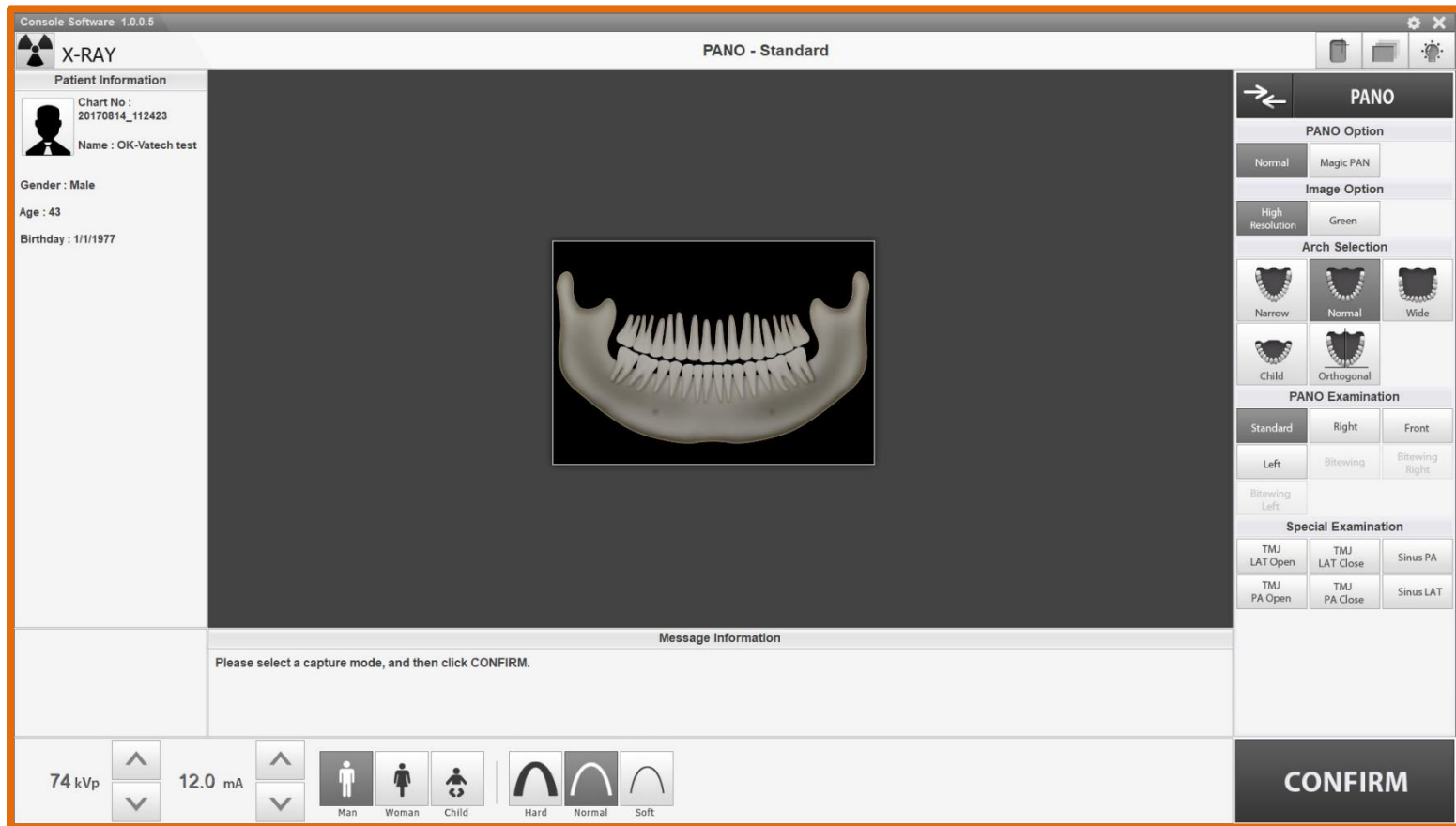

# 01-I. Capture Software Navigation

## 2D Image Capture Software – *Post Capture Options:*

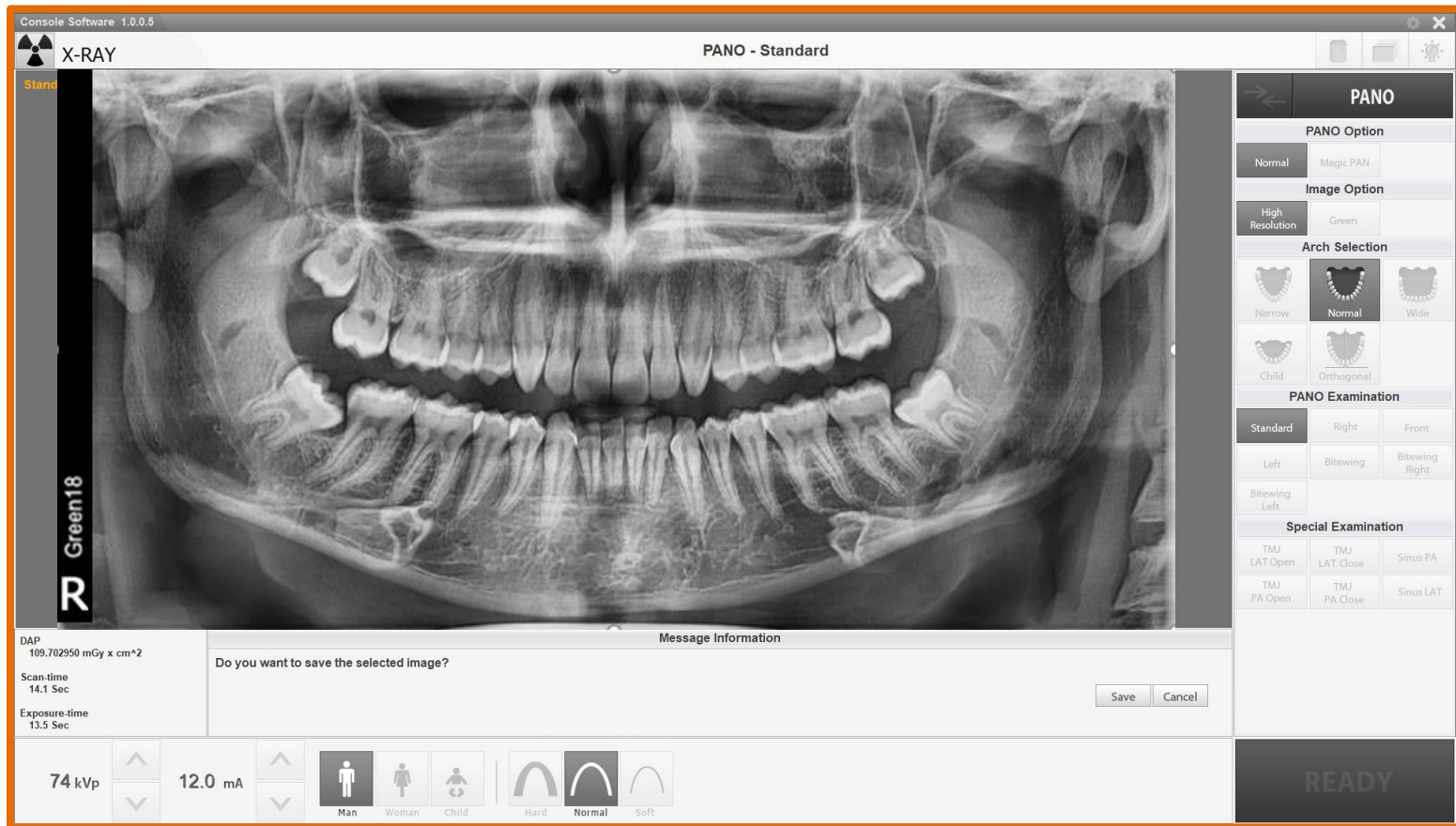

## 01-II. Positioning Appliances and Laser Lights

---

Components	Name and Function
	Bite Stick: - <i>Pan, Bitewing and CBCT</i>
	Chin Support: - <i>2D TMJ and Sinus CBCT TMJ</i>
	Chin Cup: - <i>Edentulous</i>
	Normal Chin Support
	Low Profile Chin Support: - <i>Sinus &amp; TMJ</i>

## 01-II. Positioning Appliances and Laser Lights

---

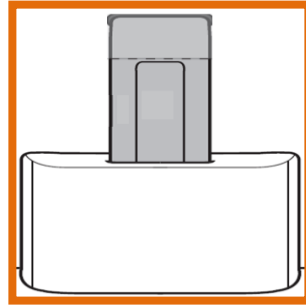

**Panorama:**  
*Bite Stick with  
Pan/CBCT Chinrest*



## 01-II. Positioning Appliances and Laser Lights

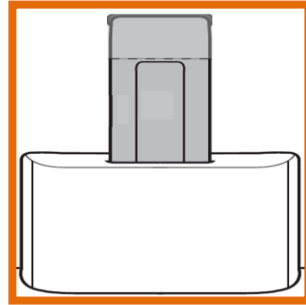

**Bitewing:**  
*Bite Stick with  
Pan/CBCT Chinrest*

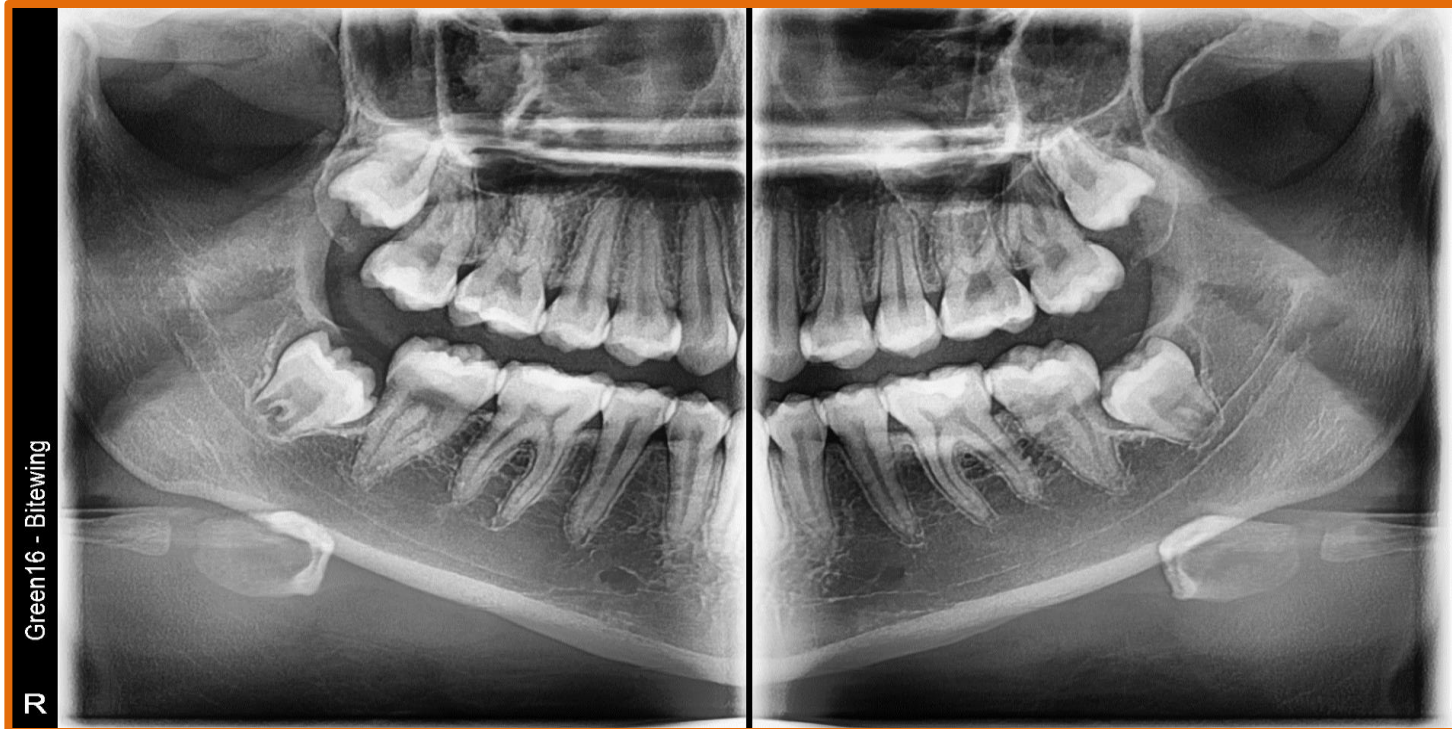



## 01-II. Positioning Appliances and Laser Lights

---



**Edentulous:**  
*Sinus/Edentulous Appliance with  
Pan/CBCT Chinrest (not shown)*



## 01-II. Positioning Appliances and Laser Lights

# Touch Pad

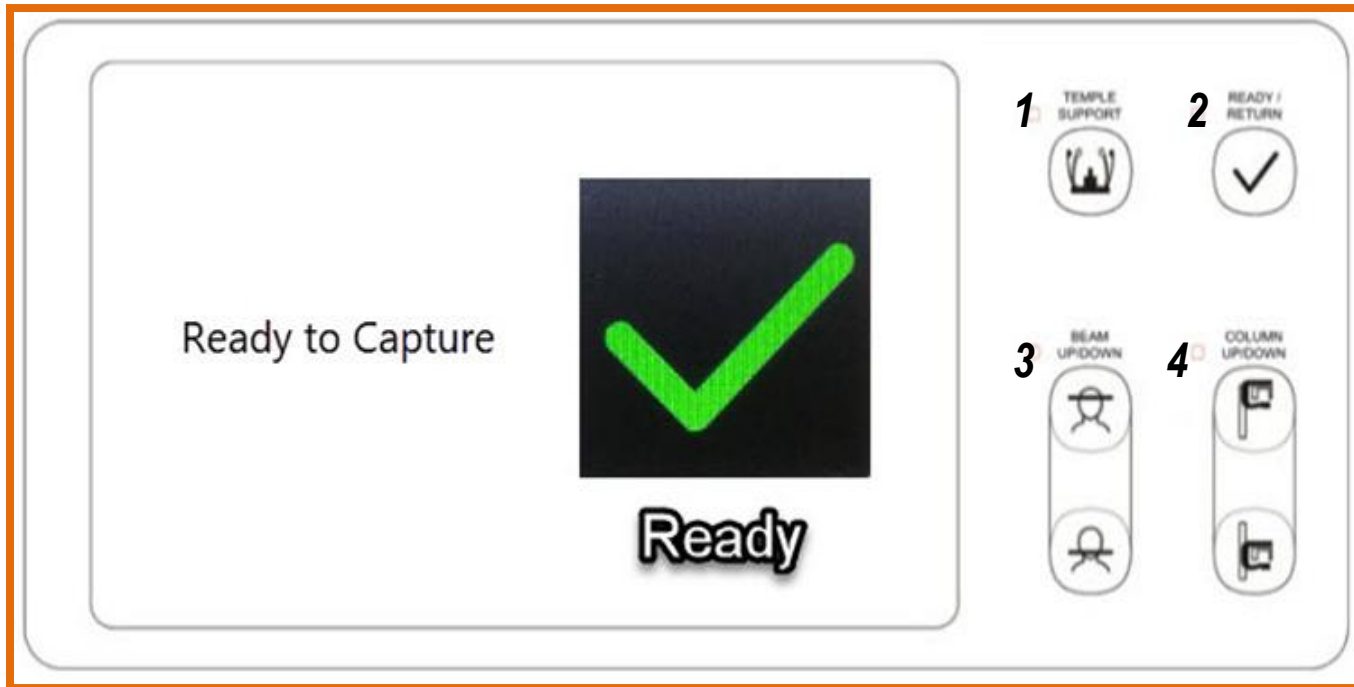

- 1- Open and Close Temple Rods***
- 2- Move System into "Ready" (Capture) mode***
- 3- Adjust Frankfurt Light***
- 4- Adjust for Patient Height***

## 01-II. Positioning Appliances and Laser Lights

---

**PANORAMA OBJECTIVE : “Natural Head” Position (Panorama and Bitewing Modes)**

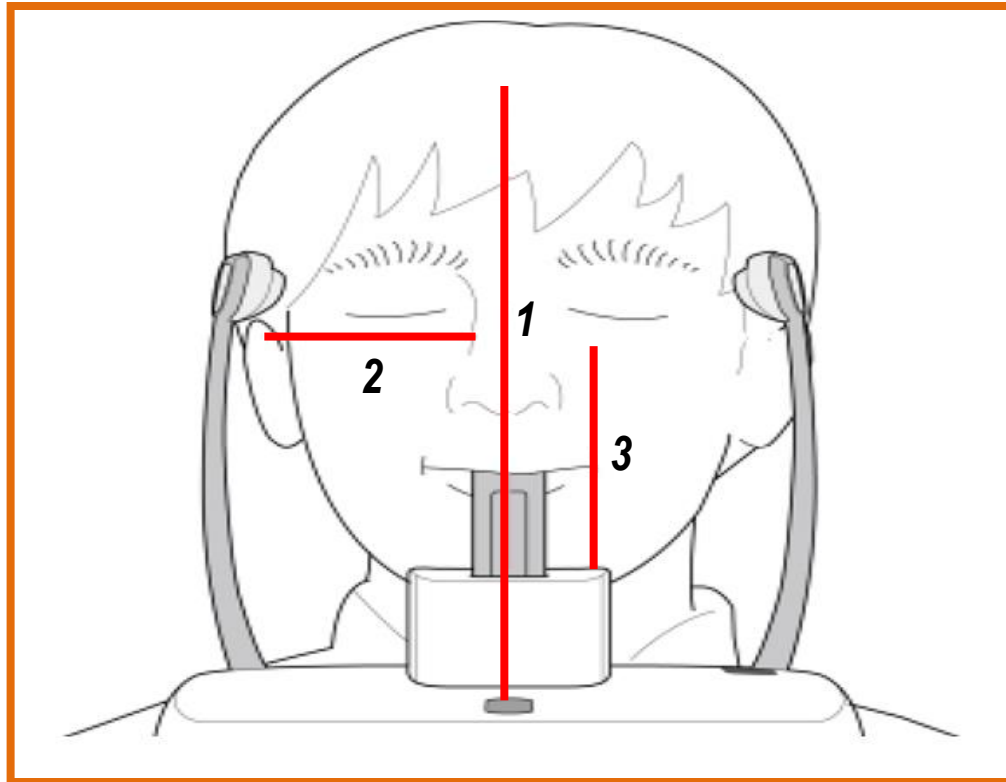

**3 Positioning Lights: 1- Mid-Sagittal Light, 2- Frankfurt Plane Light, 3- Canine Light**

## 01-II. Positioning Appliances and Laser Lights

---

**PANORAMA OBJECTIVE : “Natural Head” Position (Panorama and Bitewing Modes)**

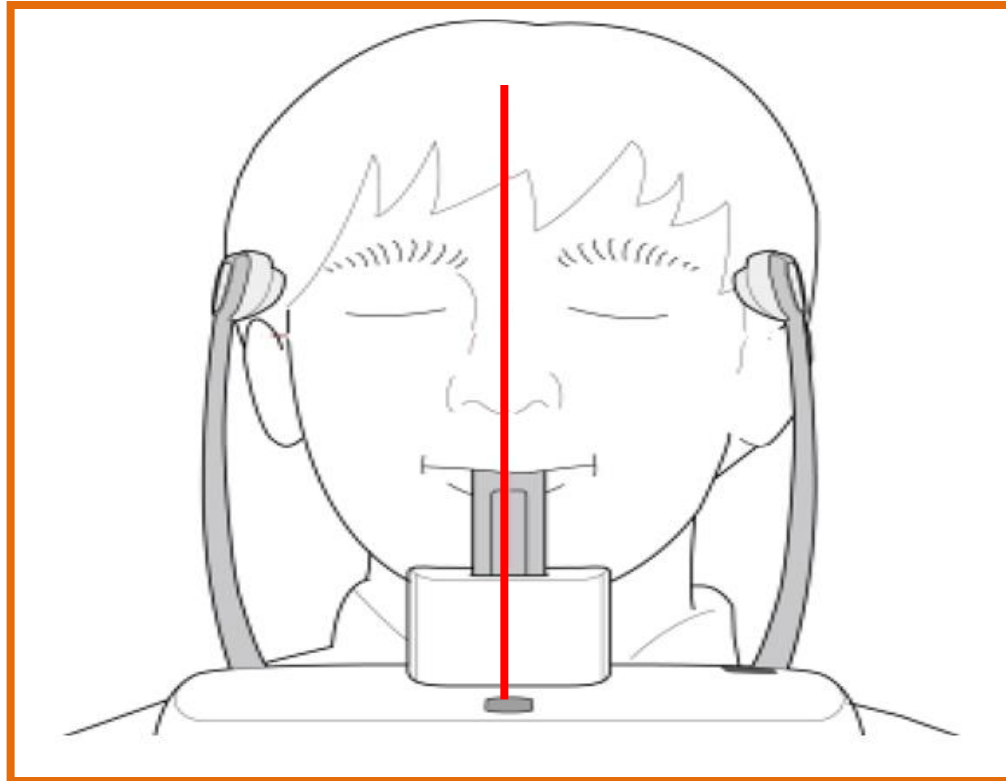

### Mid-Sagittal Vertical Laser Light:

- Center between the Eyebrows
- Center of the Philtrum

## 01-II. Positioning Appliances and Laser Lights

**PANORAMA OBJECTIVE : “Natural Head” Position (Panorama and Bitewing Modes)**

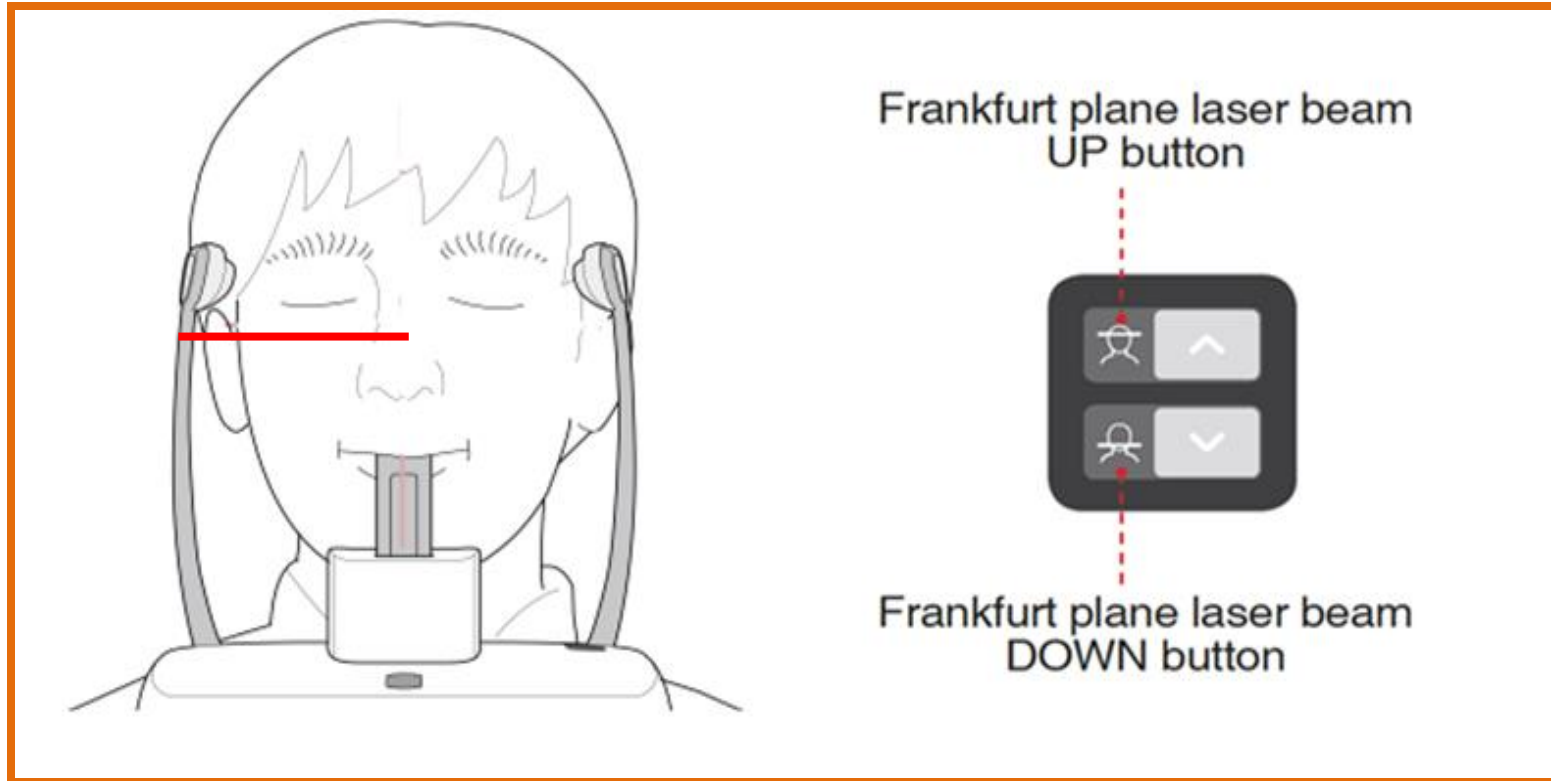

### Horizontal (Frankfurt) Laser Light

- Top of Tragus (EAM)
- Bottom of the Orbital Rim

## 01-II. Positioning Appliances and Laser Lights

**PANORAMA OBJECTIVE : “Natural Head” Position (Panorama and Bitewing Modes)**

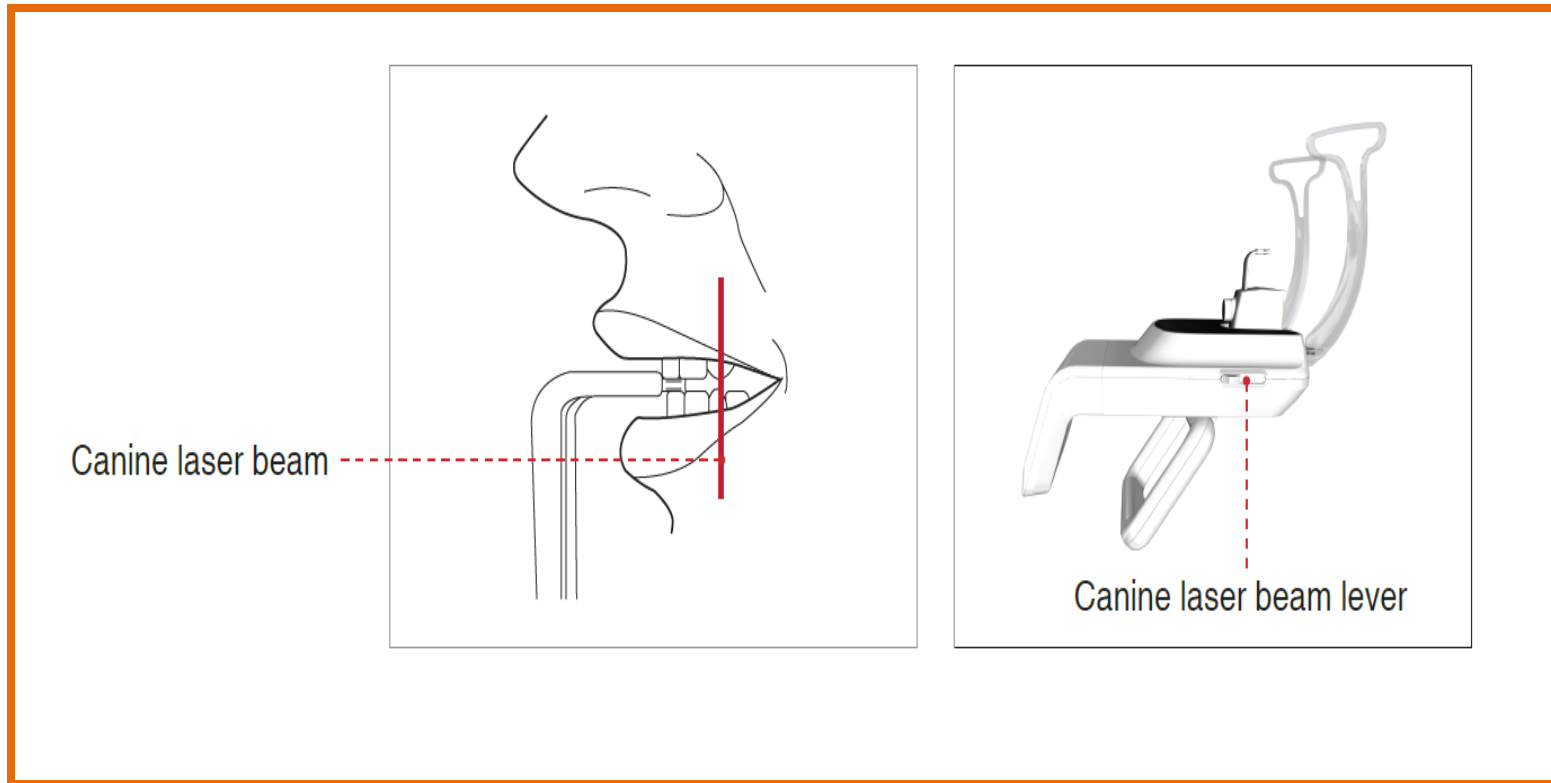

**Canine Laser Light**  
*Centered on the Maxillary Canine Tooth*

## 01-III. Proper vs Improper Positioning

---

### Correct Patient Positioning...

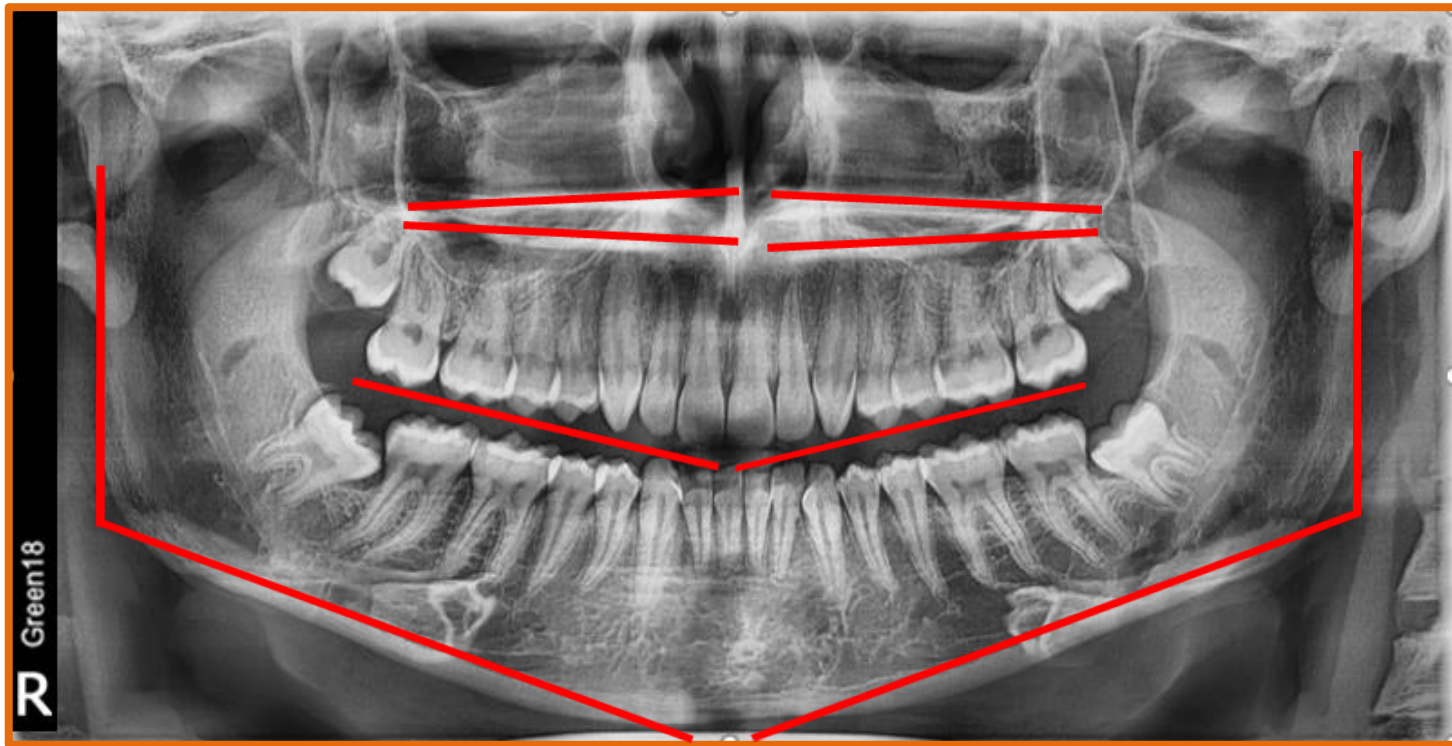

*...creates an anatomically accurate image.*

## 01-III. Proper vs Improper Positioning

---

### Incorrect Patient Positioning...



***...cannot create an anatomically accurate image.***



# 01-IV. Green CT 2 – Panorama - Operator Positioning Guide

## Preparation:

Remove metal objects from the neck up including: necklaces, eyeglasses, earrings, and any other metal objects including removable appliances such as: dentures, partials, & orthodontic retainers.



## System Initialization and Height Adjustment:

Position the patient when the red laser lights appear, and apply a new hygiene barrier. Elevate the imaging system approximately 2-3cm superior to the final height of the patient.

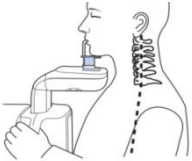

## Proper Vertical Position:

Patient should stand as fully upright as possible, with the feet positioned approx. 1" forward of vertical. Instruct the patient hold firmly to the bottom portion of the bar with palms facing towards the ceiling.

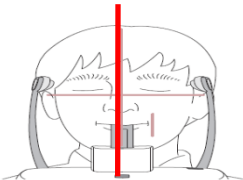

## Adjustment of the Mid-Sagittal Guide Light:

Align the Mid-Sagittal Laser light with the center of the eyebrows and the Philtrum above the upper lip.



## Adjustment of the Frankfurt Horizontal/Occlusal Guide Light:

Align the Frankfurt light to the top of the Tragus and lower Orbital Rim. Use the column adjustment button to make minor leveling adjustments. Proper alignment should generate 10-degree occlusal angle

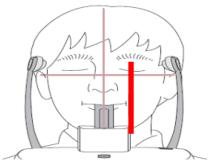

## Adjustment of the Canine Guide Light:

Use the slide knob under the shin rest to align the canine guide light to the center of the upper left canine tooth.

## 01-IV. Green CT 2 – Panorama - Patient Instruction Guide

---

**To Patient:**

**Please follow these instructions to capture a 2D Panorama Xray:**

### Patient Positioning

- 1) **Hands** – Palms facing up on the bottom of the handlebar
- 2) **Feet** – Heels aligned with column, feet shoulder width apart
- 3) **Head** – Chin on chinrest, and align teeth in the grooves of the bite stick

### Patient Instructions

- 1) Swallow and position ENTIRE tongue to the roof of your mouth
- 2) Breathe through your nose
- 3) Close your eyes
- 4) Remain still for 30 seconds



VATECH  
ASSURANCE

# 01-V. TMJ Positioning Appliances and Laser Lights

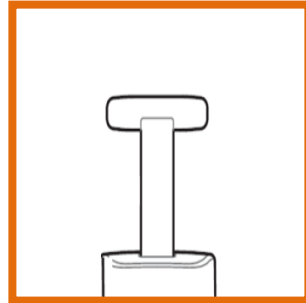

**TMJ:**  
*TMJ Appliance with  
Sinus/TMJ Chinrest*

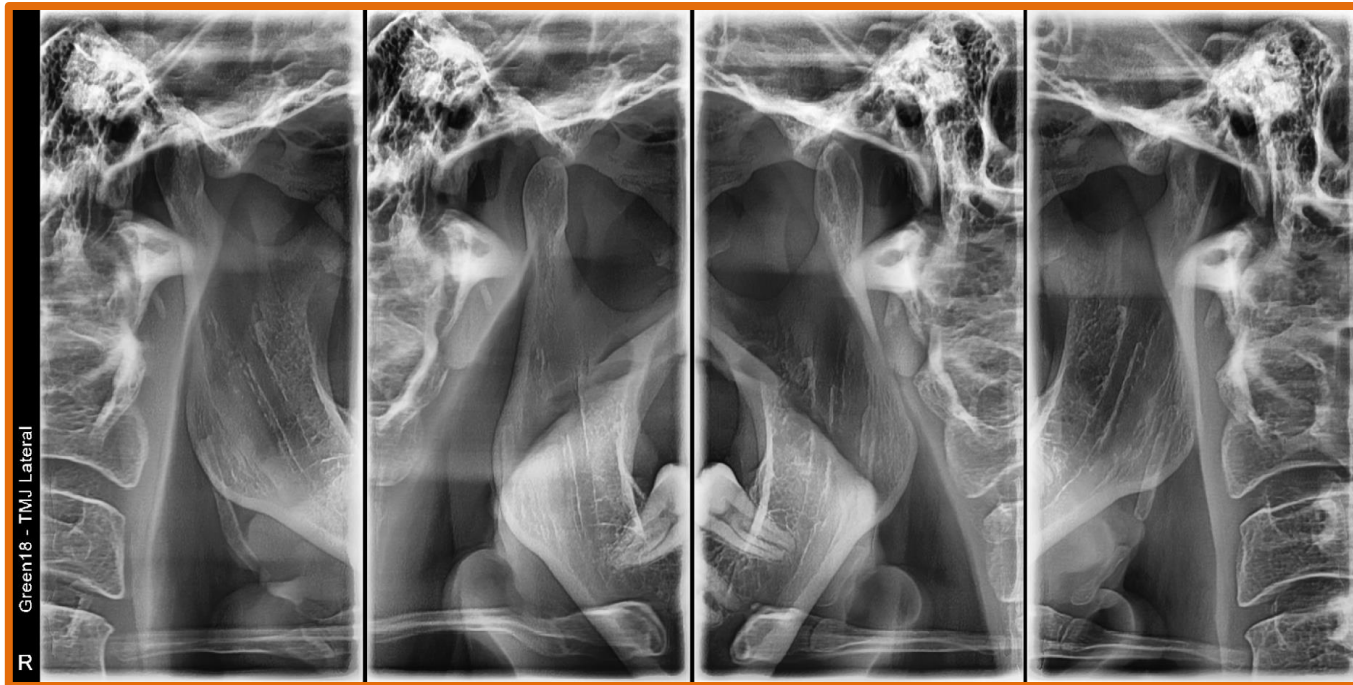

*Capture Right and Left Condyles (4 View - Open and Closed)*

## 01-V. TMJ Positioning Appliances and Laser Lights

---

**TMJ OBJECTIVE : *Capture Right and Left Condyles:***

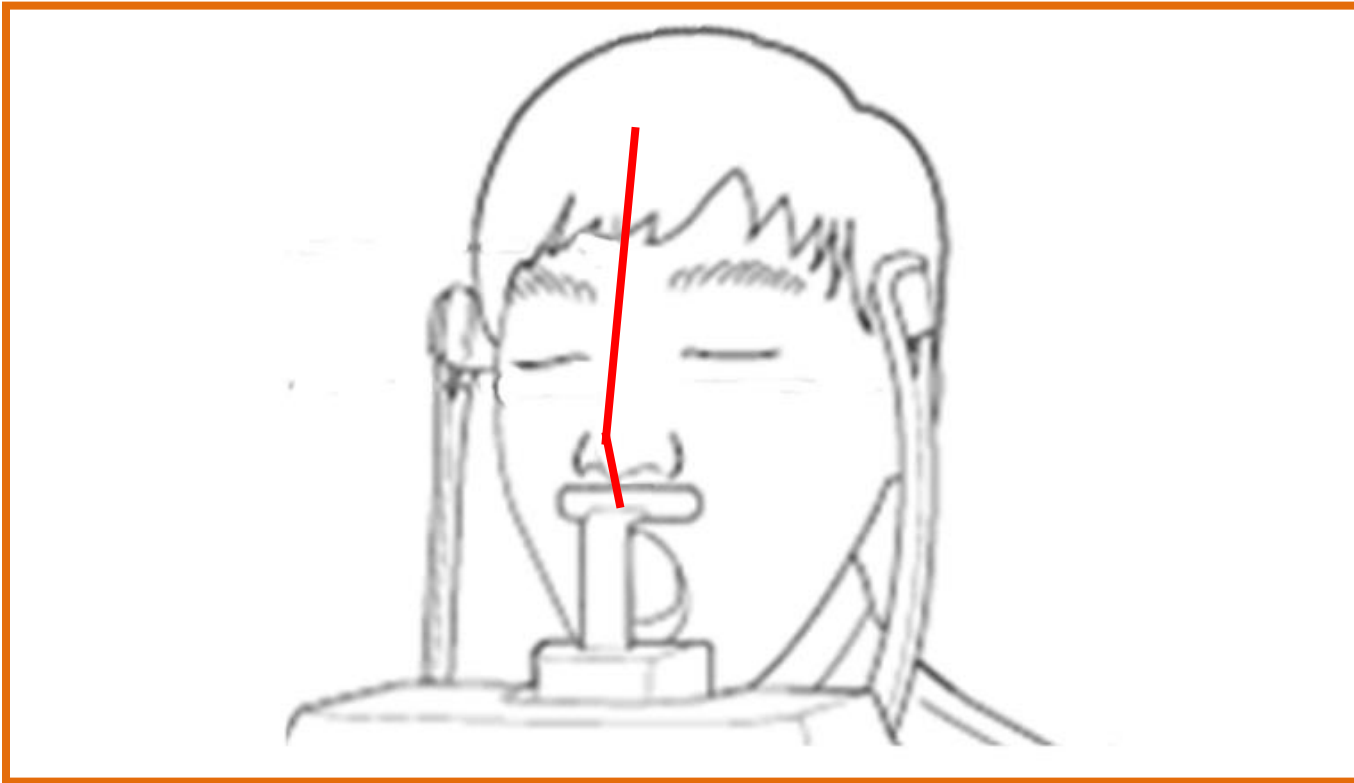

**Mid-Sagittal Vertical Laser Light:**

- *Centered between the Eyebrows*
- *Center of the Philtrum*

## 01-V. TMJ Positioning Appliances and Laser Lights

---

**TMJ OBJECTIVE : *Capture Right and Left Condyles:***

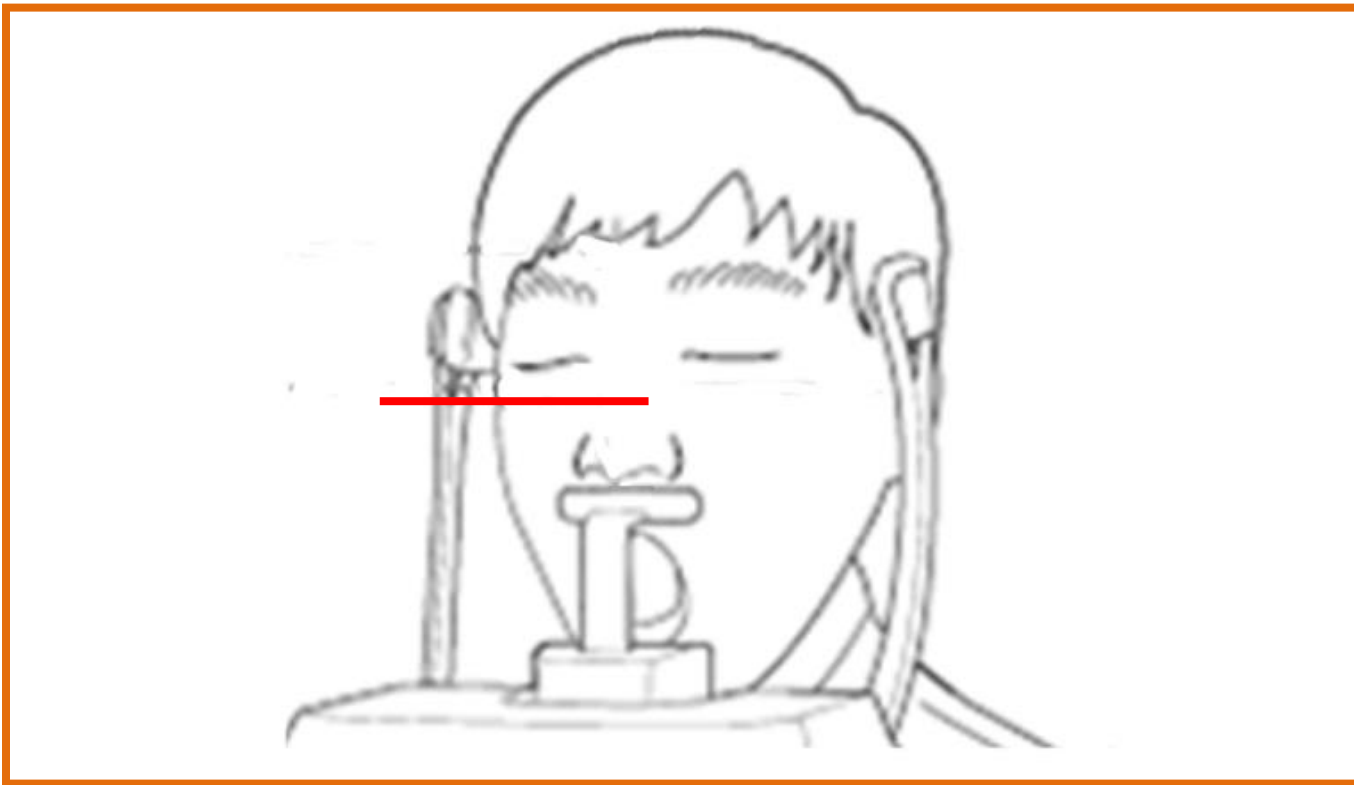

**Horizontal (Frankfurt) Laser Light:**

*Top of Tragus (EAM)  
Bottom of the Orbital Rim*

## 01-VI. Sinus Positioning Appliances and Laser Lights

---



**Sinus:**  
*Sinus/TMJ Appliance with  
Low Profile Chinrest*

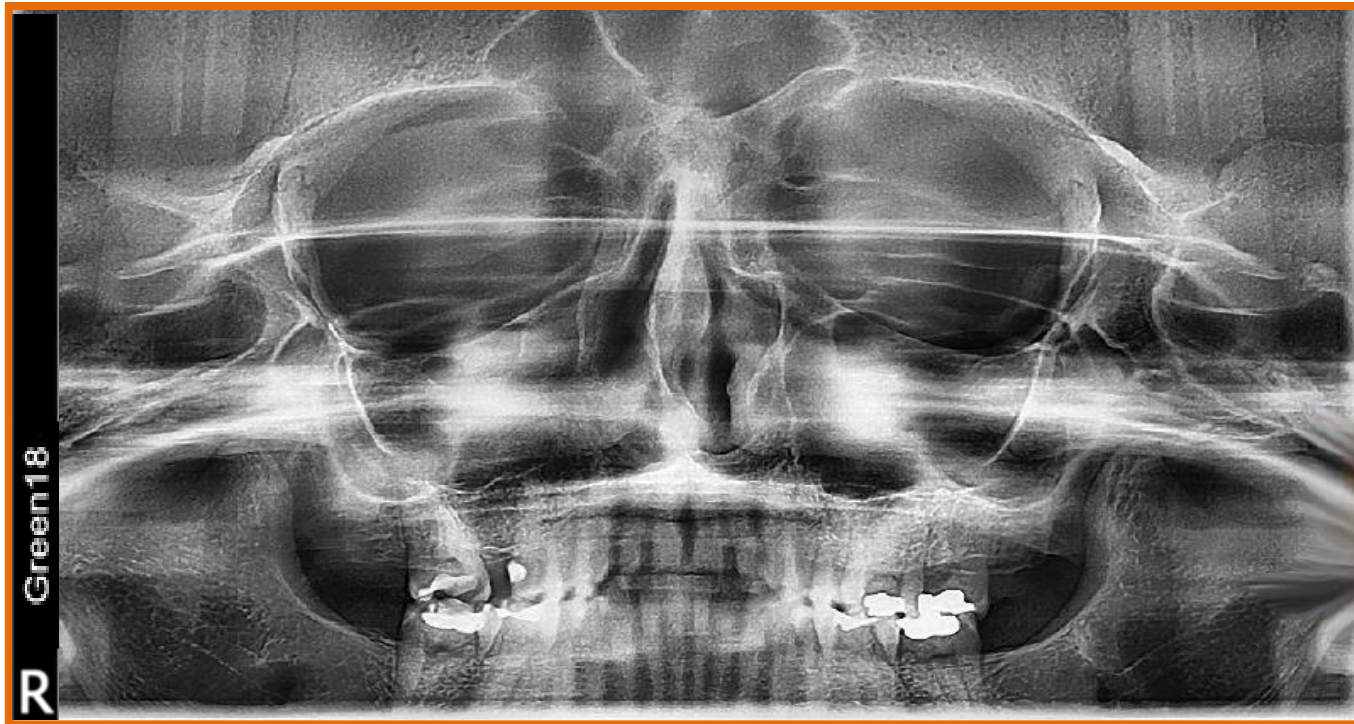

## 01-VI. Sinus Positioning Appliances and Laser Lights

---

### SINUS OBJECTIVE : *“Open View” of Sinus Cavity*

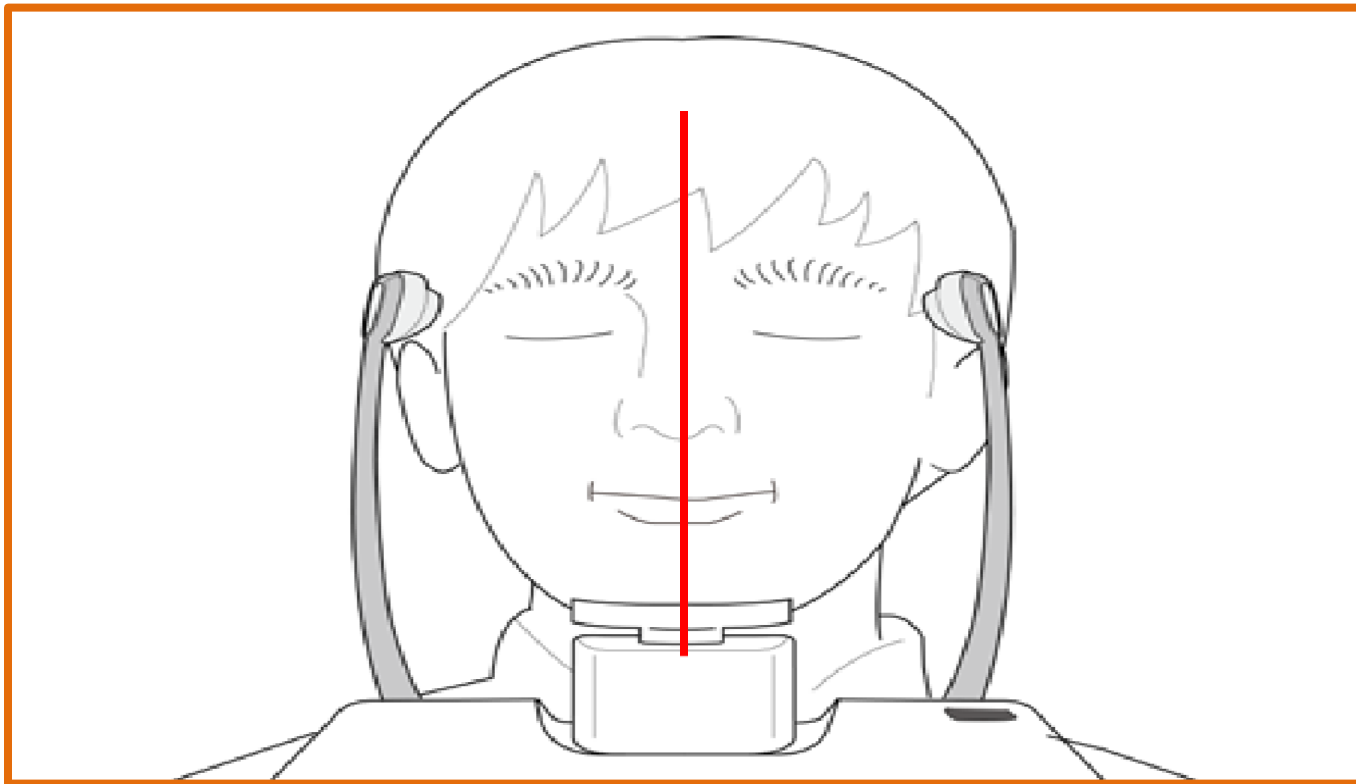

#### Mid-Sagittal Vertical Laser Light:

- *Centered between the Eyebrows*

- *Center of Philtrum*

## 01-VI. Sinus Positioning Appliances and Laser Lights

---

### SINUS OBJECTIVE : “Open View” of Sinus Cavity

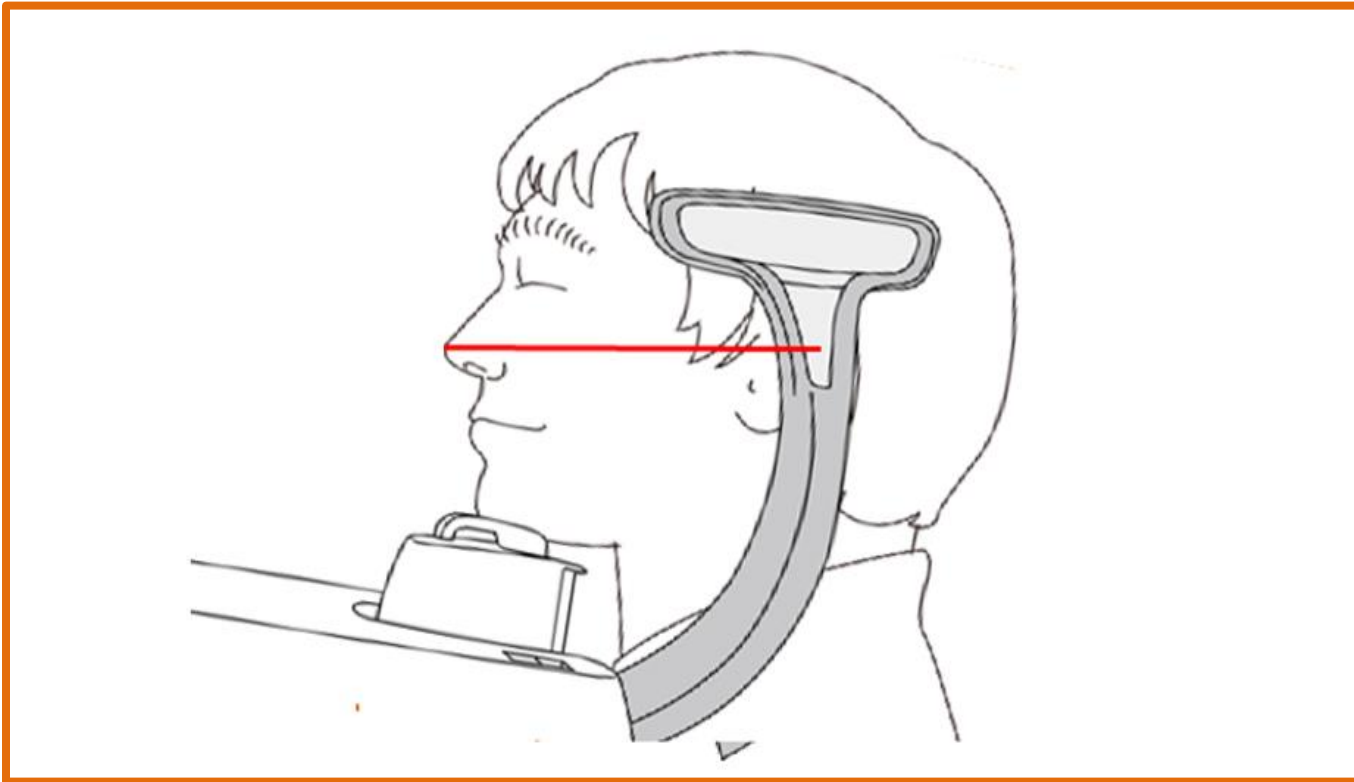

#### Horizontal (Frankfurt) Laser Light

- Top of the Ear
- Tip of the Nose



## 02. 3D Imaging

---



3D (CBCT) Modality

## 02-I. 3D Capture Software Navigation

### 3D Image Capture Software – *Pre-Capture Options:*

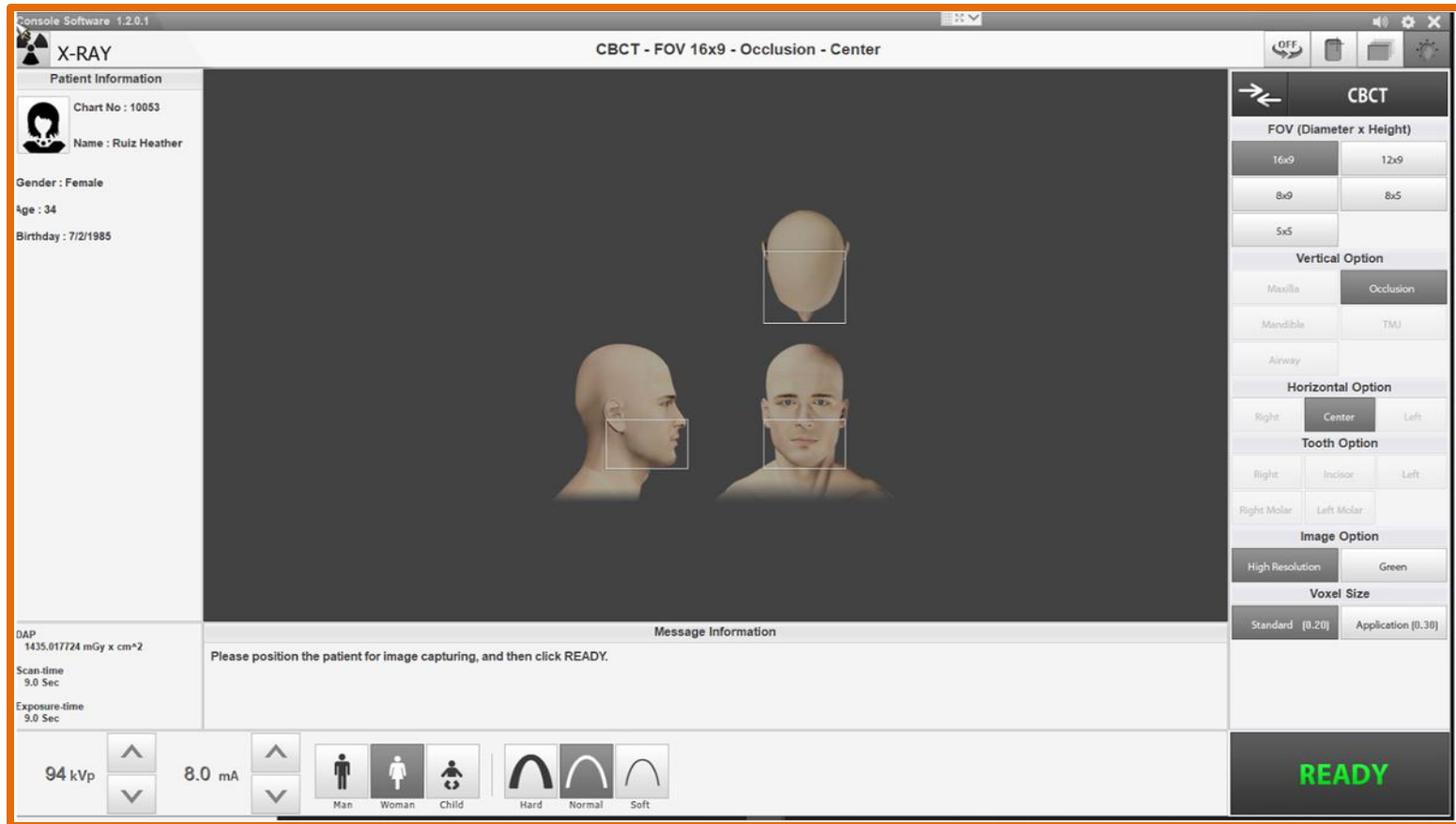

## 02-I. 3D Capture Software Navigation

### 3D Image Capture Software – *Post Capture Options:*

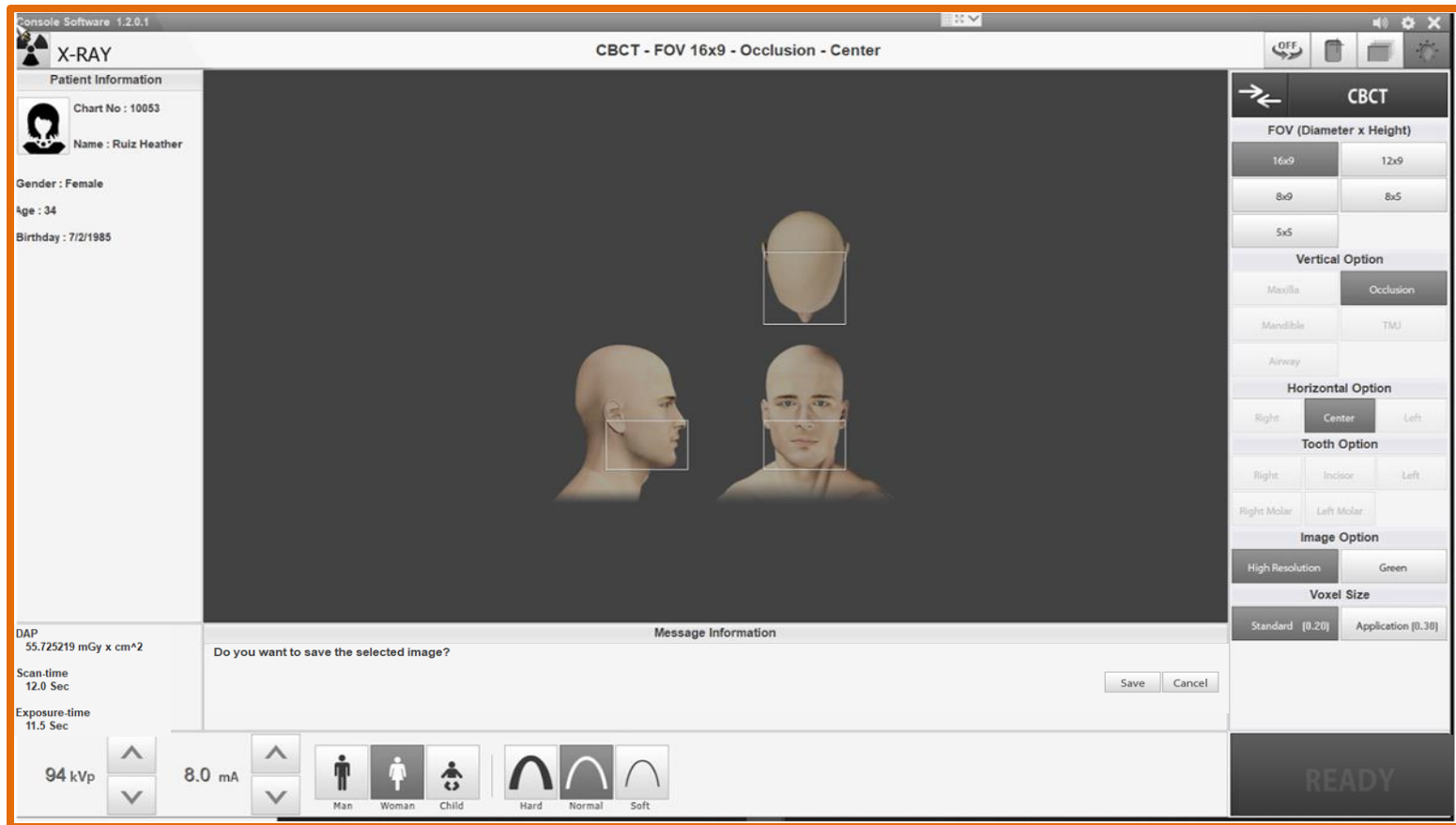

## 02-II. 3D Positioning Appliances and Laser Lights

---

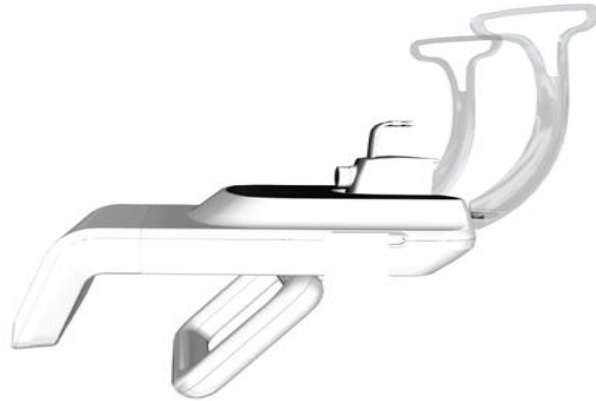

← *Chin Rest with Bite Stick*

And depending on scan protocol...(i.e. Edentulous, Full Occlusion and Airway )

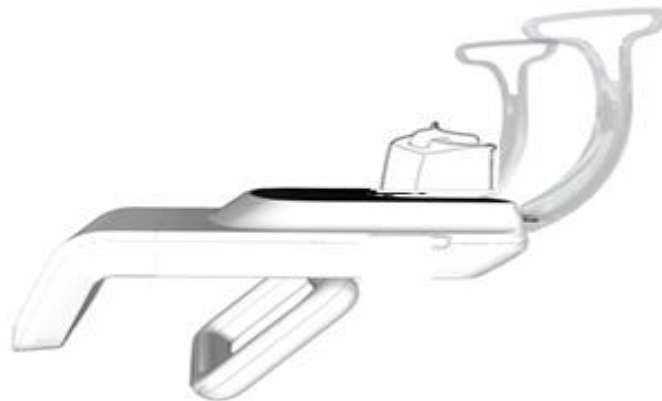

← *Chin Rest Only or with  
3D Chin Cup*

## 02-II. 3D Positioning Appliances and Laser Lights

---

### All CBCT Scans



*Align Sagittal laser light thru center of the anatomy*

## 02-II. 3D Positioning Appliances and Laser Lights

---

### ROI Objective: *Occlusal (Dual) Arch*



***Axial Light***

***Axial Light will project between Upper and Lower Lips (16x09, 12x09, 08x09)***

## 02-II. 3D Positioning Appliances and Laser Lights

---

### ROI Objective: *Maxillary Arch*

*Axial Light*

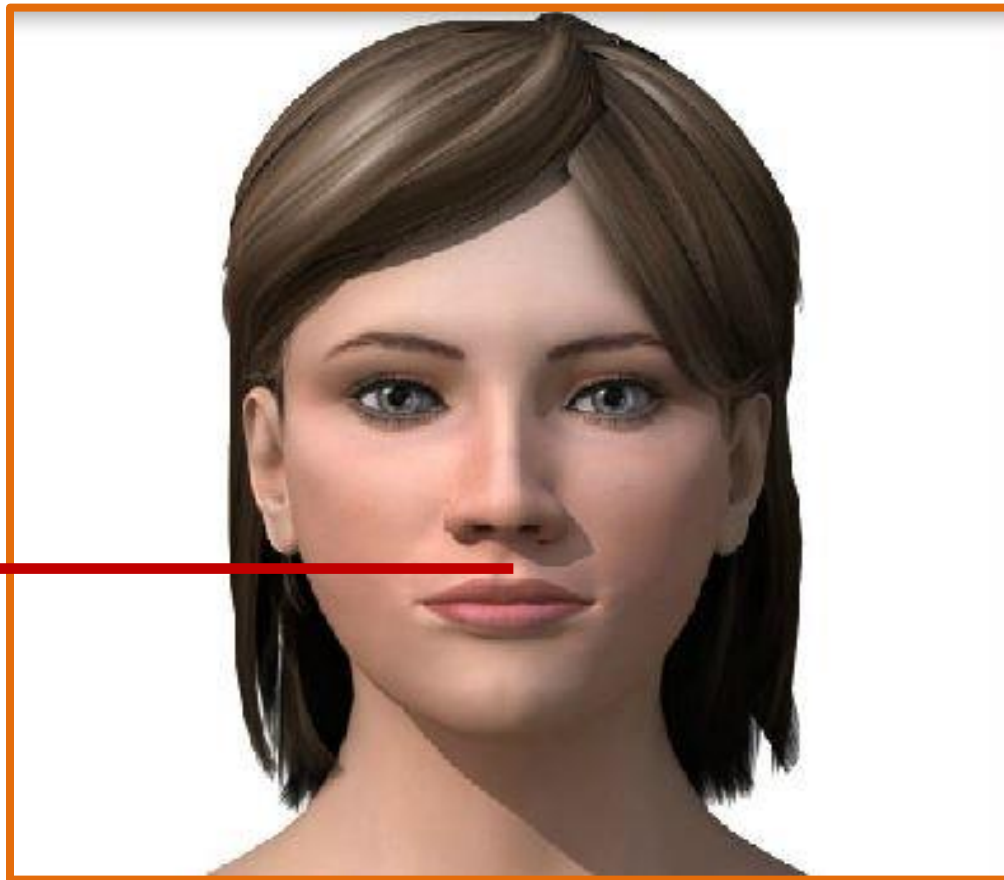

*Axial Light will project near Upper Lip (8x5 and 5x5 Only)*

## 02-II. 3D Positioning Appliances and Laser Lights

---

### ROI Objective: *Mandibular Arch*

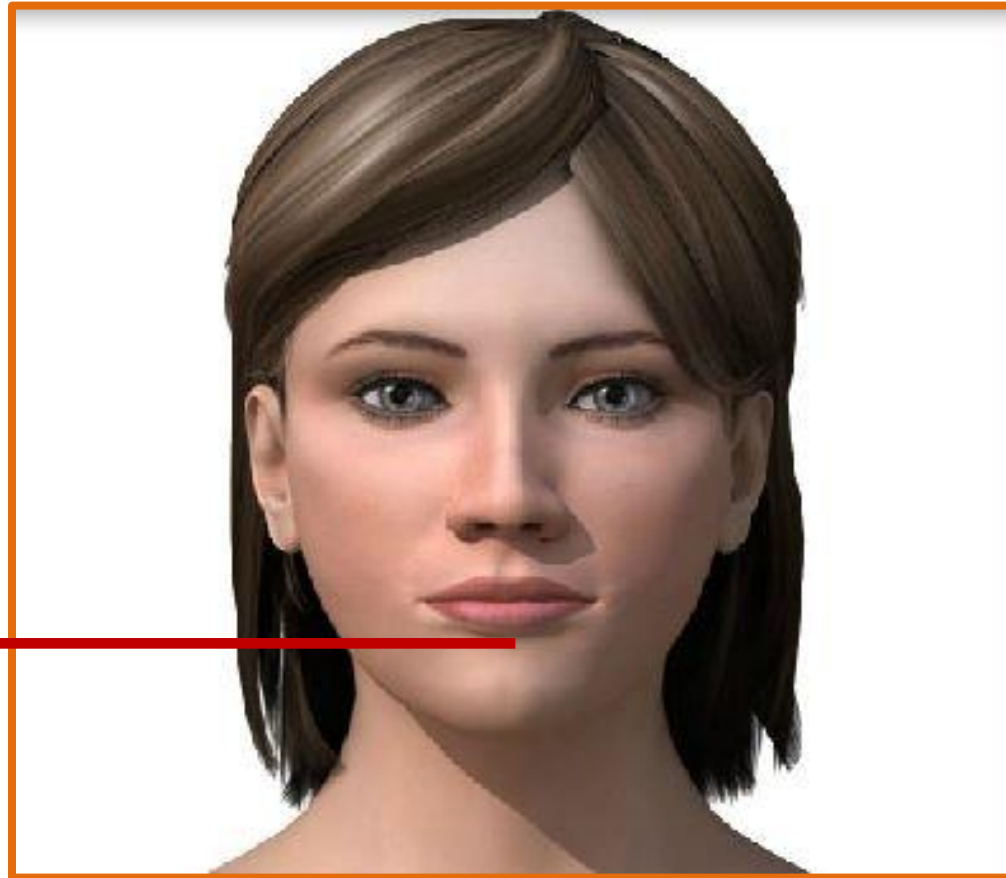

***Axial Light***

***Axial Light will project near Lower Lip (8x5 and 5x5 Only)***



## 02-III. Field Of View and Regions Of Interest

---

**Field Of View (FOV) : 16 x 09 cm**

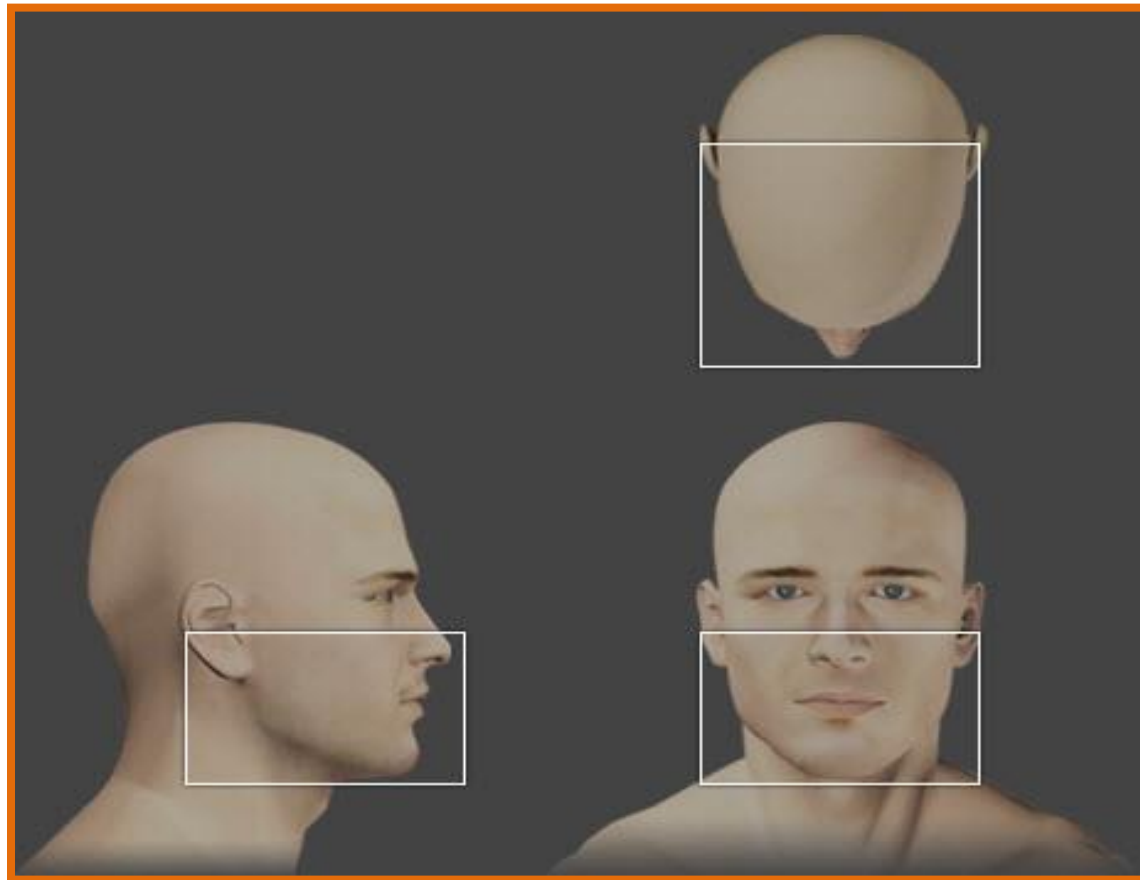

**ROI includes - Dentition, Airway, TMJ**

## 02-III. Field Of View and Regions Of Interest

---

**Field Of View (FOV) : 12 x 09 cm**

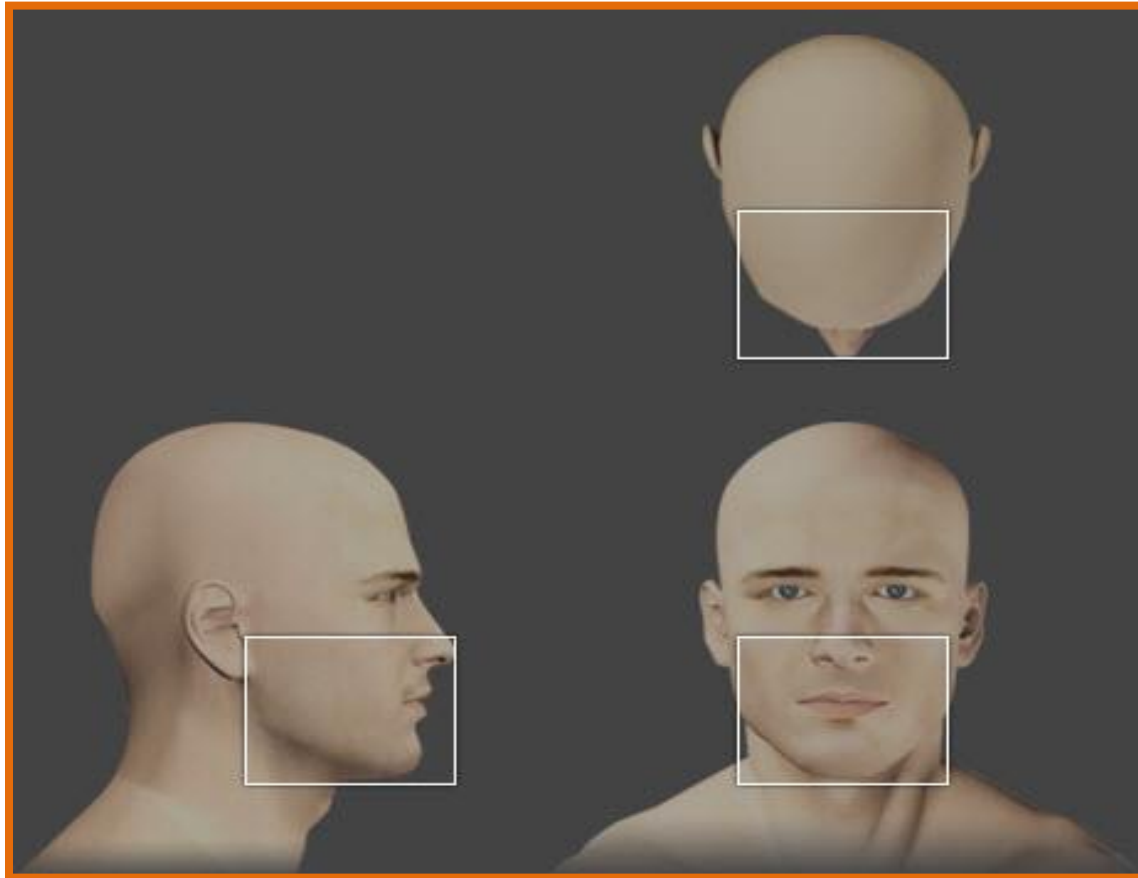

**ROI Includes: *Entire Dentition with 3rds (if applicable)***

## 02-III. Field Of View and Regions Of Interest

---

**Field Of View (FOV) : 08 x 09 cm**

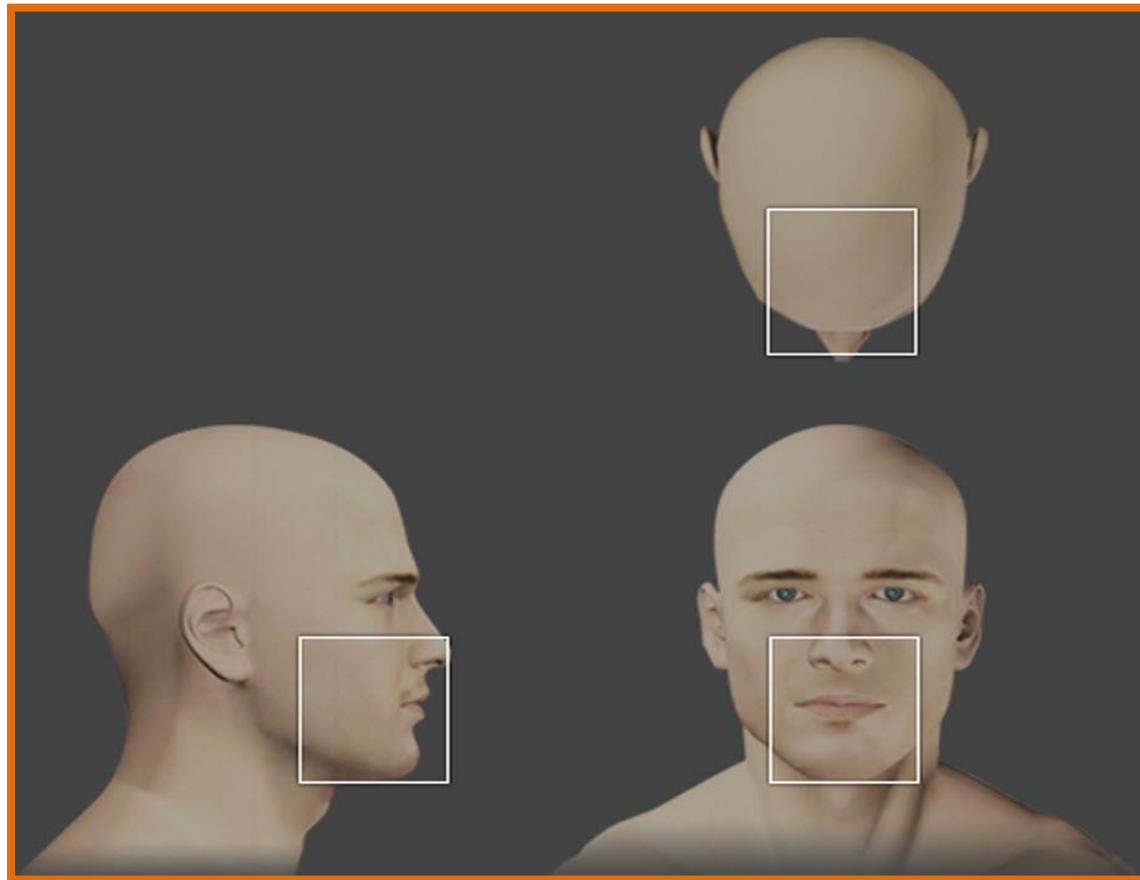

**ROI Includes: *Central Dentition, and TMJ (R or L)***

## 02-III. Field Of View and Regions Of Interest

---

**Field Of View (FOV) : 08 x 05 cm**

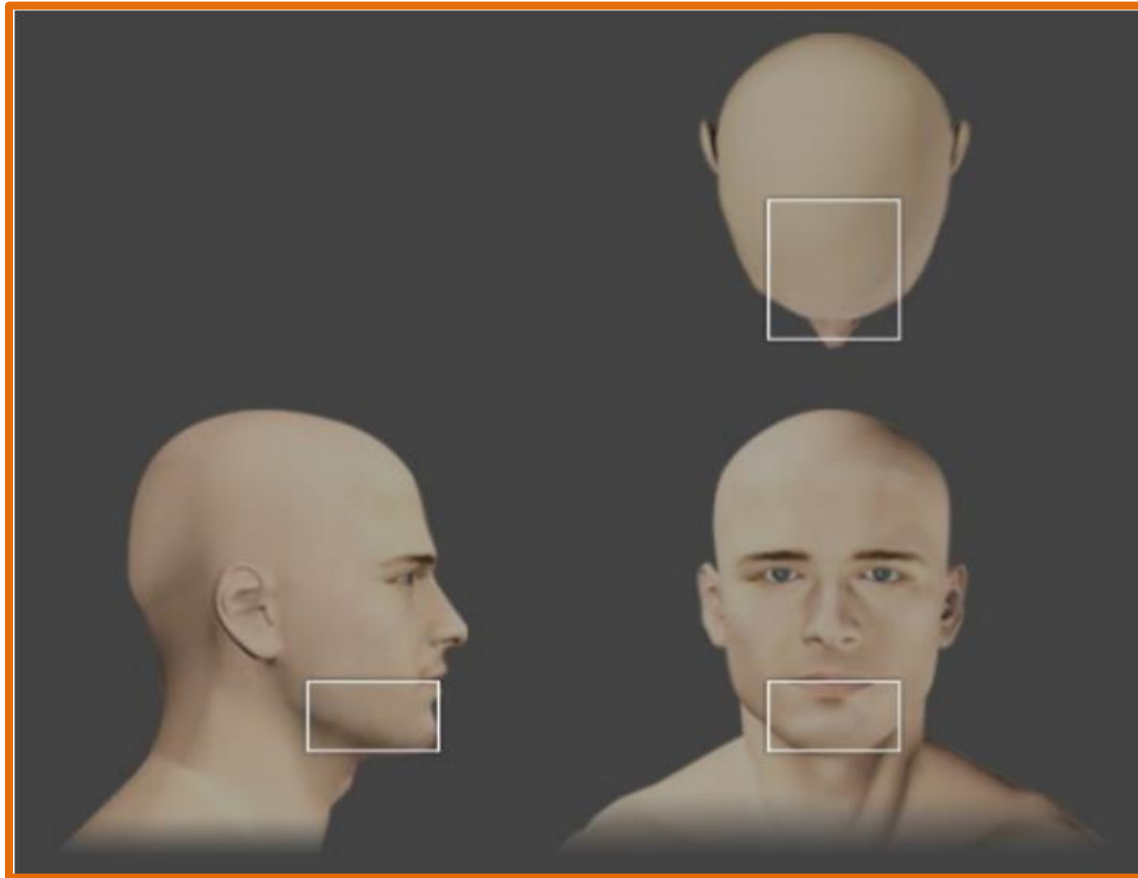

**ROI Includes: Maxilla/ Mandible - *Right, Center, Left***

## 02-III. Field Of View and Regions Of Interest

---

**Field Of View (FOV) : 05 x 05 cm**

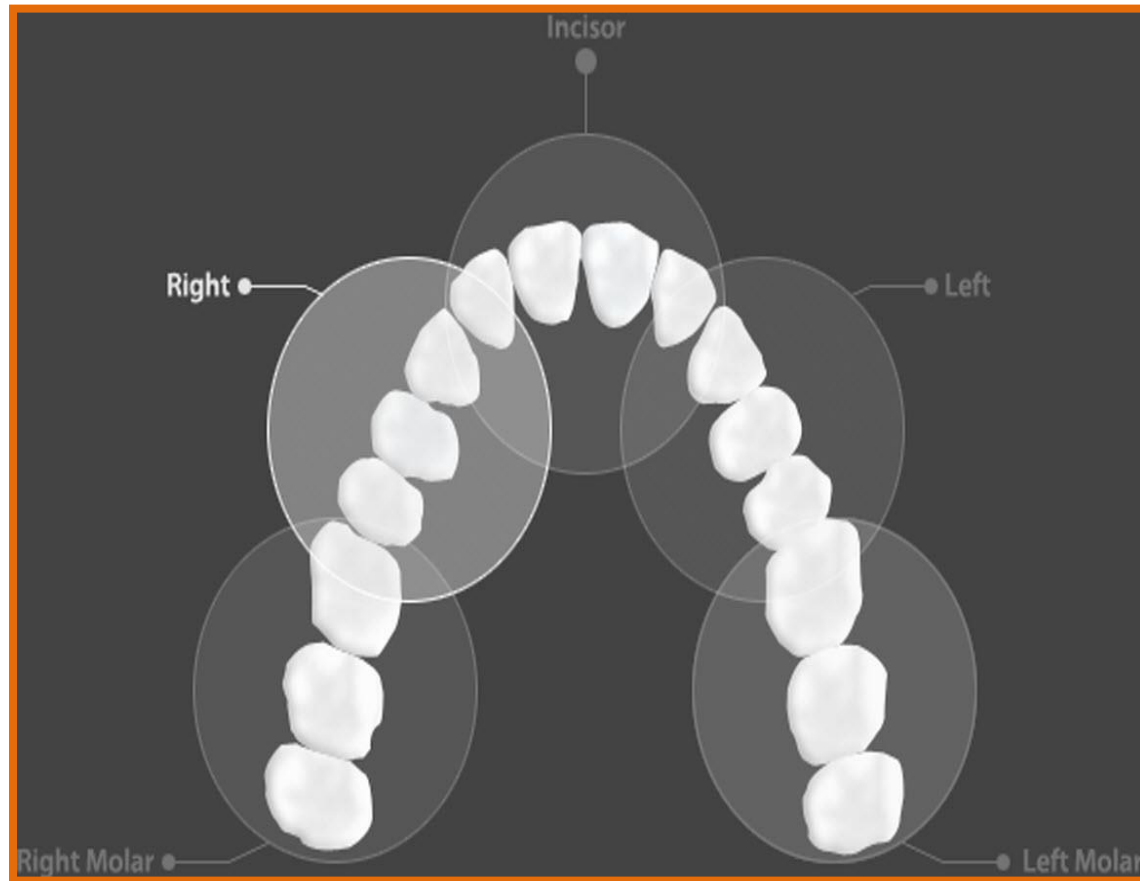

**ROI Includes: *Right Molar, Right, Incisor, Left and Left Molar***

## 02-IV. Proper vs Improper Positioning

### Correct Patient Positioning...

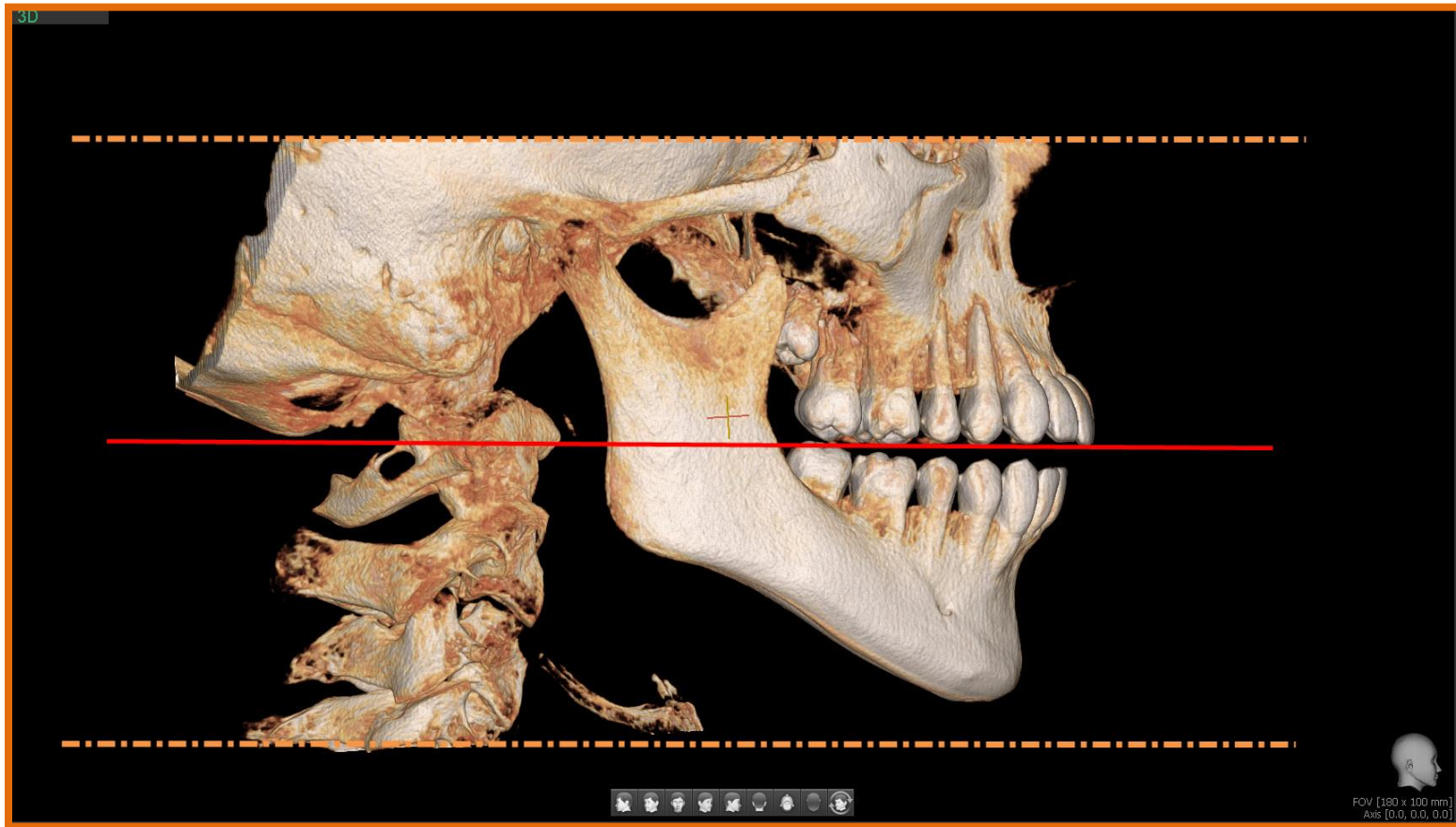

*...captures an accurate 3D Scan.*

## 02-IV. Proper vs Improper Positioning

### Pan Curve Based on Adjusted Axial Plane

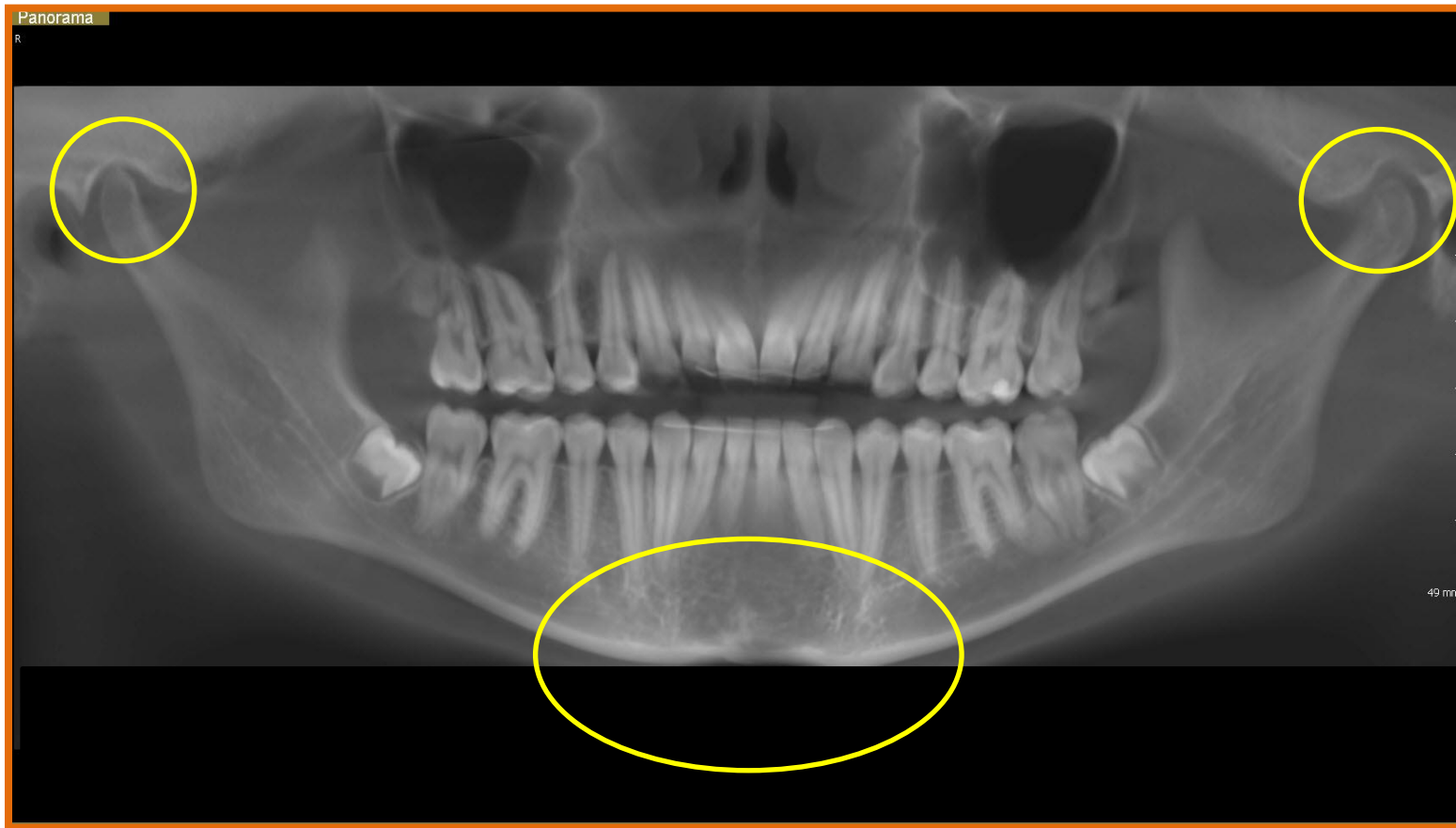

*...captures an accurate 3D Scan.*

## 02-IV. Proper vs Improper Positioning

### Incorrect Patient Positioning...

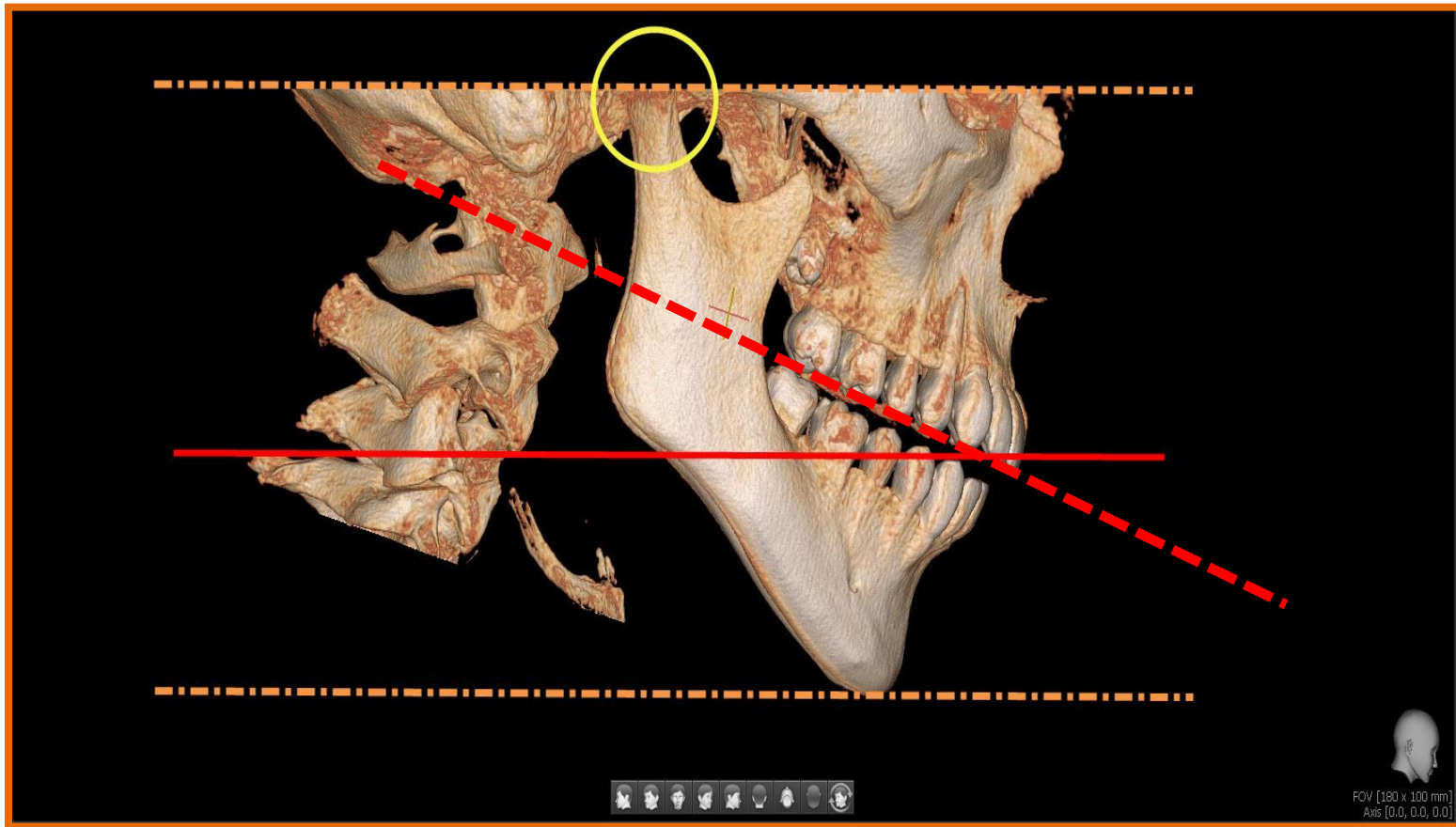

*...may capture an unusable CBCT scan*



## 02-IV. Proper vs Improper Positioning

### Pan Curve Based on Non-Adjusted Axial Plane

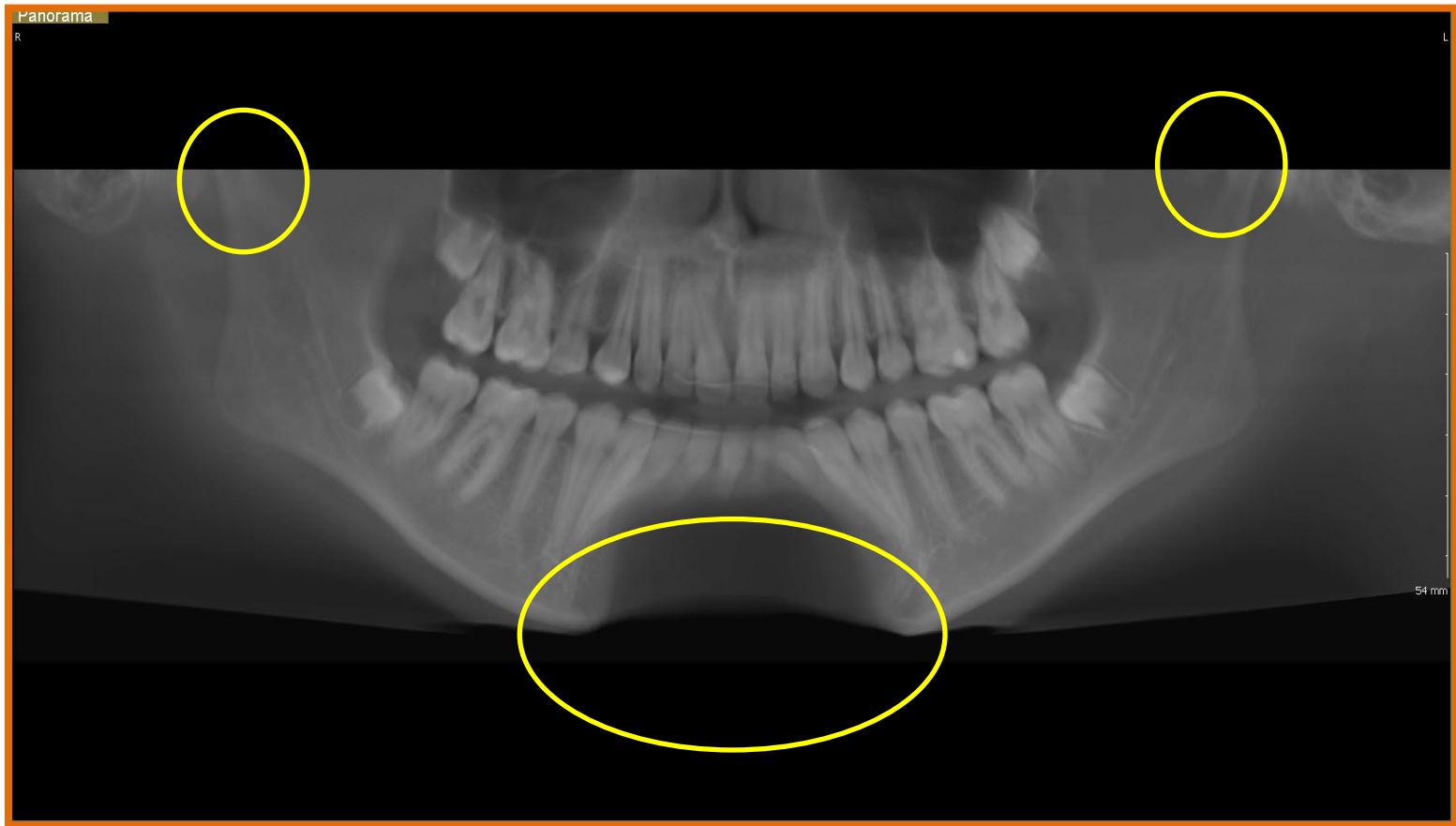

*...may capture an unusable CBCT scan*

## 02-V. Green CT 2 – CBCT Operator Positioning Guide

### Preparation:

Remove metal objects from the neck up including: necklaces, eyeglasses, earrings, and any other metal objects including removable appliances such as: dentures, partials, & orthodontic retainers.



### System Initialization and Height Adjustment:

Position the patient when the red laser lights appear, and apply a fresh hygiene barrier. Elevate the imaging system approximately 2-3cm superior to final height of the patient.



### Proper Vertical Position:

Patient should stand as fully upright as possible with the feet positioned approx. 1" forward of vertical. Instruct the patient hold firmly to the bottom portion of the bar with the palms facing to wards the ceiling. Chin on chin rest with teeth aligned on the bite stick notch.



### Mid-Sagittal Laser Guide Light:

- Mid-Sagittal Guide light aligns with the center of the eyebrows the philtrum. (below the nose)



### Axial Laser Guide Light:

Dual Arch – Verify Axial guide light projects at occlusal plane

Mx.\Mn. – Verify Axial guide light projects above occlusal for Mx, below the occlusal for Mn.

## 02-V. Green CT 2 – CBCT Patient Instruction Guide

---

**To Patient:**

**Please follow these instructions to capture a CBCT Scan:**

### Patient Positioning

- 1) **Hands** – Palms facing up on the bottom of the handlebar
- 2) **Feet** – Heels aligned with column, feet shoulder width apart
- 3) **Head** – Chin on chinrest, and align teeth in the grooves of the bite stick

### Patient Instructions

- 1) Swallow and keep tongue at rest in your mouth
- 2) Breathe slowly through your nose
- 3) Close your eyes
- 4) Remain still for 30 seconds



VATECH  
ASSURANCE

### 03. Addendum – Ceph, Stone Model, Ceph, Airway and TMJ

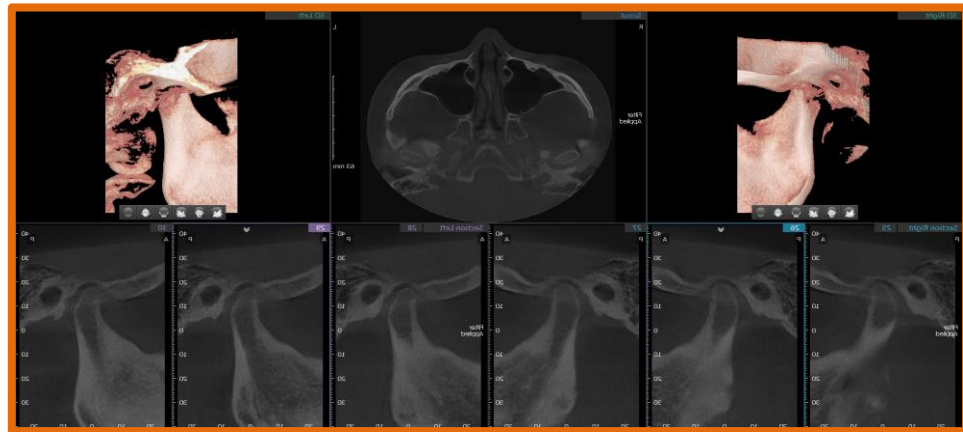
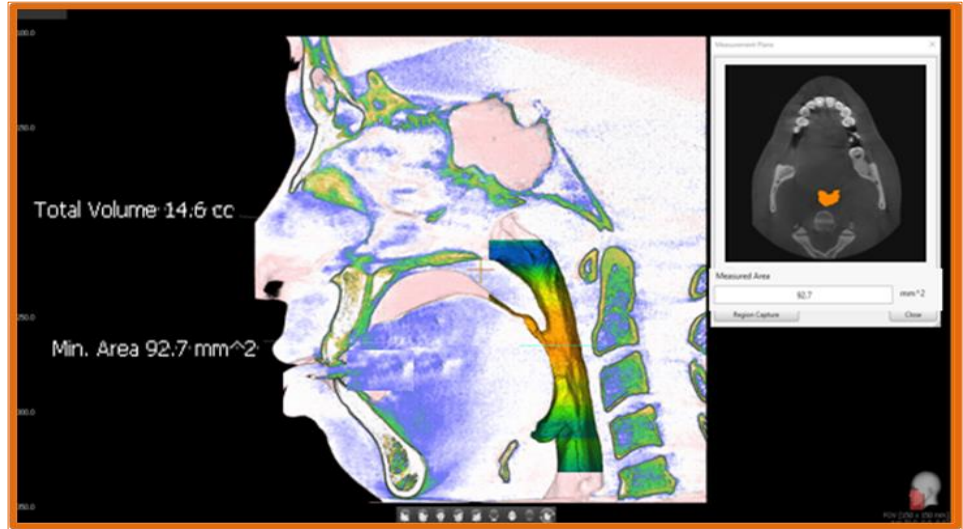

# 03-I. 3D TMJ/AIRWAY Scan Protocol

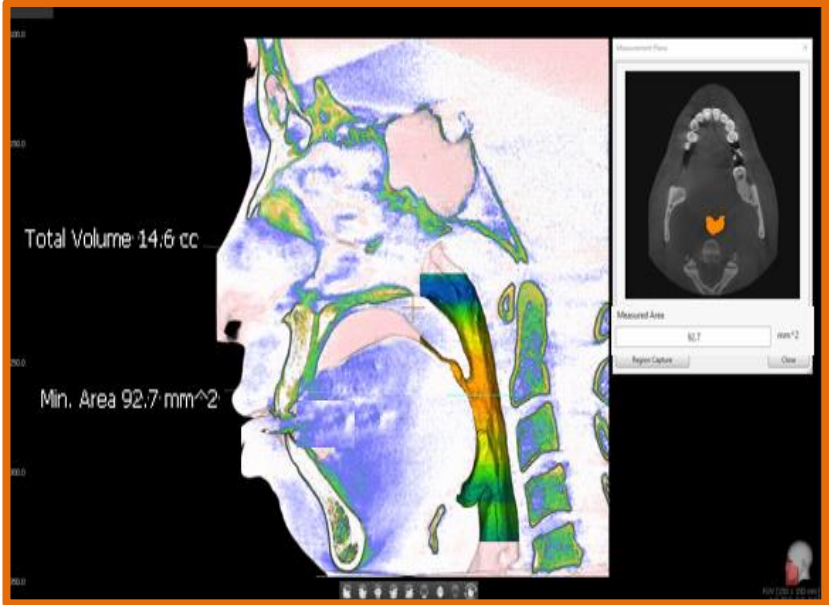
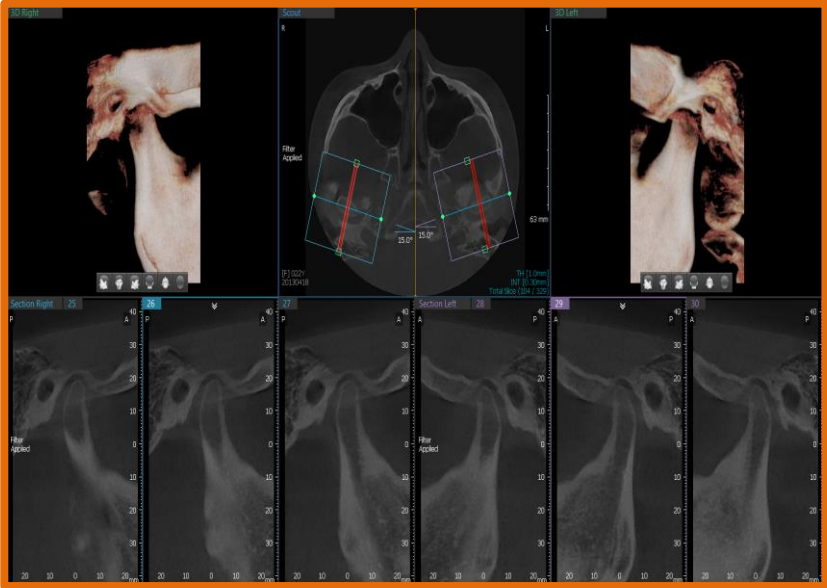

# 03-I. 3D TMJ/AIRWAY Scan Protocol

## 3D TMJ/Airway Image Capture Software – *Pre-Capture Options:*

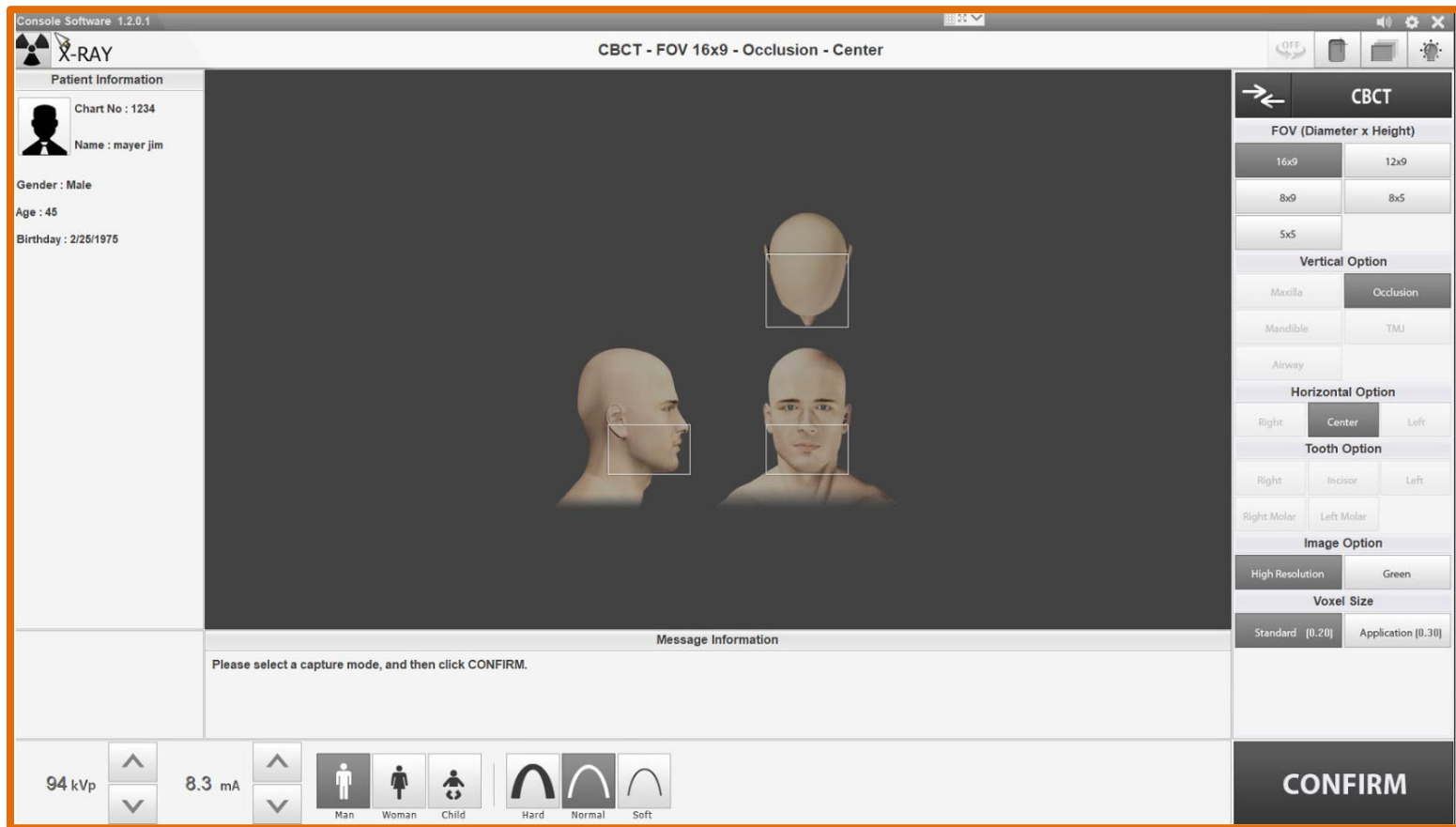

# 03-I. 3D TMJ/AIRWAY Scan Protocol

## 3D TMJ/Airway Image Capture Software – *Post Capture Options:*

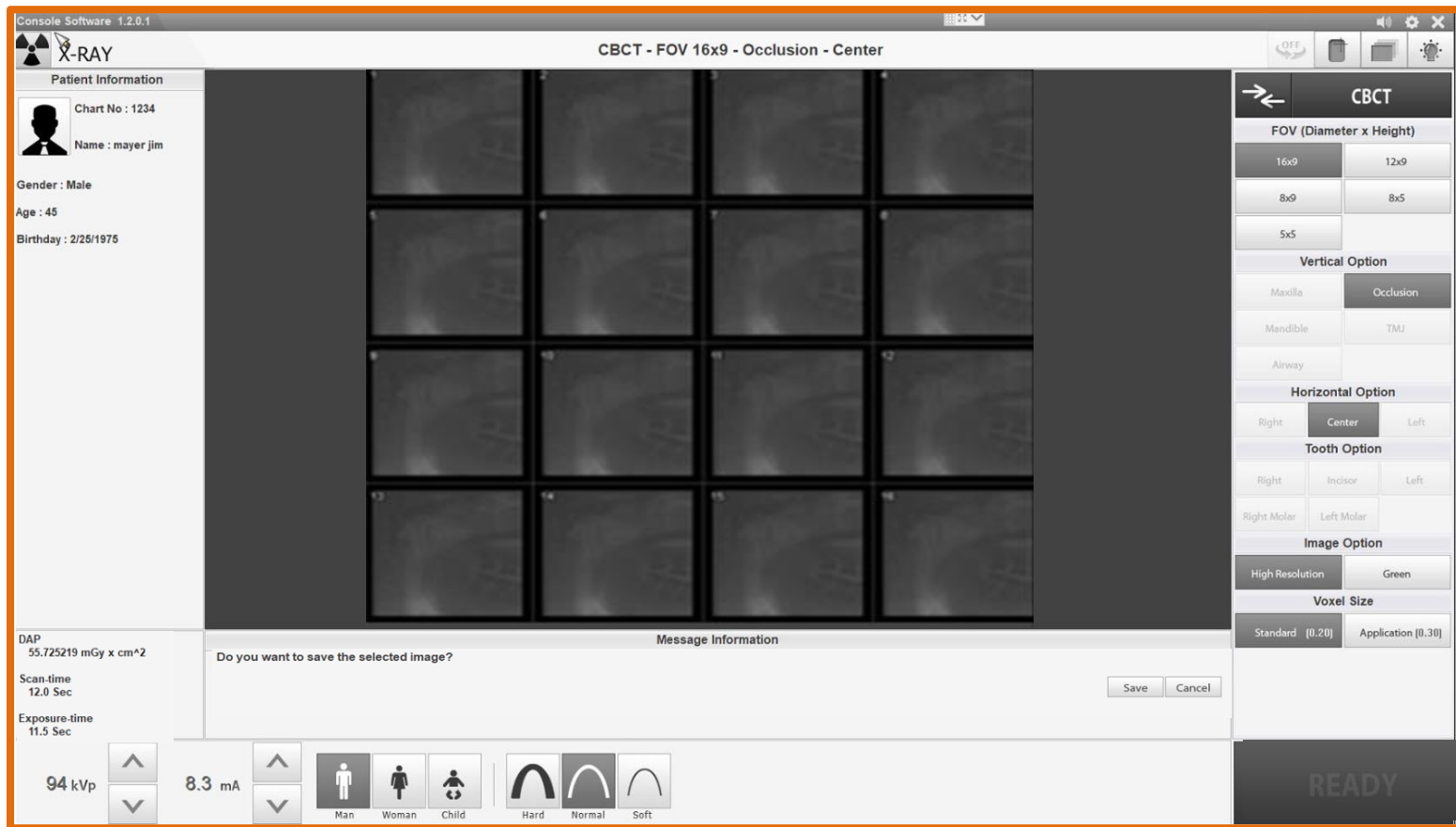

# 03-I. 3D TMJ/AIRWAY – Operator Positioning Guide

## Preparation:

Remove metal objects from the neck up including: necklaces, eyeglasses, earrings, and any other metal objects including removable appliances such as: dentures, partials, & orthodontic retainers.

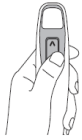

## System Initialization and Height Adjustment:

Position the patient when the red laser lights appear, and apply a fresh hygiene barrier. Elevate the imaging system approximately 2-3cm superior to final height of the patient.



## Proper Vertical Position:

Patient should stand as fully upright as possible with the feet positioned approx. 1" forward of vertical. Instruct the patient hold firmly to the bottom portion of the bar with the palms facing towards the ceiling

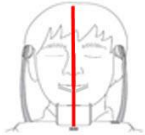

## Mid-Sagittal Guide Light:

Align the Mid-Sagittal Laser light with the center of the eyebrows the philtrum above the upper lip



## Axial Guide Light:

Verify Axial light projects on targeted anatomy in a vertical direction (i.e - lips for dual arch cbct)

## Basic Principle of Dental CT Image Acquisition:

The Positioning lights are intended to identify a 'target' region, whether it's a dual arch, or single arch or single tooth  
Occlusal plane should be parallel to the floor



## 03-I. 3D TMJ/AIRWAY Patient Instruction Guide

---

### To Patient:

Please follow these instructions to capture a 3D TMJ/Airway Xray:

### Patient Positioning

- 1) **Hands** – Palms facing up on the bottom of the handle bar
- 2) **Feet** – Heels aligned with column, feet shoulder width apart
- 3) **Head** – Chin on chinrest, and align teeth in the grooves of the bite stick

### Patient Instructions

- 1) Swallow and tongue remains at rest in your mouth
- 2) Bite down on back teeth
- 3) Breathe through your nose
- 4) Close your eyes
- 5) Remain still for 30 seconds



VATECH  
ASSURANCE

# 03-II. Stone Model Scanning

---



## 03-II. Stone Model Scanning

### 3D Model Capture Software – *Pre-Capture Options:*

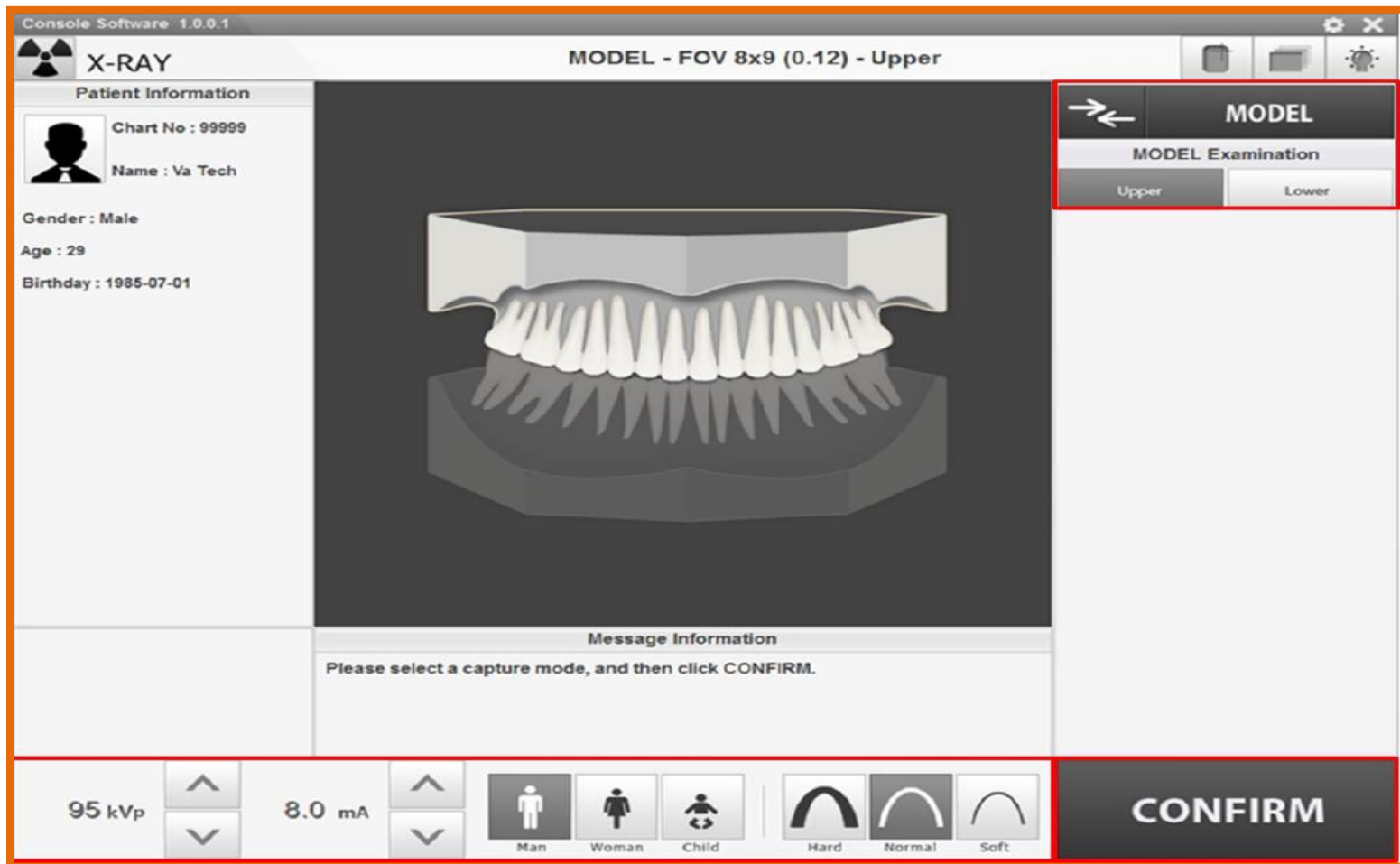

## 03-II. Stone Model Scanning

### 3D Model Capture Software – *Pre-Capture Options:*

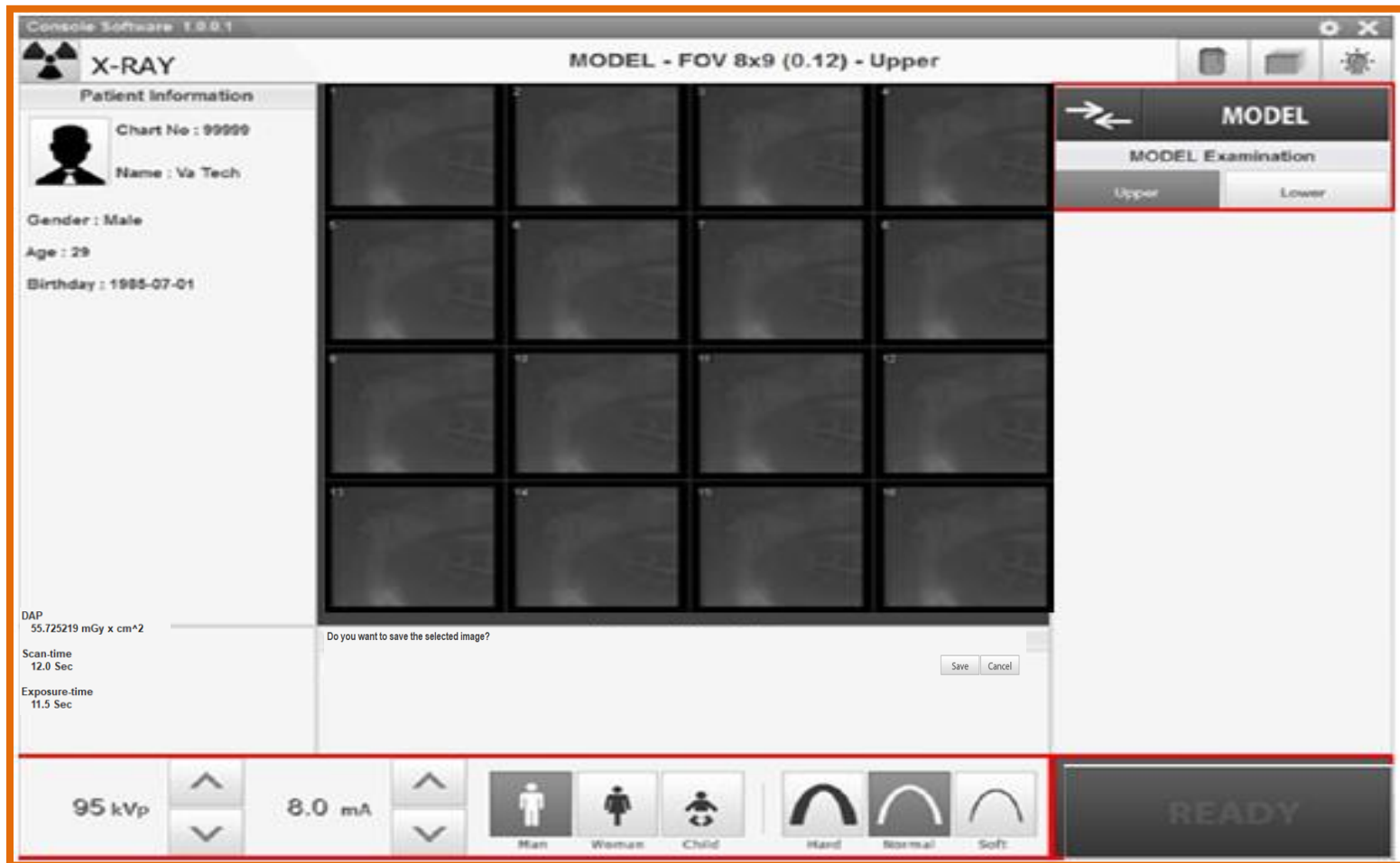

## 03-II. Stone Model Scanning

---

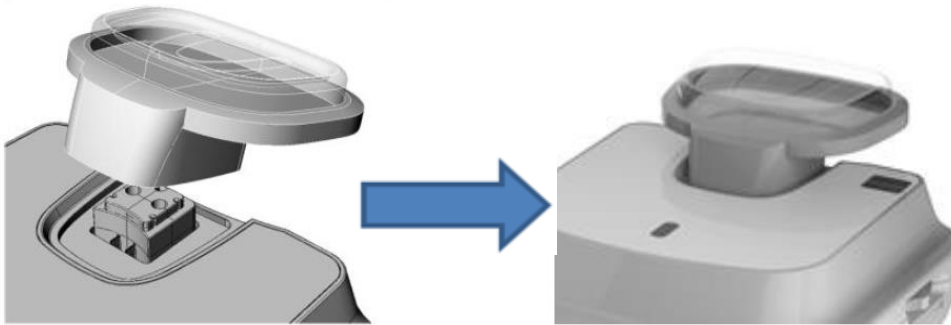

*Model Scan Jig Installation*



*Model Laser Beam Alignment and Placement*

# 03-III. Lateral Ceph Image Capture

## 2D Ceph Image:

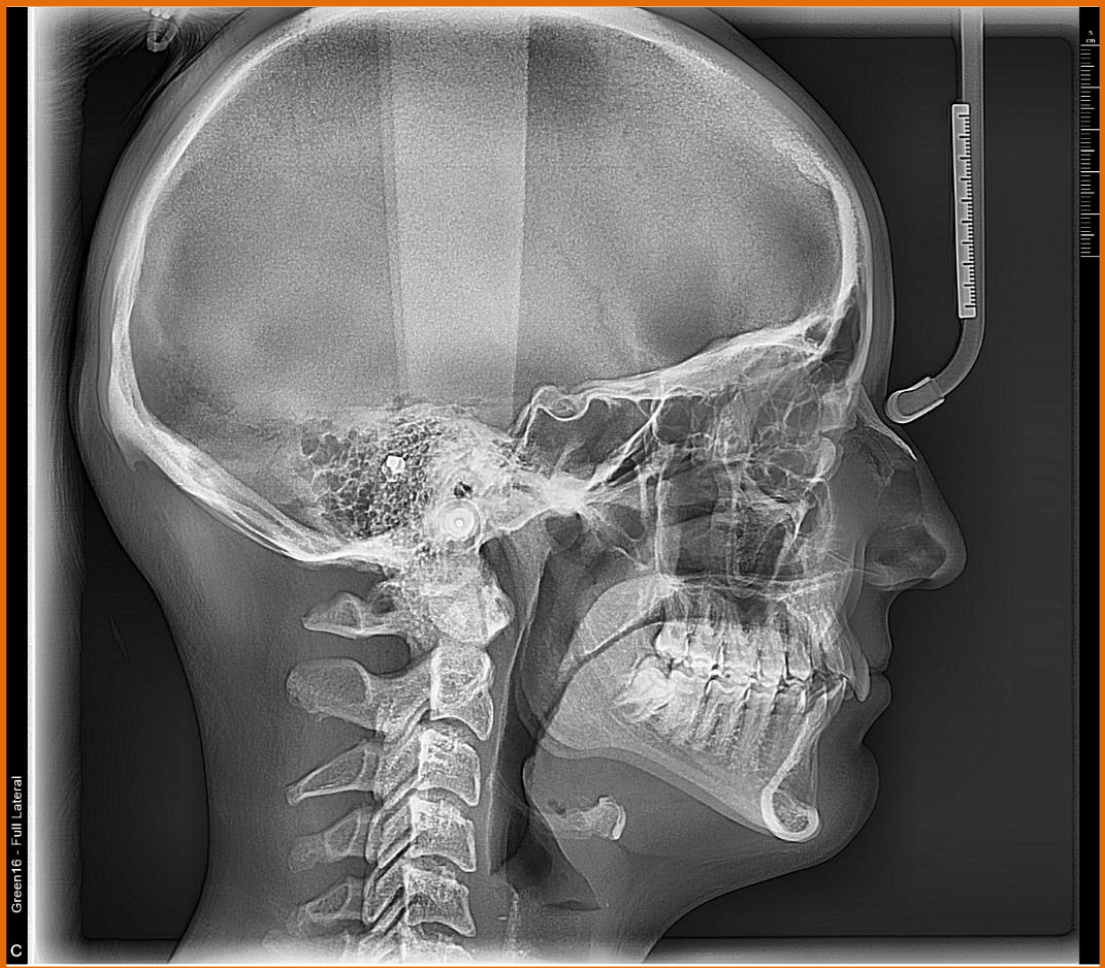

# 03-III. Lateral Ceph Image Capture

## 2D Ceph Image Capture Software – Pre-Capture Options:

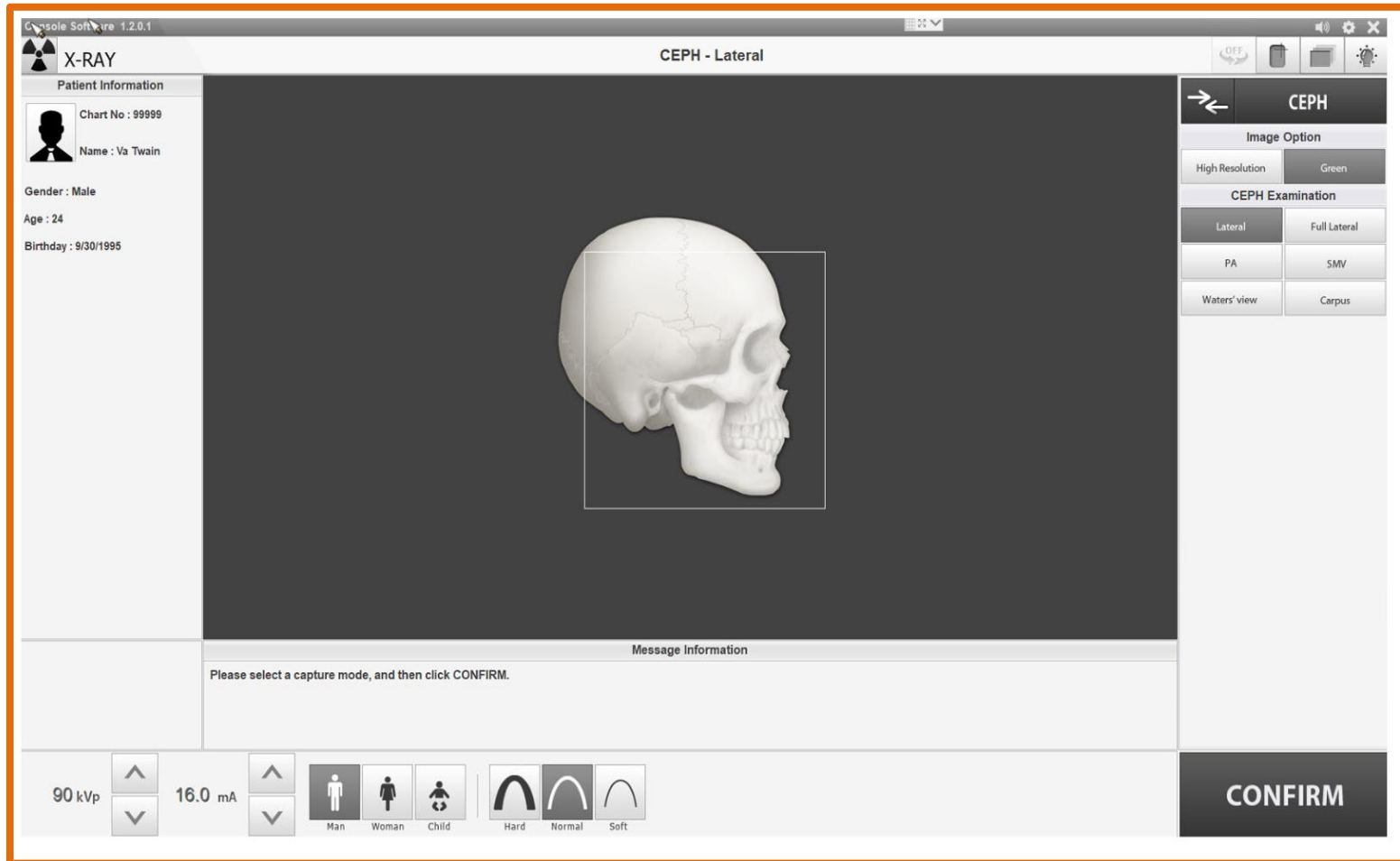

# 03-III. Lateral Ceph Image Capture

## 2D Ceph Image Capture Software – *Post Capture Options:*

The screenshot displays the 'X-RAY' console software interface. The main window shows a lateral cephalometric X-ray of a skull. The software title is 'Console Software 1.0.0.1' and the window title is 'CEPH - Lateral'. On the left, the 'Patient Information' panel includes a chart number (99999), name (Va Tech), gender (Male), age (31), and birthday (1985-07-01). Below the image, technical data shows DAP (55.725219 mGy x cm^2), scan-time (12.0 Sec), and exposure-time (11.5 Sec). A 'Message Information' dialog box asks 'Do you want to save the selected image?' with 'Save' and 'Cancel' buttons. On the right, a 'CEPH' control panel offers 'Image Option' (High Resolution, Green) and 'CEPH Examination' (Lateral, Full Lateral, PA, SMV, Waters' view, Carpus). At the bottom, a control bar features '90 kVp' and '16.0 mA' with up/down arrows, patient icons (Man, Woman, Child), filter icons (Hard, Normal, Soft), and a 'READY' indicator.



## 03-III. Lateral Ceph Appliances and Positioning

---

### CEPH OBJECTIVE : *“Natural Head Position”*

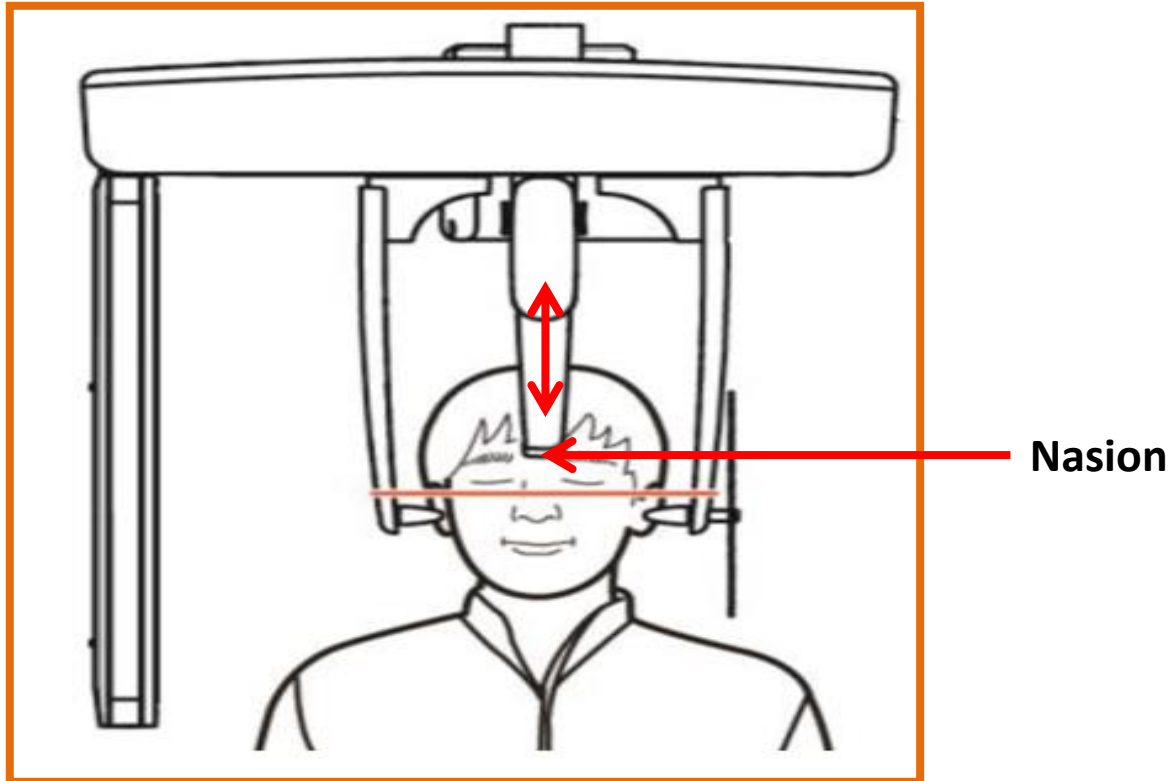

#### Ceph Lateral View

- Align Ear Rods so Patient Doesn't Move
- Nasion Bar at Bridge of Nose

## 03-III. Lateral Ceph Appliances and Positioning

---

### CEPH OBJECTIVE : “*Natural Head Position*”

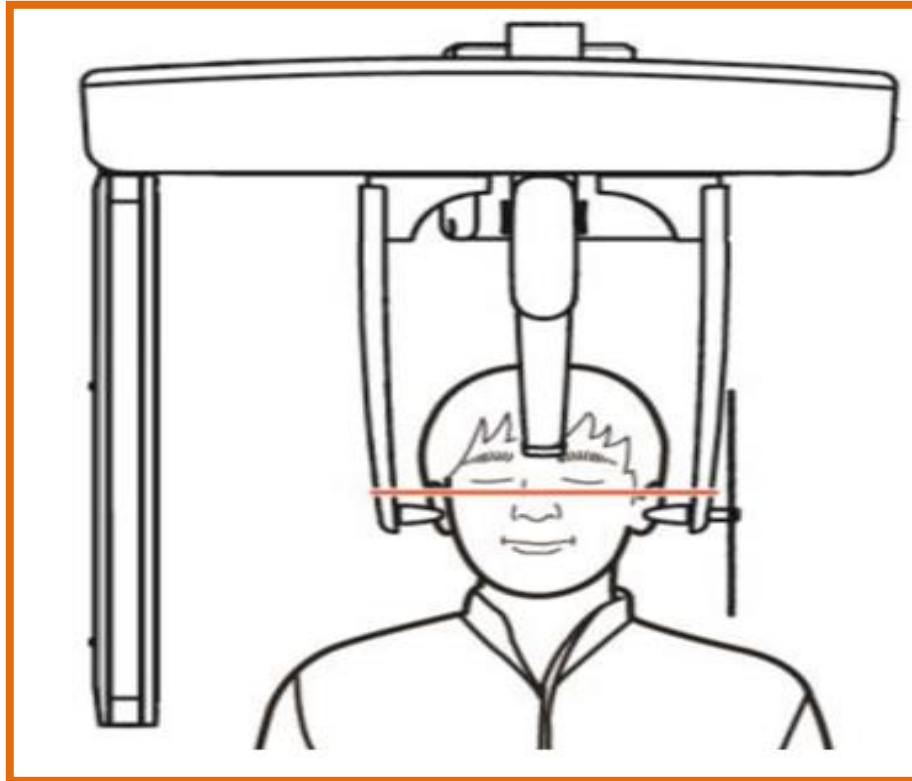

#### Natural Head Position

- Occlusal plane should be 10 degrees
- Frankfurt plane should be parallel to the floor (Super Tragus to inferior Orbital Rim)

# 03-IV. Customer Learning Center

Visit our Vatech Customer Learning Portal for Video Tutorials regarding the Imaging Systems and Software

[www.vatechamerica.com](http://www.vatechamerica.com)

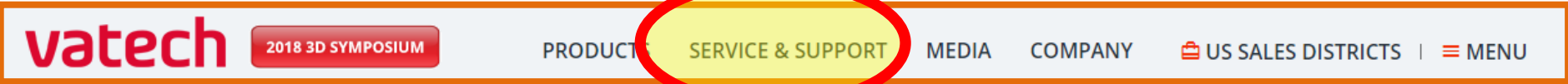

CUSTOMER LEARNING CENTER  
Product supports, documents and downloads.

IMAGING SYSTEMS	INTRAORAL IMAGING	SOFTWARE
<ul style="list-style-type: none"><li>PaX-i</li><li>PaX-i Insight</li><li>i3D Smart</li><li>i3D Smart RC</li><li>PaX-i3D</li><li>Green CT</li><li>Green CT 2</li><li>i3D Premium</li></ul>	<ul style="list-style-type: none"><li>Ezray Air W</li><li>HD Sensor</li></ul>	<ul style="list-style-type: none"><li>Ez3D-i</li><li>Ez3D Plus</li><li>EzDent-i</li><li>EzDent 4</li></ul>

Have an account?  
Please login to get our support or  
[Create a new account](#)

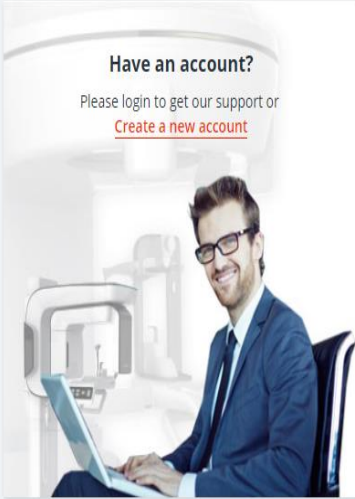

LOGIN

Remember me [Forgot password?](#)

**Choose Category: Imaging System**

**Login or register for New User**

---

**Thank You**

***The World's Best  
Dental Imaging Company***